

Distributed by:

JAMECO[®]
ELECTRONICS

www.Jameco.com ♦ 1-800-831-4242

The content and copyrights of the attached
material are the property of its owner.

Jameco Part Number 920510

Stacked Metallized Film Capacitor

Type: **ECQV**

Designed for application where high density insertion of components is required.

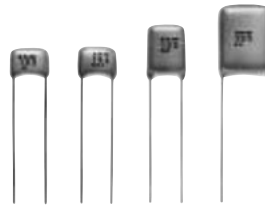

■ Features

- ◆ High volumetric efficiency
- ◆ Excellent electrical characteristics in non-inductive construction
- ◆ Wide range for automatic insertion

■ Recommended Applications

- ◆ General purpose usage
- ◆ Noise suppression for logic circuits

■ Explanation of Part Numbers

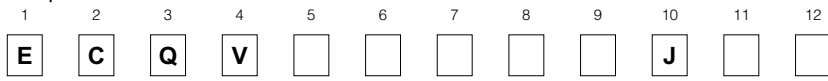

Product code Dielectric & construction Rated voltage Capacitance Cap. Tol. Suffix Suffix

50VDC	63VDC	100VDC
1H	1J	1

Taping				Crimped lead	
Ammo		Reel		Type1	Type2
Straight	Crimped	Straight	Crimped	style N	style T
2	3	5	9	Blank	W

■ Specifications

Category temp. range	-40 to +85°C
Rated voltage	50VDC, 63VDC, 100VDC
Capacitance range	0.01 to 2.2 μF
Capacitance tolerance	±5%(J)
Dissipation factor	1.0%max.(20°C 1kHz)
Withstand voltage	Between terminals : Rated volt.(VDC)×150% 60s
Insulation resistance	$C \leq 0.33\mu\text{F} : 3000\text{M}\Omega \text{ min.}$ (20°C, 50VDC 60s ECQV1H, ECQV1J) $C > 0.33\mu\text{F} : 1000\text{M}\Omega \cdot \mu\text{Fmin.}$ (20°C, 100VDC 60s ECQV1)

■ Dimensions in mm(not to scale)

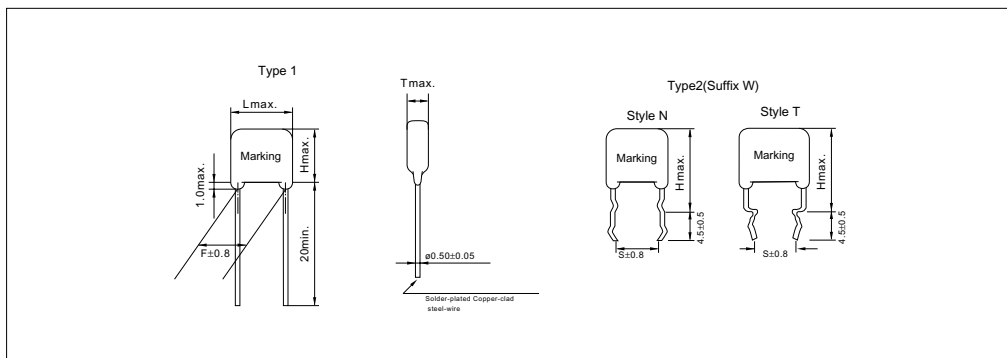

■ Packaging Specifications for Bulk Package

Packing quantity: 100pcs./bag

■ Taping Specifications for Automatic Insertion

● Taping style

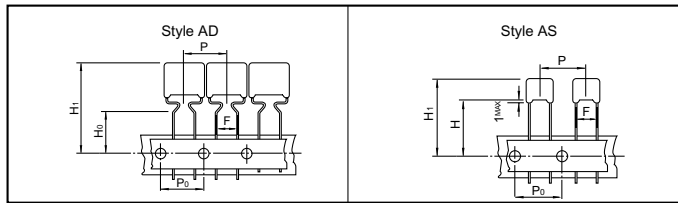

● Packaging Specifications

Type	Rated volt.	Cap. range (μF)	Taping style							Packing
			AD	AS	B	C	D	E		
ECQV (L)	50VDC	0.01 to 2.2	○							Ammo
		0.01 to 1.0		○						Ammo
		0.01 to 2.2	○							Reel
		0.01 to 1.0		○						Reel
ECQV (M)	63VDC	0.01 to 1.0	○							Ammo
		0.01 to 1.0		○						Reel
		0.01 to 0.15			○					Reel
		0.01 to 0.47	○							Ammo
	100VDC	0.01 to 0.47	○							Reel
		0.01 to 0.1			○					Ammo
		0.01 to 0.1				○				Reel
		0.01 to 0.1	○							Reel

● Lead Spacing

Style	Lead Spacing
AD	5.0mm
AS	5.0mm

※ See the column "Rating, Dimensions & Quantity Box" for packing quantity.

■ Rating, Dimensions & Quantity/Ammo Box or Reel

● Type ECQV(L) Rated voltage : 50VDC

Part No.	Cap. (μF)	Dimensions (mm)								Quantity	
		L _{max.}	T _{max.}	H _{max.}		F	S	ød	Ammo	Reel	
				Type-1	Type-2						
ECQV1H103JL()	0.01	7.3	3.2	5.0	9.0	5.0	5.0	0.50	2000	2000	
ECQV1H123JL()	0.012	7.3	3.2	5.0	9.0	5.0	5.0	0.50			
ECQV1H153JL()	0.015	7.3	3.2	5.0	9.0	5.0	5.0	0.50			
ECQV1H183JL()	0.018	7.3	3.2	5.0	9.0	5.0	5.0	0.50			
ECQV1H223JL()	0.022	7.3	3.2	5.0	9.0	5.0	5.0	0.50			
ECQV1H273JL()	0.027	7.3	3.2	5.0	9.0	5.0	5.0	0.50			
ECQV1H333JL()	0.033	7.3	3.2	5.0	9.0	5.0	5.0	0.50			
ECQV1H393JL()	0.039	7.3	3.2	5.0	9.0	5.0	5.0	0.50			
ECQV1H473JL()	0.047	7.3	3.2	5.0	9.0	5.0	5.0	0.50			
ECQV1H563JL()	0.056	7.3	3.2	5.0	9.0	5.0	5.0	0.50			
ECQV1H683JL()	0.068	7.3	3.2	5.0	9.0	5.0	5.0	0.50			
ECQV1H823JL()	0.082	7.3	3.6	5.0	9.0	5.0	5.0	0.50			
ECQV1H104JL()	0.1	7.3	4.0	5.0	9.0	5.0	5.0	0.50			
ECQV1H124JL()	0.12	7.3	4.0	5.0	9.0	5.0	5.0	0.50			
ECQV1H154JL()	0.15	7.3	4.4	5.5	9.5	5.0	5.0	0.50			
ECQV1H184JL()	0.18	7.3	4.5	5.5	9.5	5.0	5.0	0.50			
ECQV1H224JL()	0.22	7.3	4.8	5.5	9.5	5.0	5.0	0.50			
ECQV1H274JL()	0.27	7.3	4.6	7.0	11.0	5.0	5.0	0.50			
ECQV1H334JL()	0.33	7.3	5.2	7.0	11.0	5.0	5.0	0.50			
ECQV1H394JL()	0.39	7.3	5.7	7.3	11.3	5.0	5.0	0.50			
ECQV1H474JL()	0.47	7.3	6.0	7.3	11.3	5.0	5.0	0.50			
ECQV1H564JL()	0.56	7.3	5.8	10.0	14.0	5.0	5.0	0.50			
ECQV1H684JL()	0.68	7.3	6.5	10.0	14.0	5.0	5.0	0.50			
ECQV1H824JL()	0.82	7.3	6.8	10.0	14.0	5.0	5.0	0.50			
ECQV1H105JL()	1.0	7.3	8.0	11.0	15.0	5.0	5.0	0.50			
ECQV1H125JL()	1.2	10.2	6.5	10.0	14.0	7.5	5.0	0.50			
ECQV1H155JL()	1.5	10.2	7.2	10.0	14.0	7.5	5.0	0.50			
ECQV1H185JL()	1.8	10.2	7.2	12.0	16.5	7.5	5.0	0.50			
ECQV1H225JL()	2.2	10.2	7.9	12.0	16.5	7.5	5.0	0.50			

— Suffix for lead crimped or taped type

styleN:0.01 to 1.0 μF
styleT:1.2 to 2.2 μF

■ Rating, Dimensions & Quantity/Ammo Box or Reel

● Type ECQV(M) Rated voltage : 63VDC

Part No.	Cap. (μ F)	Dimensions (mm)							Quantity	
		L _{max.}	T _{max.}	H _{max.}		F	S	ϕ d	Ammo	Reel
				Type-1	Type-2	Type-1	Type-2			
ECQV1J103JM()	0.01	7.5	3.2	6.8	10.8	5.0	5.0	0.50	2000	2000
ECQV1J123JM()	0.012	7.5	3.2	6.8	10.8	5.0	5.0	0.50		
ECQV1J153JM()	0.015	7.5	3.2	6.8	10.8	5.0	5.0	0.50		
ECQV1J183JM()	0.018	7.5	3.2	6.8	10.8	5.0	5.0	0.50		
ECQV1J223JM()	0.022	7.5	3.2	6.8	10.8	5.0	5.0	0.50		
ECQV1J273JM()	0.027	7.5	3.2	6.8	10.8	5.0	5.0	0.50		
ECQV1J333JM()	0.033	7.5	3.2	6.8	10.8	5.0	5.0	0.50		
ECQV1J393JM()	0.039	7.5	3.2	6.8	10.8	5.0	5.0	0.50		
ECQV1J473JM()	0.047	7.5	3.2	6.8	10.8	5.0	5.0	0.50		
ECQV1J563JM()	0.056	7.5	3.2	6.8	10.8	5.0	5.0	0.50		
ECQV1J683JM()	0.068	7.5	3.2	6.8	10.8	5.0	5.0	0.50		
ECQV1J823JM()	0.082	7.5	3.2	6.8	10.8	5.0	5.0	0.50		
ECQV1J104JM()	0.1	7.5	3.2	7.0	11.0	5.0	5.0	0.50		
ECQV1J124JM()	0.12	7.5	3.8	7.0	11.0	5.0	5.0	0.50		
ECQV1J154JM()	0.15	7.5	4.1	7.0	11.0	5.0	5.0	0.50		
ECQV1J184JM()	0.18	10.2	3.5	9.0	14.0	7.5	5.0	0.50		
ECQV1J224JM()	0.22	10.2	3.5	9.0	14.0	7.5	5.0	0.50		
ECQV1J274JM()	0.27	10.2	3.5	9.0	14.0	7.5	5.0	0.50		
ECQV1J334JM()	0.33	10.2	3.8	9.0	14.0	7.5	5.0	0.50		
ECQV1J394JM()	0.39	10.2	4.0	9.0	14.0	7.5	5.0	0.50		
ECQV1J474JM()	0.47	10.2	4.5	9.0	14.0	7.5	5.0	0.50		
ECQV1J564JM()	0.56	10.2	4.9	9.0	14.0	7.5	5.0	0.50		
ECQV1J684JM()	0.68	10.2	5.5	10.0	15.0	7.5	5.0	0.50		
ECQV1J824JM()	0.82	10.2	6.1	10.0	15.0	7.5	5.0	0.50		
ECQV1J105JM()	1.0	10.2	6.9	10.0	15.0	7.5	5.0	0.50		

StyleN:0.01 to 0.15 μ F
StyleT:0.18 to 1.0 μ F

● Type ECQV(M) Rated voltage : 100VDC

Part No.	Cap. (μ F)	Dimensions (mm)							Quantity	
		L _{max.}	T _{max.}	H _{max.}		F	S	ϕ d	Ammo	Reel
				Type-1	Type-2	Type-1	Type-2			
ECQV1103JM()	0.01	7.5	3.2	7.0	12.0	5.0	5.0	0.50	2000	2000
ECQV1123JM()	0.012	7.5	3.2	7.0	12.0	5.0	5.0	0.50		
ECQV1153JM()	0.015	7.5	3.2	7.0	12.0	5.0	5.0	0.50		
ECQV1183JM()	0.018	7.5	3.2	7.0	12.0	5.0	5.0	0.50		
ECQV1223JM()	0.022	7.5	3.2	7.0	12.0	5.0	5.0	0.50		
ECQV1273JM()	0.027	7.5	3.2	7.0	12.0	5.0	5.0	0.50		
ECQV1333JM()	0.033	7.5	3.2	7.0	12.0	5.0	5.0	0.50		
ECQV1393JM()	0.039	7.5	3.2	7.0	12.0	5.0	5.0	0.50		
ECQV1473JM()	0.047	7.5	3.2	7.0	12.0	5.0	5.0	0.50		
ECQV1563JM()	0.056	7.5	3.2	7.0	12.0	5.0	5.0	0.50		
ECQV1683JM()	0.068	7.5	4.0	7.0	12.0	5.0	5.0	0.50		
ECQV1823JM()	0.082	7.5	4.1	7.0	12.0	5.0	5.0	0.50		
ECQV1104JM()	0.1	7.5	4.5	7.0	12.0	5.0	5.0	0.50		
ECQV1124JM()	0.12	10.2	3.3	9.0	14.0	7.5	5.0	0.50		
ECQV1154JM()	0.15	10.2	3.3	9.0	14.0	7.5	5.0	0.50		
ECQV1184JM()	0.18	10.2	3.6	9.0	14.0	7.5	5.0	0.50		
ECQV1224JM()	0.22	10.2	4.0	9.0	14.0	7.5	5.0	0.50		
ECQV1274JM()	0.27	10.2	4.2	9.0	14.0	7.5	5.0	0.50		
ECQV1334JM()	0.33	10.2	4.8	10.0	15.0	7.5	5.0	0.50		
ECQV1394JM()	0.39	10.2	5.5	10.0	15.0	7.5	5.0	0.50		
ECQV1474JM()	0.47	10.2	6.8	10.5	15.5	7.5	5.0	0.50		

↑ Suffix for lead crimped or taped type

StyleN:0.01 to 0.1 μ F



ECQV(M) Type 100VDC Series (Polyester Film)

Erectrical Characteristics <Typical Data>

Temperature Characteristics

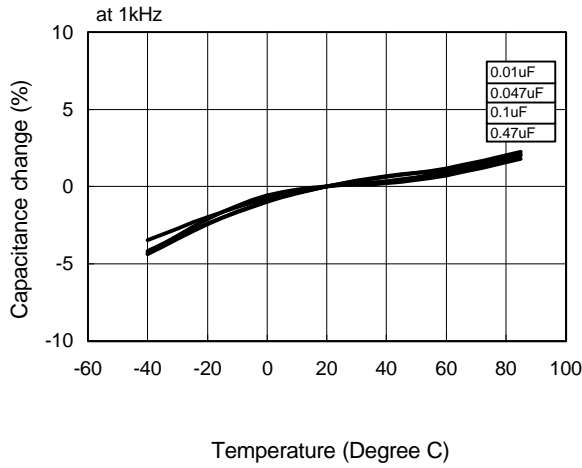

Frequency Characteristics

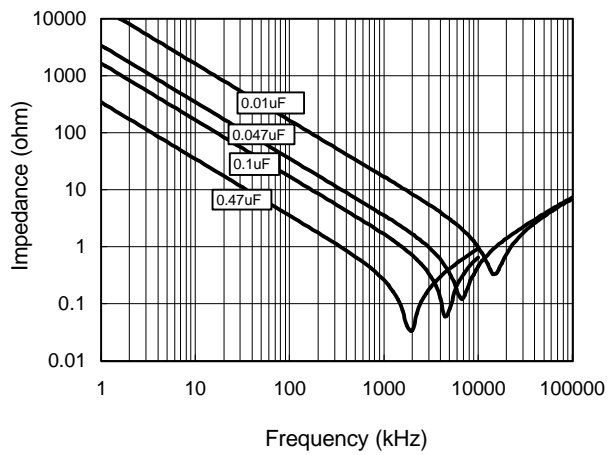
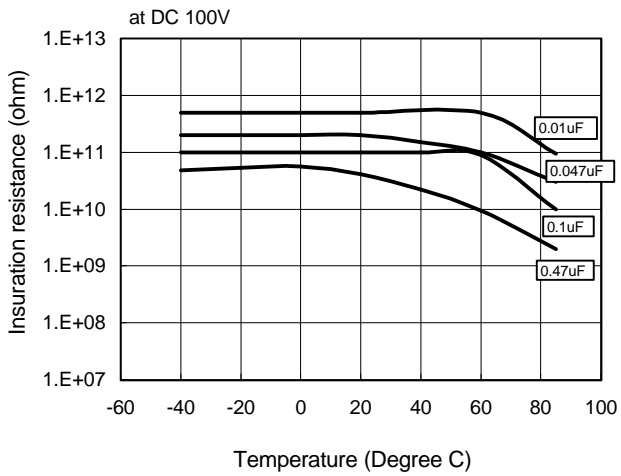
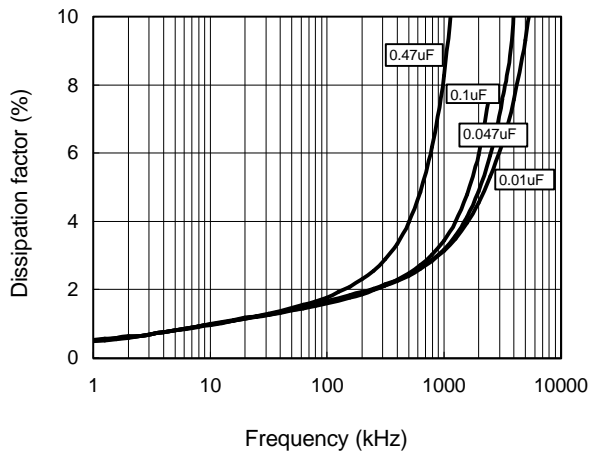
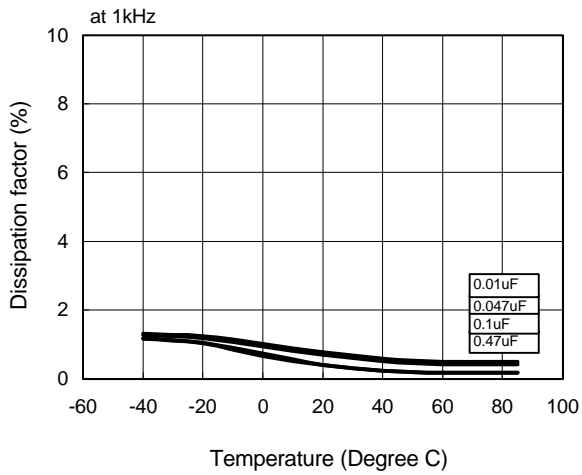
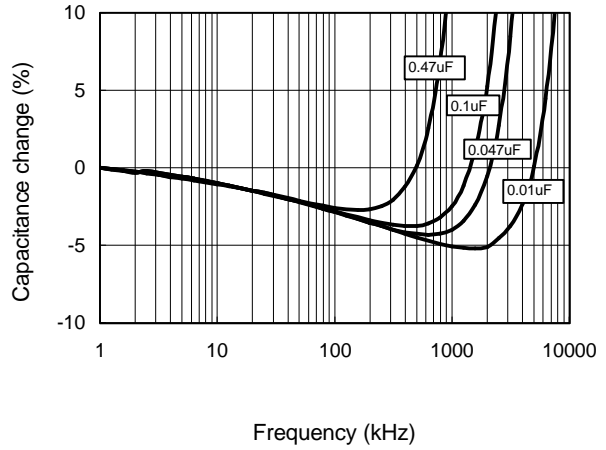



ECQV(M) Type 100VDC Series (Polyester Film)

Applicable Specifications

Permissible Current

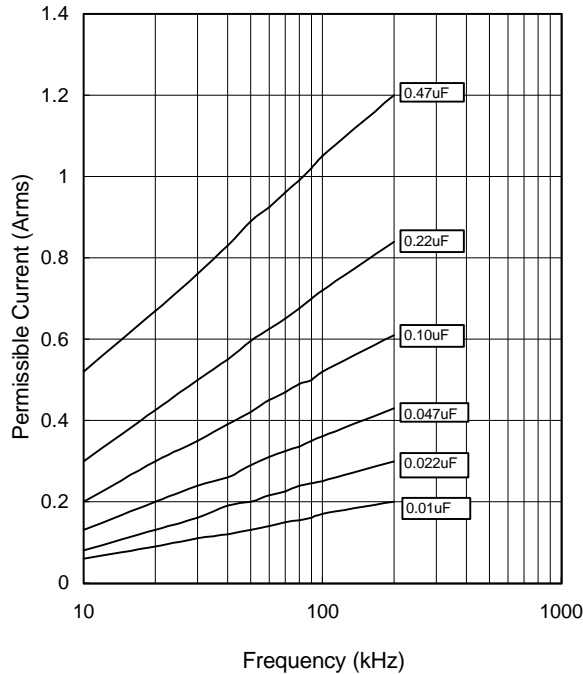

Permissible Voltage

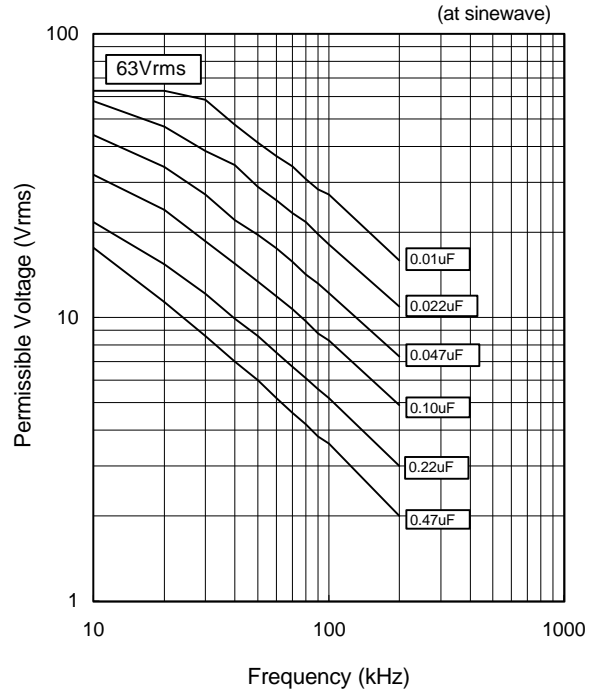

Pulse Handling Capability (dV/dt)

(Max 10000cycles)

Rating Voltage	Capacitance Value(uF)	Code	dV/dt(V/us)	Current(o-p) (A)
100VDC	0.010	103	55	0.55
	0.015	153		0.83
	0.022	223		1.21
	0.033	333		1.82
	0.047	473		2.59
	0.068	683	43	3.74
	0.100	104		5.50
	0.150	154		6.45
	0.220	224		9.46
	0.330	334		14.19
0.470	474	20.21		

Voltage Derating by Temperature

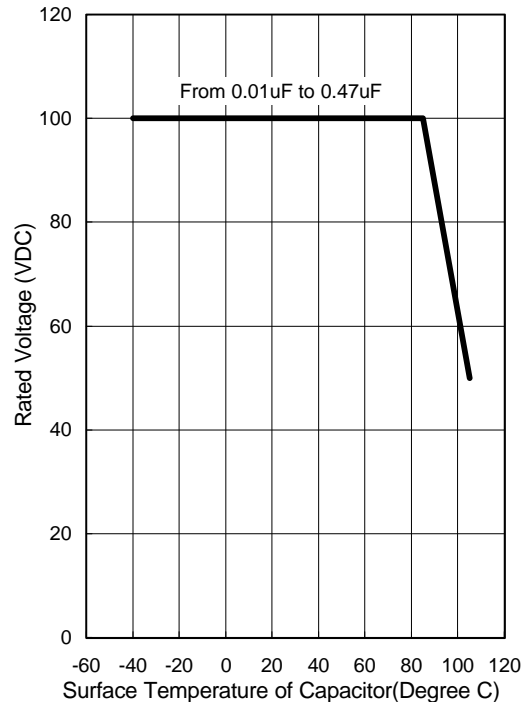

* Please consult Panasonic if your condition exceeds the above spec.

ECQV(L) Type 50VDC Series (Polyester Film)

Erectrical Characteristics <Typical Data>

Temperature Characteristics

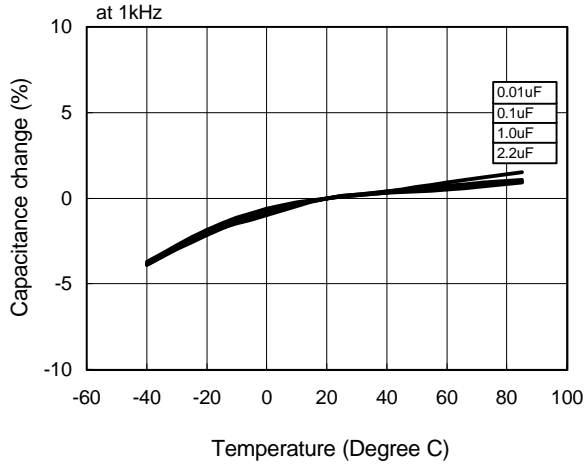

Frequency Characteristics

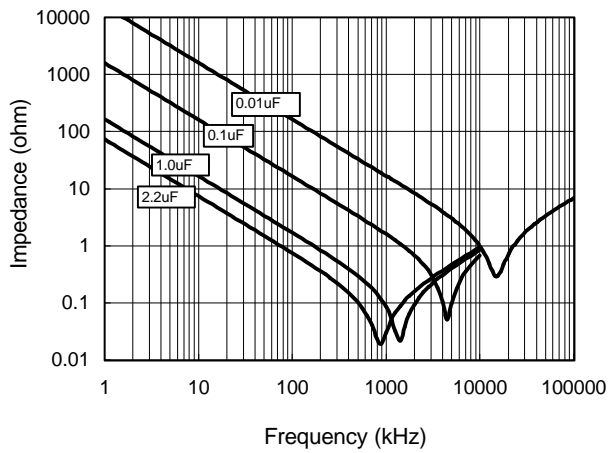
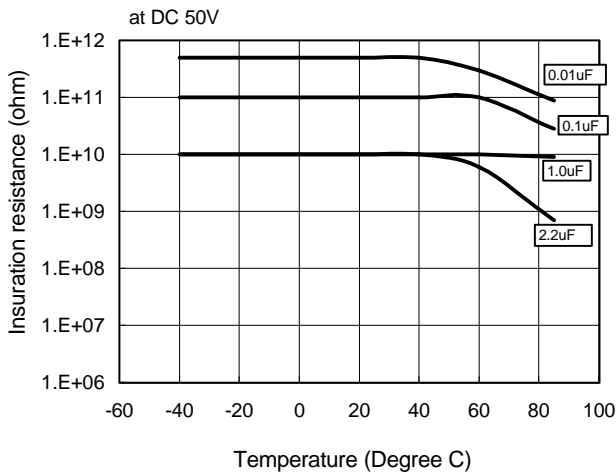
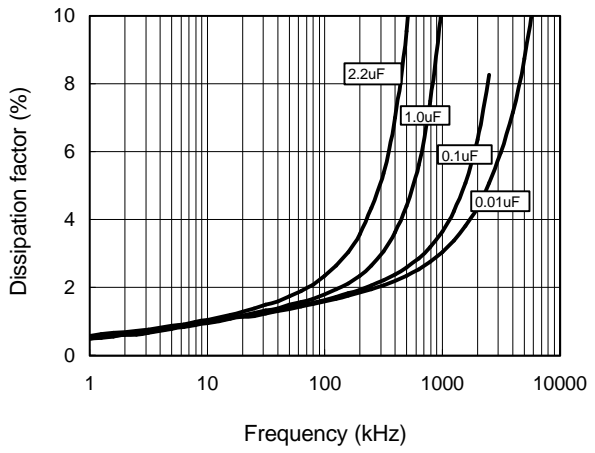
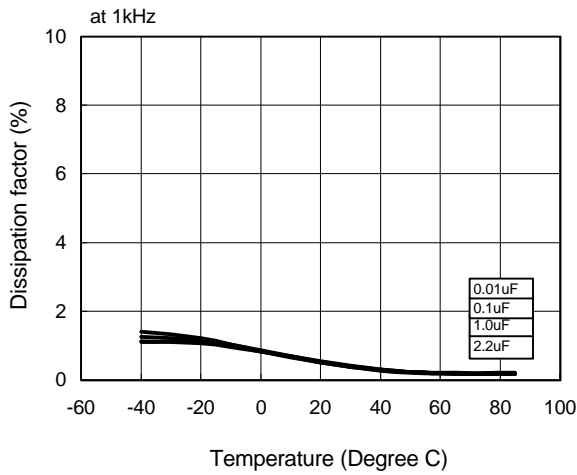
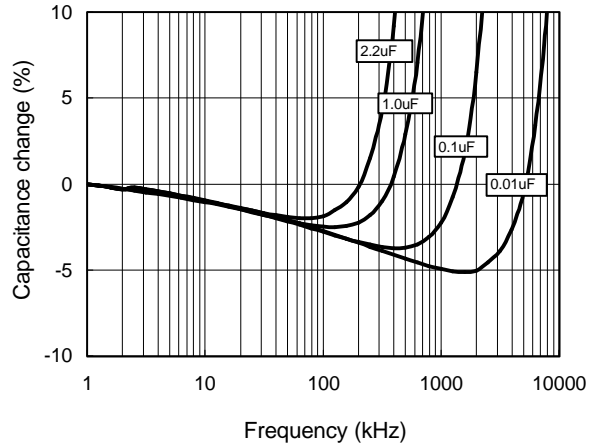

ECQV(L) Type 50VDC Series (Polyester Film)

Applicable Specifications

Permissible Current

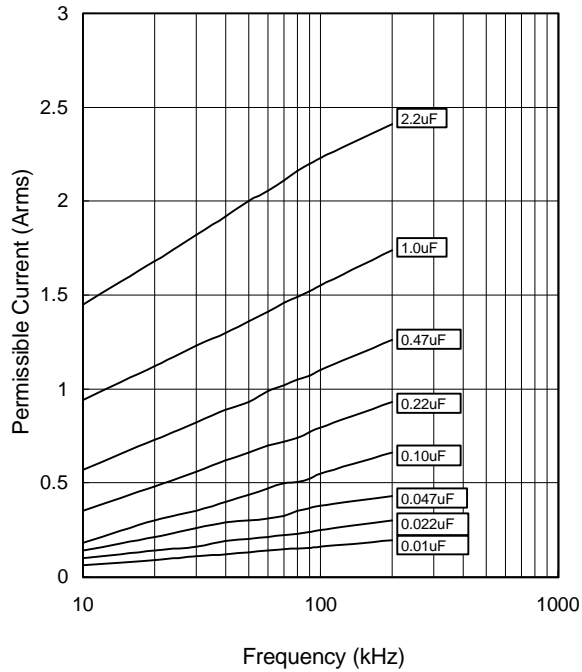

Permissible Voltage

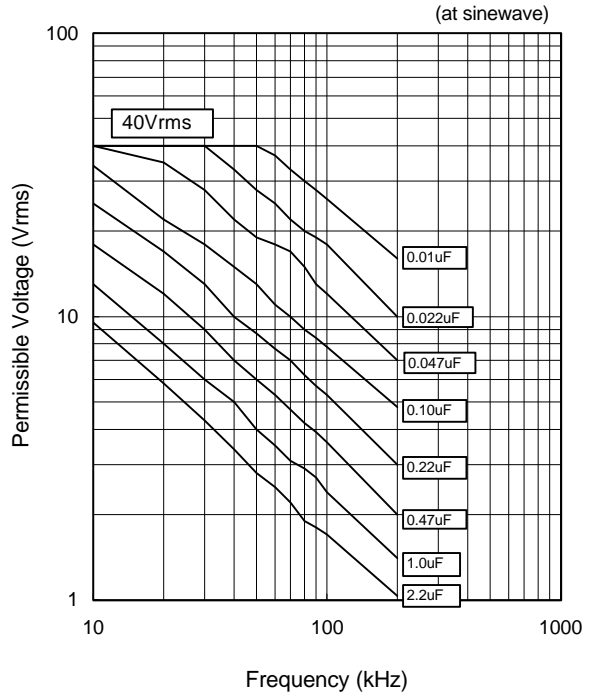

Pulse Handling Capability (dV/dt)

(Max 10000cycles)

Rating Voltage	Capacitance Value(uF)	Code	dV/dt(V/us)	Current(o-p) (A)
50VDC	0.010	103	37	0.37
	0.015	153		0.56
	0.022	223		0.81
	0.033	333		1.22
	0.047	473		1.74
	0.068	683		2.52
	0.100	104	32	3.20
	0.150	154		4.80
	0.220	224		7.04
	0.330	334		10.56
	0.470	474		15.04
	0.680	684	21.76	12
	1.000	105	32.00	
	1.500	155	18.00	
2.200	225	26.40		

Voltage Derating by Temperature

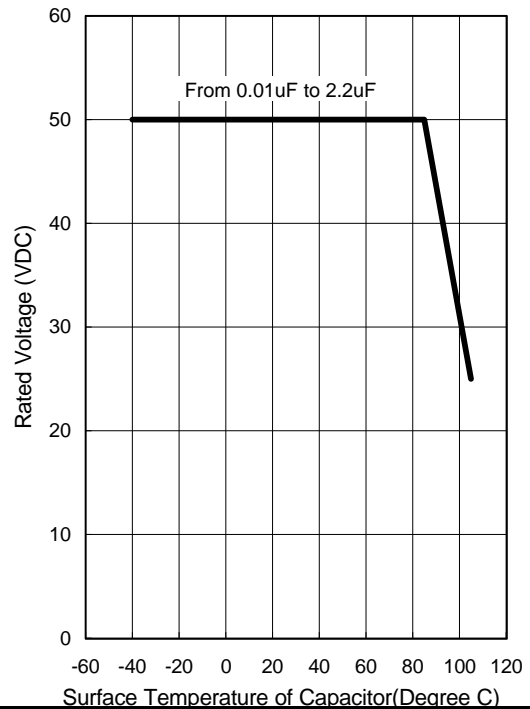

* Please consult Panasonic if your condition exceeds the above spec.



ECQV(M) Type 63VDC Series (Polyester Film)

Erectrical Characteristics <Typical Data>

Temperature Characteristics

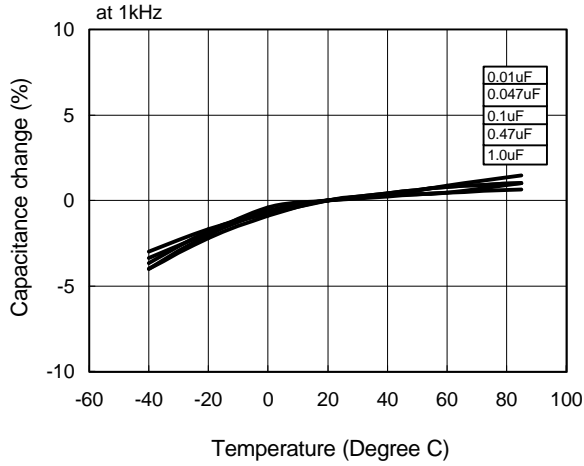

Frequency Characteristics

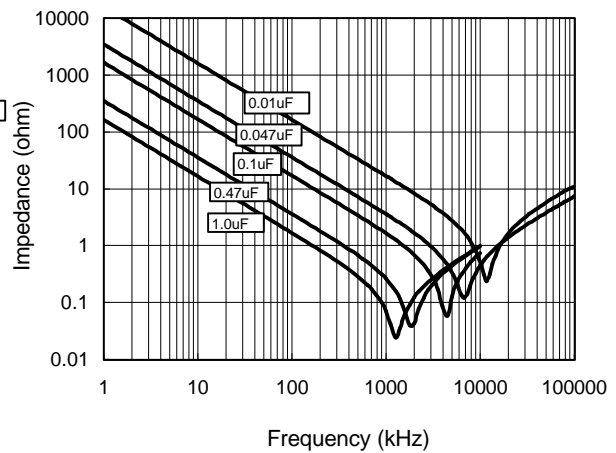
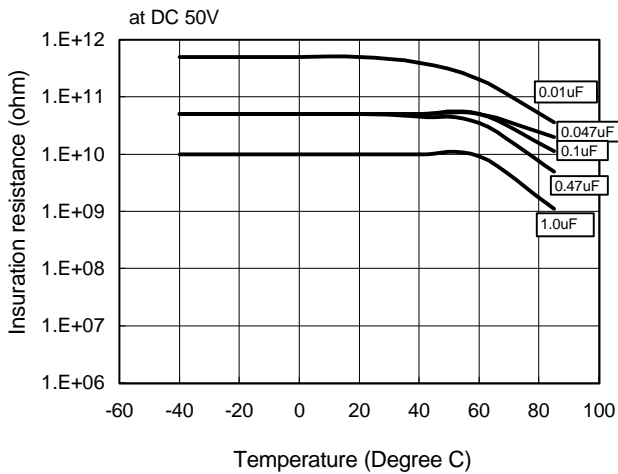
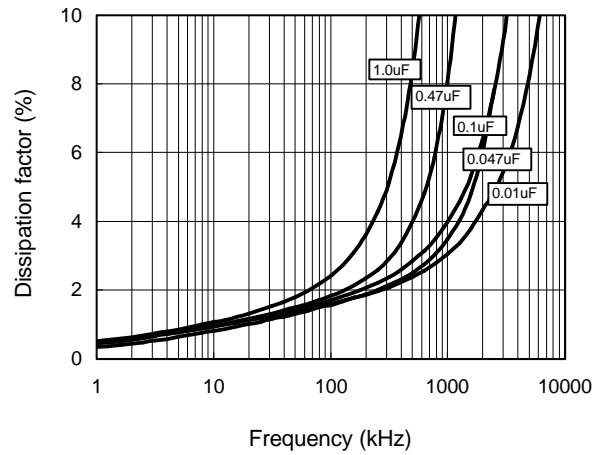
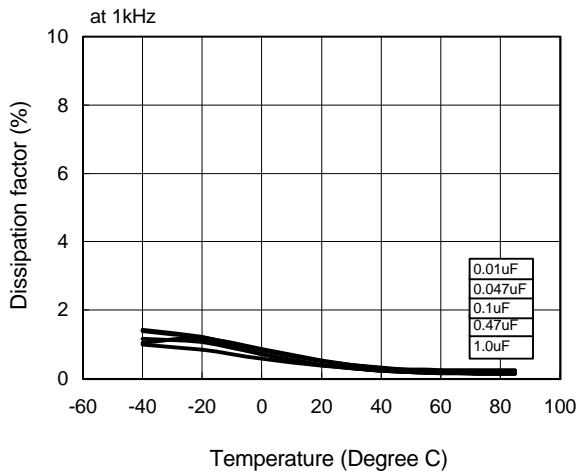
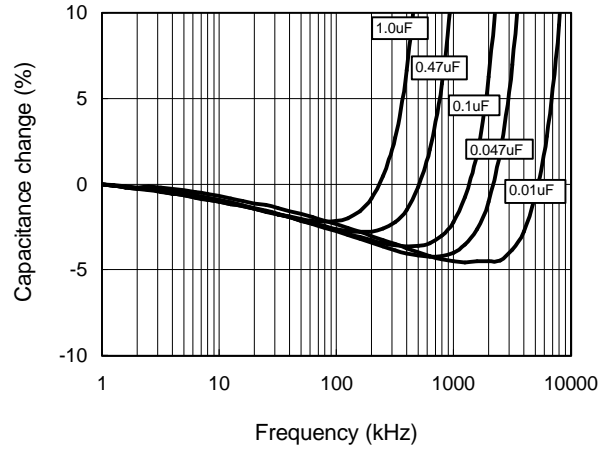

ECQV(M) Type 63VDC Series (Polyester Film)

Applicable Specifications

Permissible Current

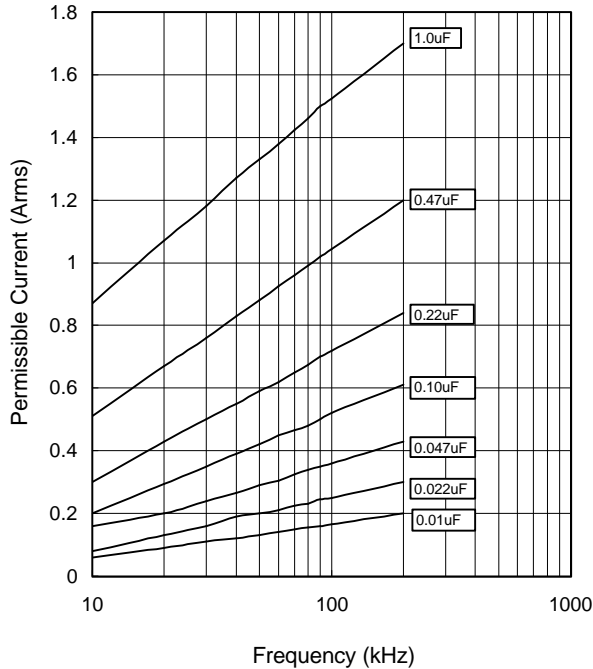

Permissible Voltage

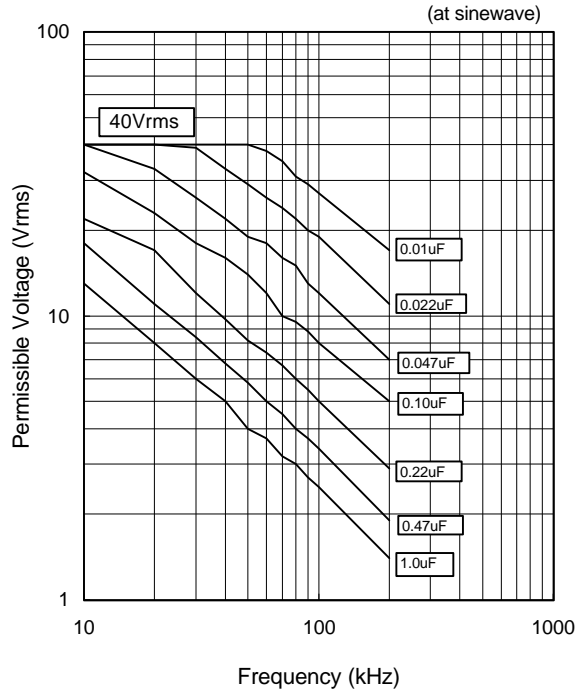

Pulse Handling Capability (dV/dt)

(Max 10000cycles)

Rating Voltage	Capacitance Value(uF)	Code	dV/dt(V/us)	Current(o-p) (A)
63VDC	0.010	103	49	0.49
	0.015	153		0.74
	0.022	223		1.08
	0.033	333		1.62
	0.047	473		2.30
	0.068	683		3.33
	0.100	104		4.90
	0.150	154	45	7.35
	0.220	224		9.90
	0.330	334		14.85
	0.470	474	33	21.15
	0.680	684		30.60
	1.000	105	33	33.00

Voltage Derating by Temperature

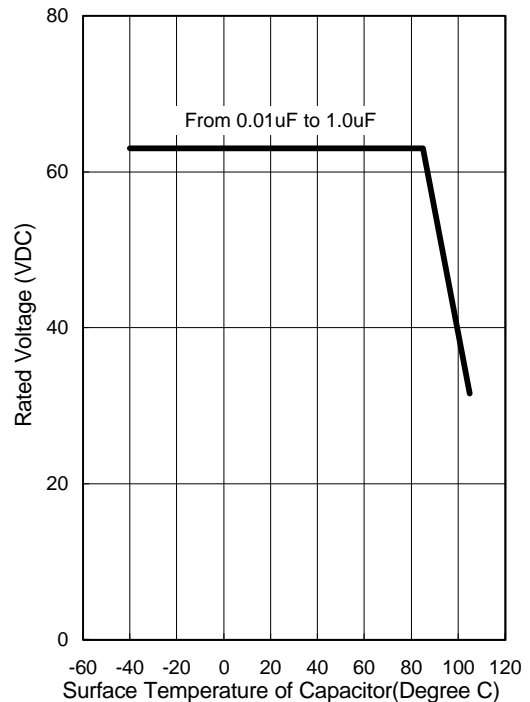

* Please consult Panasonic if your condition exceeds the above spec.