

Distributed by:

JAMECO[®]
ELECTRONICS

www.Jameco.com ♦ 1-800-831-4242

The content and copyrights of the attached
material are the property of its owner.

Jameco Part Number 109146

.200"(5.08mm) Pitch Power Connector

ROHS

CW390 Series (old item number : JS-1114-04WS-R)

- * Poles: 4
- * Material: Insulator: NYLON 66 UL94V-2
- * Material: Post: Brass, tin plated
- * Mates with CH390-04 CH396-04 series housing

SPECIFICATIONS

- * Current rating: 5A AC, DC
- * Voltage rating: 250V AC, DC
- * Temperature range: -25°C~+105°C
- * Insulation resistance: 1,000MΩ min.
- * Withstand voltage: 1500V AC/minute
- * Applicable PC board thickness: .063"(1.6mm)

CW390S-04 SERIES

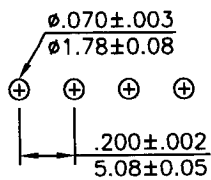
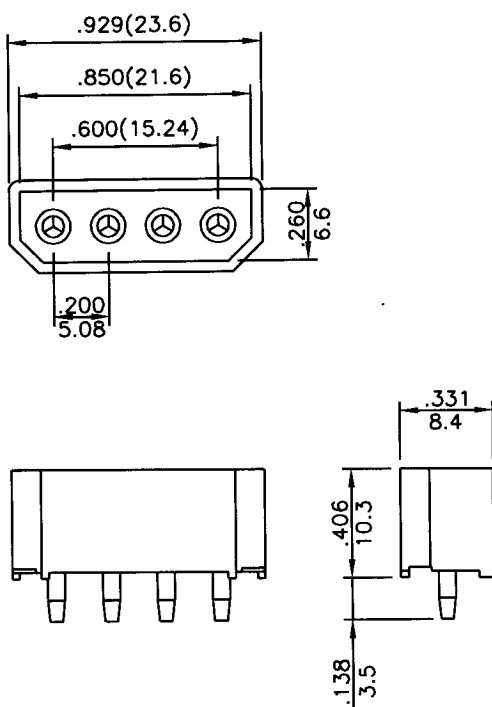

P.C Board Layout

CW390R-04 SERIES (JS-1114-04WR-R)

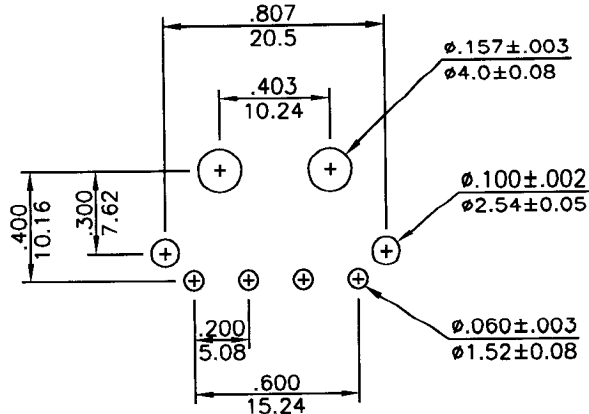
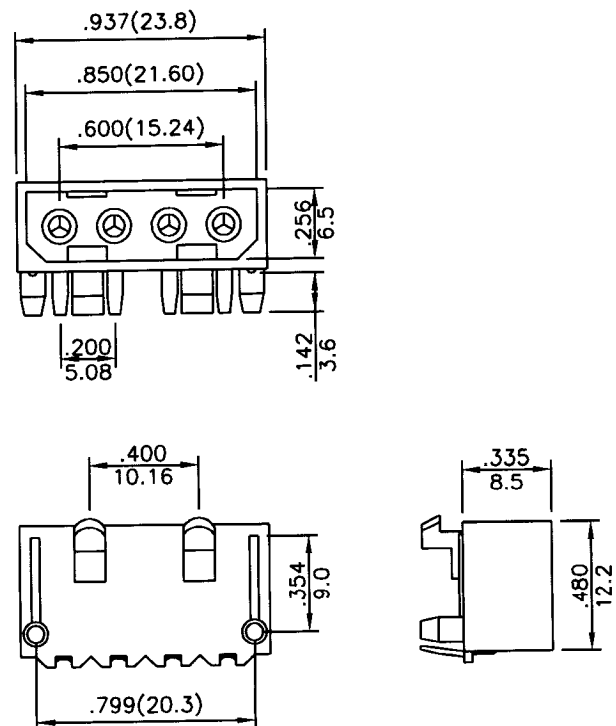

P.C Board Layout