

- ▶ Products
 - ▶ Design Resources
 - ▶ Technical Info
 - ▶ Global Sales
 - ▶ News/Events
 - Useful Links---
- ▶ RoHS

Quick Reference

Search by part #

Check distributor part inventory

Stock Check
CLICK HERE!

Products

Browse Heat sinks

- By Device -
- By Product Line -
- Attachment Methods
- Interface Materials -
- Accessories -

Useful Links

- [MSDS Safety Sheets](#)
- [RoHS Initiative](#)
- [Directions](#)
- [How to order?](#)
- [Find Sales Rep](#)
- [Find Distributor](#)
- [Sample Request](#)
- [Quote Request](#)
- [Catalog Request](#)
- [Building a part #](#)
- [Part # Cross Ref](#)

Mounting Kits

- Pre-packaged in heat-sealed plastic bags for use on assembly line.
- Stock mounting hardware using one number for better control and identification. Part number can be printed on the bag if requested.
- Standard kit contains Thermalfilm insulator. For high maximum operating temperatures (550°C), order a mica insulator by adding suffix letter "M" to the part number. For electrical isolation and excellent thermal resistance, use In-Sil-8 for an insulator by adding suffix letter "S" to the part number.
- Other insulator materials available include: hard anodized aluminum and aluminum oxide.
- Refer to proper product section for drawings of insulators and shoulder washers used in the mounting kits.

TO-220 Mounting Kit

Part Number	Properties	RoHS	PCN
4880G	Thermalfilm	RoHS <input checked="" type="checkbox"/> Compliant	Product Change Notice
4880MG	Mica Insulator	RoHS <input checked="" type="checkbox"/> Compliant	Product Change Notice
4880SG	Thermalsil III	RoHS <input checked="" type="checkbox"/> Compliant	Product Change Notice



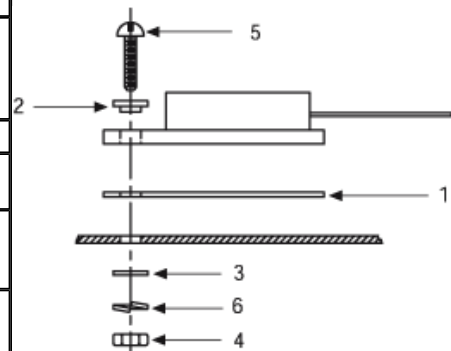



Item	Qty	Description	Part Number
1	1	Insulator Thermalfilm Mica In Sil-8	43-77-9 (56-77-9) (53-77-9)
2	1	Shoulder Washer	7721-7PPS
3	1	Flat Washer #4	MS15795-804
4	1	No. 4-40 UNC-2B Hex Nut	MS35649-244
5	1	No. 4-40 UNC-2A X 1/2 Long Phillips Pan Head Screw	MS51957-17
6	1	Lockwasher, No.4	MS35338-135



Note: Smooth side of flat washer should be placed against insulator when using the kit.

TO-3 Mounting Kit No.4804G

Part Number	Properties	RoHS	PCN

4804G	Thermalfilm	RoHS  Compliant	Product Change Notice 
4804MG	Mica Insulator	RoHS  Compliant	Product Change Notice 
4804SG	Thermalsil III	RoHS  Compliant	Product Change Notice 

Item	Qty	Description	Part Number
1	1	Insulator Thermalfilm Mica In Sil-8	43-03-2 (56-03-2) (53-03-2)
2	2	Shoulder Washer	7721-5PPS
3	2	Flat Washer #6	MS15795-805
4	2	No. 6-32 UNC-2B Hex Nut	MS35649-264
5	2	No. 6-32 UNC-2A X 1/2 Long Phillips Pan Head Screw	MS51957-30
6	2	Lockwasher, No.4	MS35338-136
7	1	Solder Lug	322-156

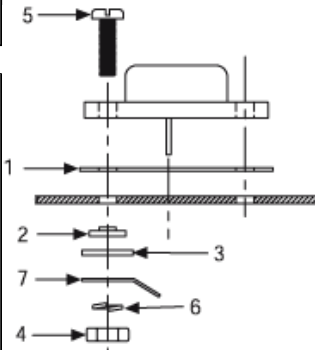

DO-4 Mounting Kit No.4860

Item	Qty	No. 4860 (Thermalfilm) No. 4860M (Mica Insulator) No. 4860S (Thermalsil III) Description	Part Number
1	2	Insulator Thermalfilm Mica Thermalsil III	43-02-10 (56-02-10) (56-02-10)
2	1	Busing, Teflon	110
3	1	Flat Washer #10	AN960-C10L
4	1	No. 10-32 UNF-2B Hex Nut	MS35650-304
5	1	Terminal, Locking	MS77066-4

DO-5 Mounting Kit No.4870

RoHS  Compliant

Item	Qty	No. 4870 (Thermalfilm) No. 4870M (Mica Insulator) Description	Part Number
1	2	Insulator: Thermalfilm Mica Thermalsil III	43-02-25 (56-02-93) (56-02-25)
2	1	Busing, Teflon	113
3	1	Flat Washer #1/4	AN960-C416L

4	1	No. 1/4-32 UNF-2B Hex Nut	MS51972-1
5	1	Terminal, Locking	MS77069-3

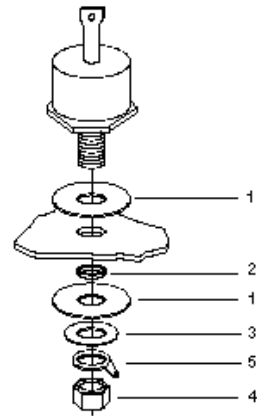

TO-66 Mounting Kit No.4813

Item	Qty	No. 4813 (Thermalfilm)	Part Number
1	1	Insulator: Thermalfilm	43-66-2
2	2	Shoulder Washer	7721-6PPS
3	2	Flat Washer #6	MS15795-803
4	2	No.4-40 UNC-2B Hex Nut	MS35649-244
5	2	No. 4-40 UNC-2A X 1/2 Long PPH Screw	MS1957-17
6	2	Lockwasher, No.6	MS35338-135
7	1	Solder Lug	322-.144