

Distributed by:

**JAMECO**<sup>®</sup>  
ELECTRONICS

**www.Jameco.com ♦ 1-800-831-4242**

The content and copyrights of the attached  
material are the property of its owner.

Jameco Part Number 12116NSC

# LM3080 Operational Transconductance Amplifier

## General Description

The LM3080 is a programmable transconductance block intended to fulfill a wide variety of variable gain applications. The LM3080 has differential inputs and high impedance push-pull outputs. The device has high input impedance and its transconductance ( $g_m$ ) is directly proportional to the amplifier bias current ( $I_{ABC}$ ).

High slew rate together with programmable gain make the LM3080 an ideal choice for variable gain applications such as sample and hold, multiplexing, filtering, and multiplying.

The LM3080N and LM3080AN are guaranteed from 0°C to +70°C.

## Features

- Slew rate (unity gain compensated): 50 V/ $\mu$ s
- Fully adjustable gain: 0 to  $g_m \cdot R_L$  limit
- Extended  $g_m$  linearity: 3 decades
- Flexible supply voltage range:  $\pm 2V$  to  $\pm 18V$
- Adjustable power consumption

## Schematic and Connection Diagrams

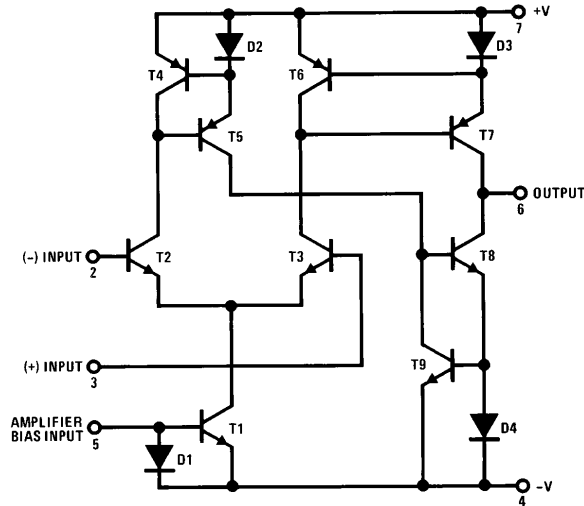

TL/H/7148-1

### Dual-In-Line Package

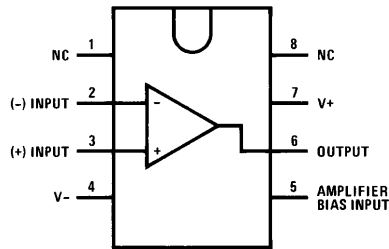

TL/H/7148-2

Order Number LM3080AN, LM3080M or LM3080N  
See NS Package Number M08A or N08E

## Absolute Maximum Ratings

If Military/Aerospace specified devices are required, please contact the National Semiconductor Sales Office/Distributors for availability and specifications.

Supply Voltage (Note 2)

LM3080	± 18V
LM3080A	± 22V

Power Dissipation 250 mW

Differential Input Voltage ± 5V

Amplifier Bias Current ( $I_{ABC}$ ) 2 mA

DC Input Voltage +  $V_S$  to  $-V_S$

Output Short Circuit Duration Indefinite

Operating Temperature Range  
LM3080N or LM3080AN 0°C to +70°C

Storage Temperature Range -65°C to +150°C

Lead Temperature (Soldering, 10 sec.) 260°C

## Electrical Characteristics (Note 1)

Parameter	Conditions	LM3080			LM3080A			Units
		Min	Typ	Max	Min	Typ	Max	
Input Offset Voltage	Over Specified Temperature Range $I_{ABC} = 5 \mu A$		0.4	5		0.4	2	mV
				6			5	mV
			0.3			0.3	2	mV
Input Offset Voltage Change	$5 \mu A \leq I_{ABC} \leq 500 \mu A$		0.1			0.1	3	mV
Input Offset Current			0.1	0.6		0.1	0.6	$\mu A$
Input Bias Current	Over Specified Temperature Range		0.4	5		0.4	5	$\mu A$
			1	7		1	8	$\mu A$
Forward Transconductance ( $g_m$ )	Over Specified Temperature Range	6700	9600	13000	7700	9600	12000	$\mu mho$
		5400			4000			$\mu mho$
Peak Output Current	$R_L = 0, I_{ABC} = 5 \mu A$		5		3	5	7	$\mu A$
	$R_L = 0$	350	500	650	350	500	650	$\mu A$
	$R_L = 0$ Over Specified Temperature Range	300			300			$\mu A$
Peak Output Voltage	$R_L = \infty, 5 \mu A \leq I_{ABC} \leq 500 \mu A$ $R_L = \infty, 5 \mu A \leq I_{ABC} \leq 500 \mu A$	+12	+14.2		+12	+14.2		V
		-12	-14.4		-12	-14.4		V
Amplifier Supply Current			1.1			1.1		mA
Input Offset Voltage Sensitivity	$\Delta V_{OFFSET}/\Delta V +$ $\Delta V_{OFFSET}/\Delta V -$		20	150		20	150	$\mu V/V$
			20	150		20	150	$\mu V/V$
Common Mode Rejection Ratio		80	110		80	110		dB
Common Mode Range		± 12	± 14		± 12	± 14		V
Input Resistance		10	26		10	26		k $\Omega$
Magnitude of Leakage Current	$I_{ABC} = 0$		0.2	100		0.2	5	nA
Differential Input Current	$I_{ABC} = 0, Input = \pm 4V$		0.02	100		0.02	5	nA
Open Loop Bandwidth			2			2		MHz
Slew Rate	Unity Gain Compensated		50			50		V/ $\mu s$

**Note 1:** These specifications apply for  $V_S = \pm 15V$  and  $T_A = 25^\circ C$ , amplifier bias current ( $I_{ABC}$ ) = 500  $\mu A$ , unless otherwise specified.

**Note 2:** Selection to supply voltage above  $\pm 22V$ , contact the factory.

# Typical Performance Characteristics

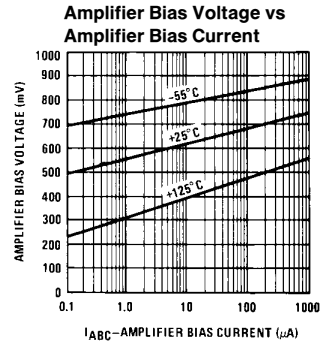
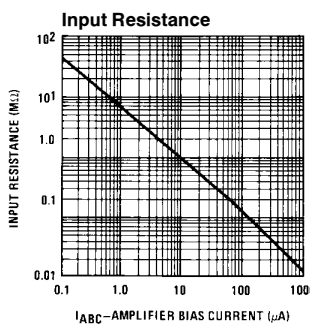
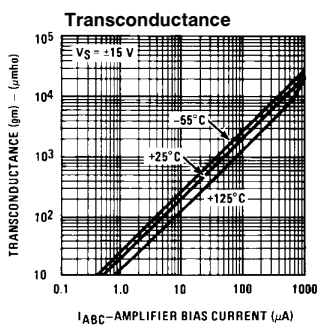
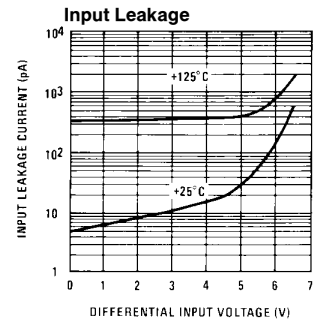
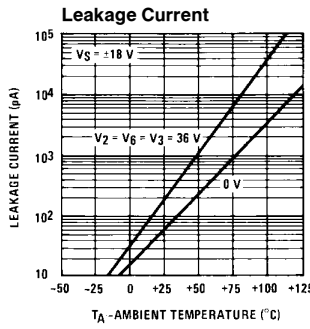
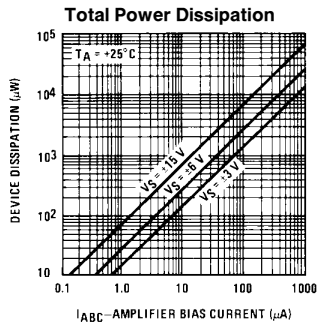
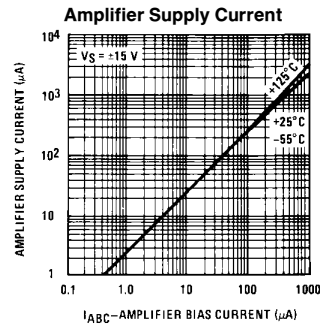
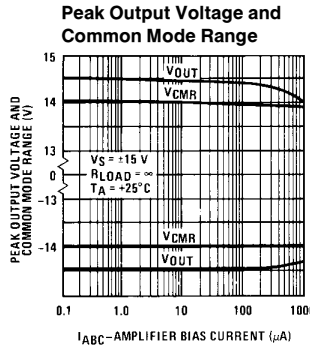
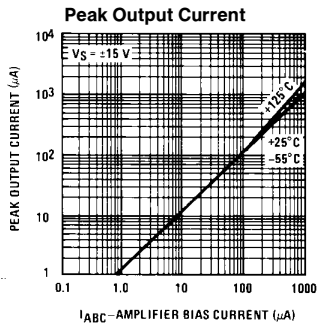
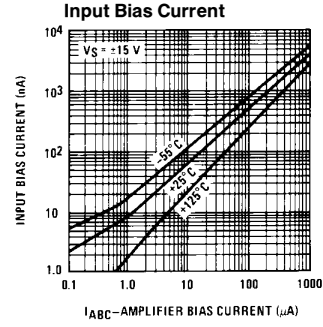
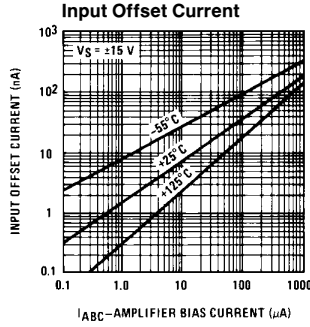
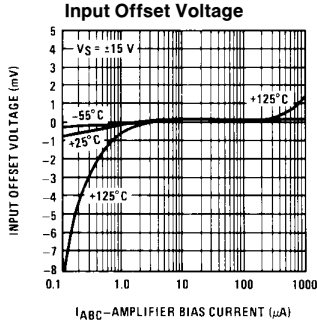

TL/H/7148-3

# Typical Performance Characteristics (Continued)

**Input and Output Capacitance**

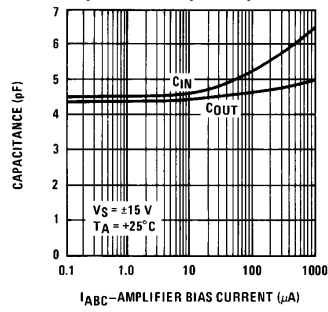

TL/H/7148-4

**Output Resistance**

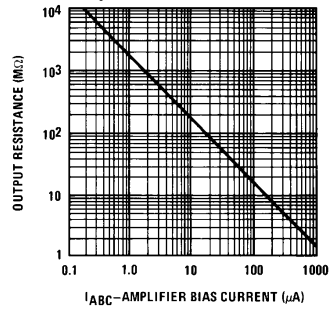

TL/H/7148-5

**Leakage Current Test Circuit**

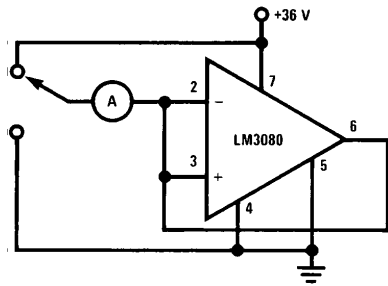

TL/H/7148-6

**Unity Gain Follower**

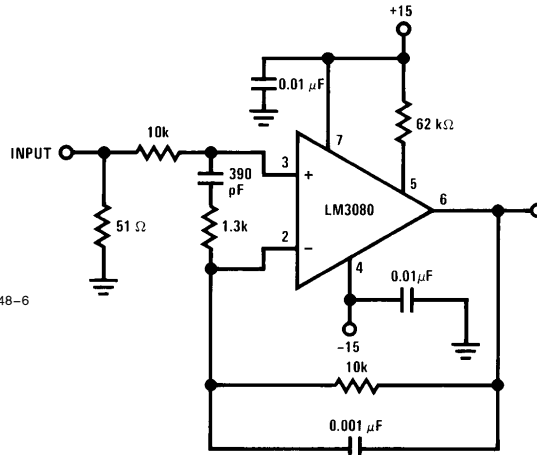

TL/H/7148-8

**Differential Input Current Test Circuit**

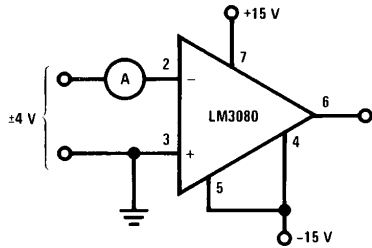

TL/H/7148-7

**Physical Dimensions** inches (millimeters)

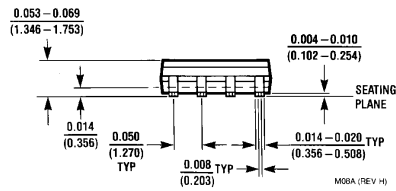
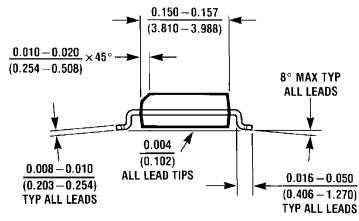
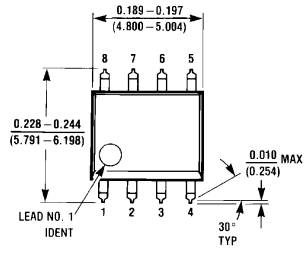

**Molded Package SO (M)  
Order Number LM3080M  
NS Package Number M08A**

M08A (REV. H)

**Physical Dimensions** inches (millimeters) (Continued)

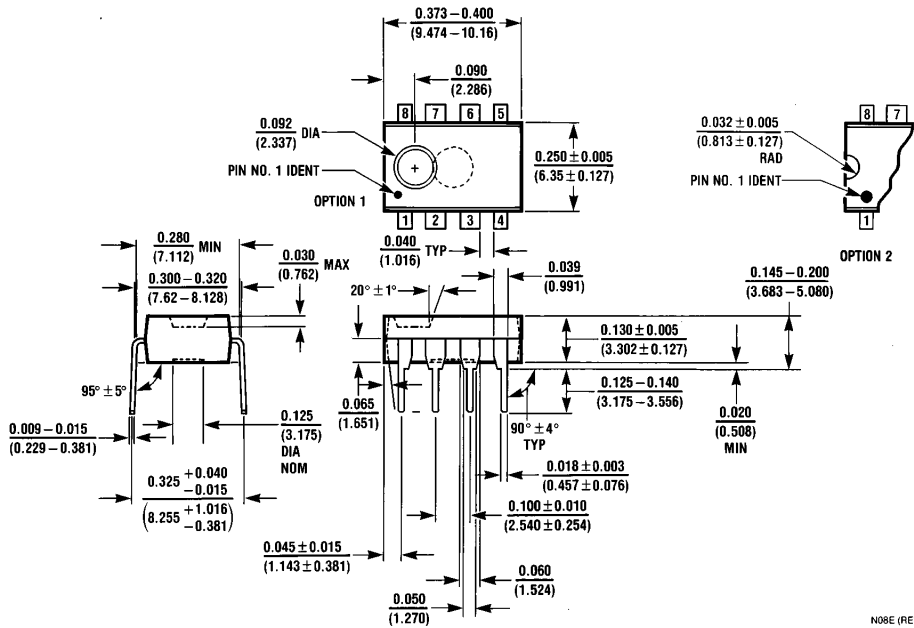

**Molded Dual-In-Line Package (N)**  
**Order Number LM3080AN or LM3080N**  
**NS Package Number N08E**

N08E (REV F)

**LIFE SUPPORT POLICY**

NATIONAL'S PRODUCTS ARE NOT AUTHORIZED FOR USE AS CRITICAL COMPONENTS IN LIFE SUPPORT DEVICES OR SYSTEMS WITHOUT THE EXPRESS WRITTEN APPROVAL OF THE PRESIDENT OF NATIONAL SEMICONDUCTOR CORPORATION. As used herein:

1. Life support devices or systems are devices or systems which, (a) are intended for surgical implant into the body, or (b) support or sustain life, and whose failure to perform, when properly used in accordance with instructions for use provided in the labeling, can be reasonably expected to result in a significant injury to the user.
2. A critical component is any component of a life support device or system whose failure to perform can be reasonably expected to cause the failure of the life support device or system, or to affect its safety or effectiveness.



**National Semiconductor Corporation**  
 1111 West Bardin Road  
 Arlington, TX 76017  
 Tel: 1(800) 272-9959  
 Fax: 1(800) 737-7018

**National Semiconductor Europe**  
 Fax: (+49) 0-180-530 85 86  
 Email: cnjwge@tevm2.nsc.com  
 Deutsch Tel: (+49) 0-180-530 85 85  
 English Tel: (+49) 0-180-532 78 32  
 Français Tel: (+49) 0-180-532 93 58  
 Italiano Tel: (+49) 0-180-534 16 80

**National Semiconductor Hong Kong Ltd.**  
 19th Floor, Straight Block,  
 Ocean Centre, 5 Canton Rd.  
 Tsimshatsui, Kowloon  
 Hong Kong  
 Tel: (852) 2737-1600  
 Fax: (852) 2736-9960

**National Semiconductor Japan Ltd.**  
 Tel: 81-043-299-2309  
 Fax: 81-043-299-2408

National does not assume any responsibility for use of any circuitry described, no circuit patent licenses are implied and National reserves the right at any time without notice to change said circuitry and specifications.