

Distributed by:

JAMECO[®]
ELECTRONICS

www.Jameco.com ♦ 1-800-831-4242

The content and copyrights of the attached
material are the property of its owner.

Jameco Part Number 1212443

74LVX244

Low Voltage Octal Buffer/Line Driver with 3-STATE Outputs

General Description

The LVX244 is an octal non-inverting buffer and line driver designed to be employed as a memory address driver, clock driver and bus oriented transmitter or receiver which provides improved PC board density. The inputs tolerate up to 7V allowing interface of 5V systems to 3V systems.

Features

- Input voltage translation from 5V to 3V
- Ideal for low power/low noise 3.3V applications
- Guaranteed simultaneous switching noise level and dynamic threshold performance

Ordering Code:

Order Number	Package Number	Package Description
74LVX244M	M20B	20-Lead Small Outline Integrated Circuit (SOIC), JEDEC MS-013, 0.300" Wide
74LVX244SJ	M20D	Pb-Free 20-Lead Small Outline Package (SOP), EIAJ TYPE II, 5.3mm Wide
74LVX244MTC	MTC20	20-Lead Thin Shrink Small Outline Package (TSSOP), JEDEC MO-153, 4.4mm Wide

Devices also available in Tape and Reel. Specify by appending suffix letter "X" to the ordering code.
Pb-Free package per JEDEC J-STD-020B.

Logic Symbol

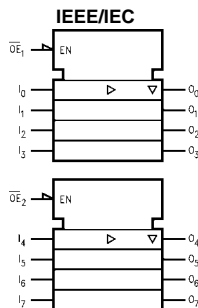

Connection Diagram

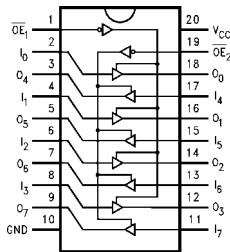

Pin Descriptions

Pin Names	Description
$\overline{OE}_1, \overline{OE}_2$	3-STATE Output Enable Inputs
I_0-I_7	Inputs
O_0-O_7	Outputs

Truth Tables

Inputs		Outputs
\overline{OE}_1	I_n	(Pins 12, 14, 16, 18)
L	L	L
L	H	H
H	X	Z

Inputs		Outputs
\overline{OE}_2	I_n	(Pins 3, 5, 7, 9)
L	L	L
L	H	H
H	X	Z

H = HIGH Voltage Level
X = Immaterial
L = LOW Voltage Level
Z = High Impedance

Absolute Maximum Ratings (Note 1)

Supply Voltage (V_{CC})	-0.5V to +7.0V
DC Input Diode Current (I_{IK})	
$V_I = -0.5V$	-20 mA
DC Input Voltage (V_I)	-0.5V to 7V
DC Output Diode Current (I_{OK})	
$V_O = -0.5V$	-20 mA
$V_O = V_{CC} + 0.5V$	+20 mA
DC Output Voltage (V_O)	-0.5V to $V_{CC} + 0.5V$
DC Output Source or Sink Current (I_O)	± 25 mA
DC V_{CC} or Ground Current (I_{CC} or I_{GND})	± 75 mA
Storage Temperature (T_{STG})	-65°C to +150°C
Power Dissipation	180 mW

Recommended Operating Conditions (Note 2)

Supply Voltage (V_{CC})	2.0V to 3.6V
Input Voltage (V_I)	0V to 5.5V
Output Voltage (V_O)	0V to V_{CC}
Operating Temperature (T_A)	-40°C to +85°C
Input Rise and Fall Time ($\Delta t/\Delta V$)	0 ns/V to 100 ns/V

Note 1: The "Absolute Maximum Ratings" are those values beyond which the safety of the device cannot be guaranteed. The device should not be operated at these limits. The parametric values defined in the Electrical Characteristics tables are not guaranteed at the absolute maximum ratings. The "Recommended Operating Conditions" table will define the conditions for actual device operation.

Note 2: Unused inputs must be held HIGH or LOW. They may not float.

DC Electrical Characteristics

Symbol	Parameter	V_{CC}	$T_A = +25^\circ\text{C}$			$T_A = -40^\circ\text{C to } +85^\circ\text{C}$		Units	Conditions
			Min	Typ	Max	Min	Max		
V_{IH}	HIGH Level Input Voltage	2.0	1.5			1.5		V	
		3.0	2.0			2.0			
		3.6	2.4			2.4			
V_{IL}	LOW Level Input Voltage	2.0			0.5		0.5	V	
		3.0			0.8		0.8		
		3.6			0.8		0.8		
V_{OH}	HIGH Level Output Voltage	2.0	1.9	2.0		1.9		V	$V_{IN} = V_{IH}$ or V_{IL} $I_{OH} = -50 \mu\text{A}$ $I_{OH} = -50 \mu\text{A}$ $I_{OH} = -4 \text{mA}$
		3.0	2.9	3.0		2.9			
		3.0	2.58			2.48			
V_{OL}	LOW Level Output Voltage	2.0		0.0	0.1		0.1	V	$V_{IN} = V_{IH}$ or V_{IL} $I_{OL} = 50 \mu\text{A}$ $I_{OL} = 50 \mu\text{A}$ $I_{OL} = 4 \text{mA}$
		3.0		0.0	0.1		0.1		
		3.0			0.36		0.44		
I_{OZ}	3-STATE Output Off-State Current	3.6			± 0.25		± 2.5	μA	$V_{IN} = V_{IH}$ or V_{IL} $V_{OUT} = V_{CC}$ or GND
I_{IN}	Input Leakage Current	3.6			± 0.1		± 1.0	μA	$V_{IN} = 5.5V$ or GND
I_{CC}	Quiescent Supply Current	3.6			4.0		40.0	μA	$V_{IN} = V_{CC}$ or GND

Noise Characteristics (Note 3)

Symbol	Parameter	V_{CC} (V)	$T_A = 25^\circ\text{C}$		Units	C_L (pF)
			Typ	Limit		
V_{OLP}	Quiet Output Maximum Dynamic V_{OL}	3.3	0.5	0.8	V	50
V_{OLV}	Quiet Output Minimum Dynamic V_{OL}	3.3	-0.5	-0.8	V	50
V_{IHD}	Minimum HIGH Level Dynamic Input Voltage	3.3		2.0	V	50
V_{ILD}	Maximum LOW Level Dynamic Input Voltage	3.3		0.8	V	50

Note 3: Input $t_r = t_f = 3 \text{ ns}$

AC Electrical Characteristics									
Symbol	Parameter	V _{CC} (V)	T _A = +25°C			T _A = -40°C to +85°C		Units	Conditions
			Min	Typ	Max	Min	Max		
t _{PLH}	Propagation Delay Time	2.7		6.1	11.4	1.0	13.5	ns	C _L = 15 pF
t _{PHL}				8.6	14.9	1.0	17.0		C _L = 50 pF
		3.3 ± 0.3		4.7	7.1	1.0	8.5		C _L = 15 pF
				7.2	10.6	1.0	12.0		C _L = 50 pF
t _{PZL}	3-STATE Output Enable Time	2.7		7.1	13.8	1.0	16.5	ns	C _L = 15 pF, R _L = 1 kΩ
t _{PZH}				9.6	17.3	1.0	20.0		C _L = 50 pF, R _L = 1 kΩ
		3.3 ± 0.3		5.5	8.8	1.0	10.5		C _L = 15 pF, R _L = 1 kΩ
				8.0	12.3	1.0	14.0		C _L = 50 pF, R _L = 1 kΩ
t _{PLZ}	3-STATE Output Disable Time	2.7		11.6	16.0	1.0	19.0	ns	C _L = 50 pF, R _L = 1 kΩ
t _{PHZ}		3.3 ± 0.3		9.7	11.4	1.0	13.0		
t _{OSLH}	Output to Output	2.7			1.5		1.5	ns	C _L = 50 pF
t _{OSHL}	Skew (Note 4)	3.3			1.5		1.5		

Note 4: Parameter guaranteed by design. t_{OSLH} = |t_{PLHm} - t_{PLHn}|, t_{OSHL} = |t_{PHLm} - t_{PHLn}|

Capacitance

Symbol	Parameter	T _A = +25°C			T _A = -40°C to +85°C		Units
		Min	Typ	Max	Min	Max	
C _{IN}	Input Capacitance		4	10		10	pF
C _{OUT}	Output Capacitance		6				pF
C _{PD}	Power Dissipation Capacitance (Note 5)		19				pF

Note 5: C_{PD} is defined as the value of the internal equivalent capacitance which is calculated from the operating current consumption without load.

$$\text{Average operating current can be obtained by the equation: } I_{CC(\text{opr.})} = \frac{C_{PD} \times V_{CC} \times f_{IN} + I_{CC}}{8 \text{ (per bit)}}$$

Physical Dimensions inches (millimeters) unless otherwise noted

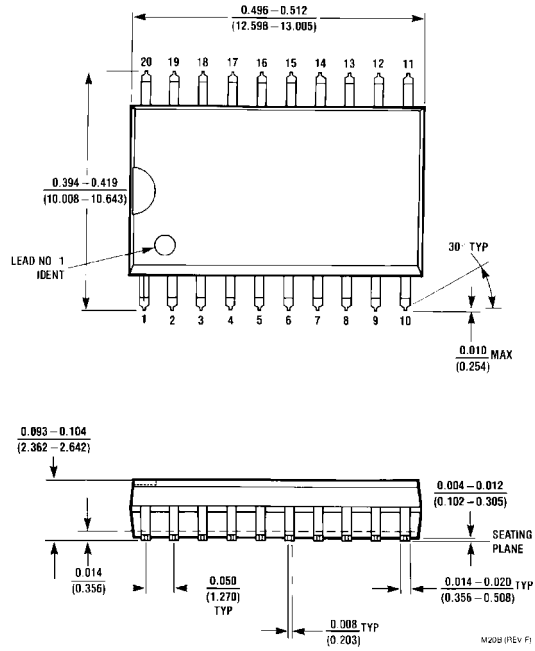

**20-Lead Small Outline Integrated Circuit (SOIC), JEDEC MS-013, 0.300" Wide
Package Number M20B**

Physical Dimensions inches (millimeters) unless otherwise noted (Continued)

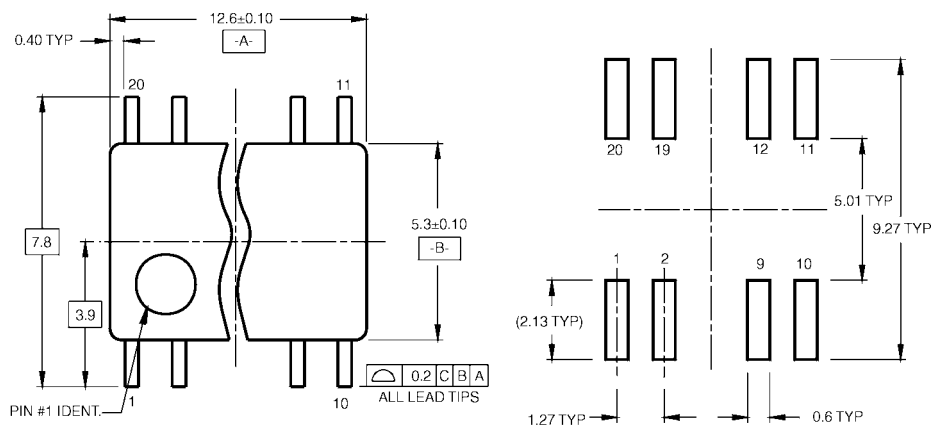

LAND PATTERN RECOMMENDATION



DIMENSIONS ARE IN MILLIMETERS

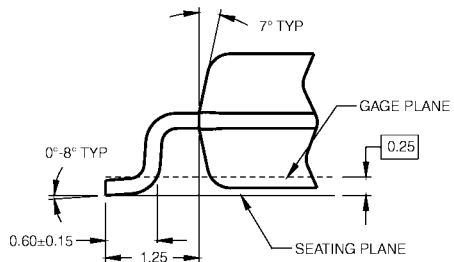
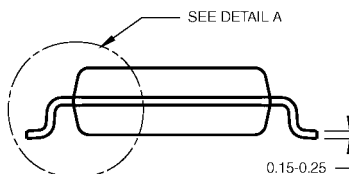

DETAIL A

- NOTES:
- A. CONFORMS TO EIAJ EDR-7320 REGISTRATION, ESTABLISHED IN DECEMBER, 1998.
 - B. DIMENSIONS ARE IN MILLIMETERS.
 - C. DIMENSIONS ARE EXCLUSIVE OF BURRS, MOLD FLASH, AND TIE BAR EXTRUSIONS.

M20DRevB1

**Pb-Free 20-Lead Small Outline Package (SOP), EIAJ TYPE II, 5.3mm Wide
Package Number M20D**

Physical Dimensions inches (millimeters) unless otherwise noted (Continued)

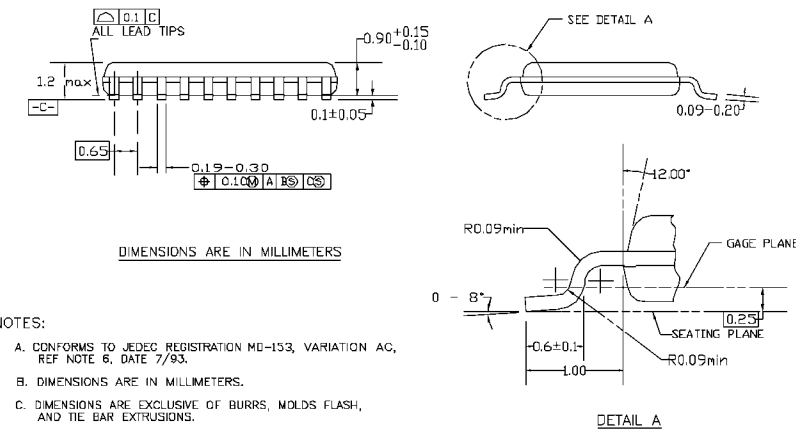
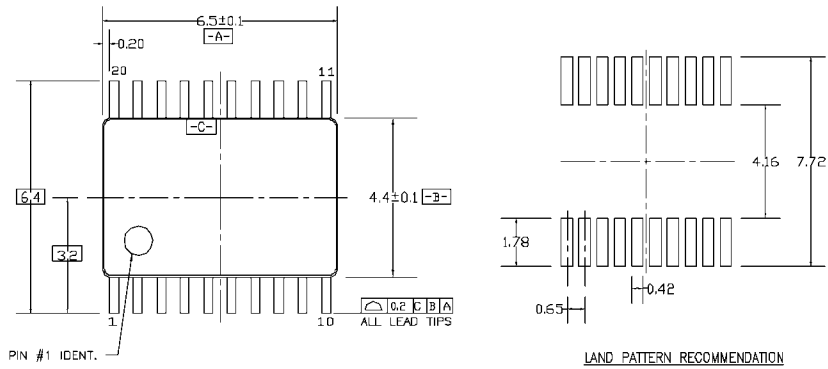

DIMENSIONS ARE IN MILLIMETERS

NOTES:

- A. CONFORMS TO JEDEC REGISTRATION MO-153, VARIATION AC, REF NOTE 6, DATE 7/93.
- B. DIMENSIONS ARE IN MILLIMETERS.
- C. DIMENSIONS ARE EXCLUSIVE OF BURRS, MOLDS FLASH, AND TIE BAR EXTRUSIONS.
- D. DIMENSIONS AND TOLERANCES PER ANSI Y14.5M, 1982.

MTC20REV D1

20-Lead Thin Shrink Small Outline Package (TSSOP), JEDEC MO-153, 4.4mm Wide Package Number MTC20

Fairchild does not assume any responsibility for use of any circuitry described, no circuit patent licenses are implied and Fairchild reserves the right at any time without notice to change said circuitry and specifications.

LIFE SUPPORT POLICY

FAIRCHILD'S PRODUCTS ARE NOT AUTHORIZED FOR USE AS CRITICAL COMPONENTS IN LIFE SUPPORT DEVICES OR SYSTEMS WITHOUT THE EXPRESS WRITTEN APPROVAL OF THE PRESIDENT OF FAIRCHILD SEMICONDUCTOR CORPORATION. As used herein:

1. Life support devices or systems are devices or systems which, (a) are intended for surgical implant into the body, or (b) support or sustain life, and (c) whose failure to perform when properly used in accordance with instructions for use provided in the labeling, can be reasonably expected to result in a significant injury to the user.
2. A critical component in any component of a life support device or system whose failure to perform can be reasonably expected to cause the failure of the life support device or system, or to affect its safety or effectiveness.

www.fairchildsemi.com