

Distributed by:



[www.Jameco.com](http://www.Jameco.com) ♦ 1-800-831-4242

The content and copyrights of the attached material are the property of its owner.

# 2<sup>12</sup> Series Encoders

## Features

- Operating voltage:  
2.4V-5V for the HT12A/B/C  
2.4V-12V for the HT12E
- Low power, high noise immunity CMOS technology
- Low stand-by current
- Minimum transmission word:  
Four words for the HT12E  
One word for the HT12A/B/C
- Built-in oscillator, needs only 5% resistor
- HT12A/B/C with 38KHz carrier for Infra-Red transmission media
- Data code polarity:  
HT12A/C/E: Positive polarity  
HT12B: Negative polarity
- Minimal external components

## Applications

- Burglar alarm system
- Smoke and fire alarm system
- Garage door controller
- Car door controller
- Car alarm system
- Security system
- Cordless telephone
- Other remote control system

## General Description

The 2<sup>12</sup> series of encoders are CMOS LSIs for Remote Control System applications. They are capable of encoding 12 bits of information consisting of N address bits and 12-N data bits. Each address/data input can be set to one of two logic states. The programmed address/data information will be transmitted together with

header bits via an RF or Infra-Red transmission medium upon receipt of a trigger signal. The capability to select a  $\overline{TE}$  trigger on the HT12E or a DATA trigger on the HT12A/B/C further enhance application flexibility. The HT12A/B/C provides a 38KHz carrier for Infra-Red systems.

## Selection Table

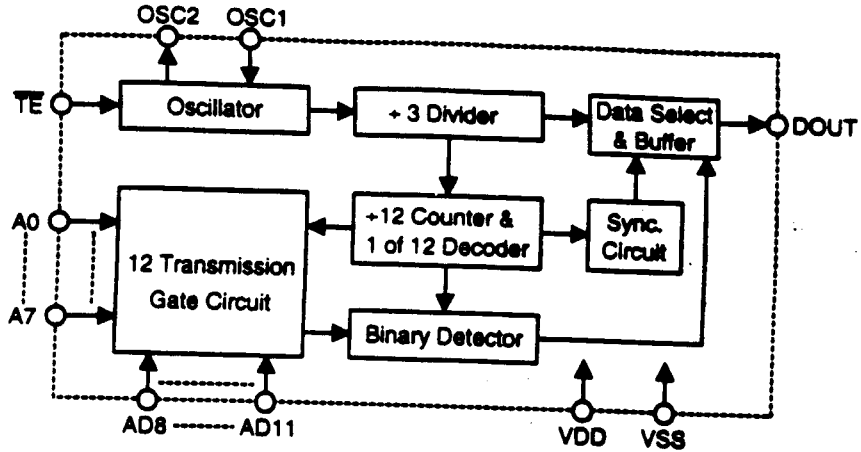
Function Item	Address No.	Address/ Data No.	Data No.	Oscillator	Trigger	Package	Carrier Output	Negative Polarity
HT12A	8	0	4	455K Hz resonator	D8-D11	18 DIP/ 20 SOP	38K Hz	No
HT12B	8	0	4	455K Hz resonator	D8-D11	18 DIP/ 20 SOP	38K Hz	Yes
HT12C	0	0	10	455K Hz resonator	D2-D11	16 DIP/ 16 SOP	38K Hz	No
	2					18 DIP		
HT12E	8	4	0	RC oscillator	$\overline{TE}$	18 DIP/ 20 SOP	No	No

Note: Address/Data represents pins that can be address or data according the decoder requirement.

**Block Diagram**

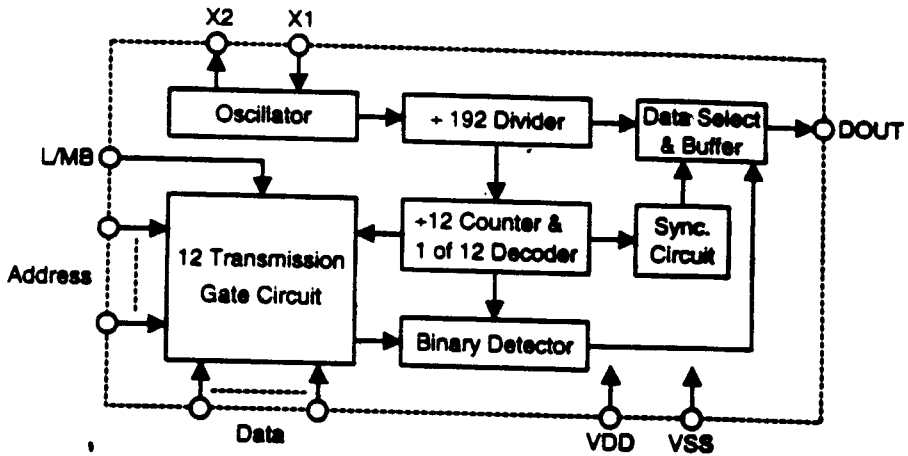
$\overline{TE}$  trigger

HT12E



**DATA trigger**

HT12A/B/C



**Note:** Address Data pins are available in various combinations, refer to address/data table.

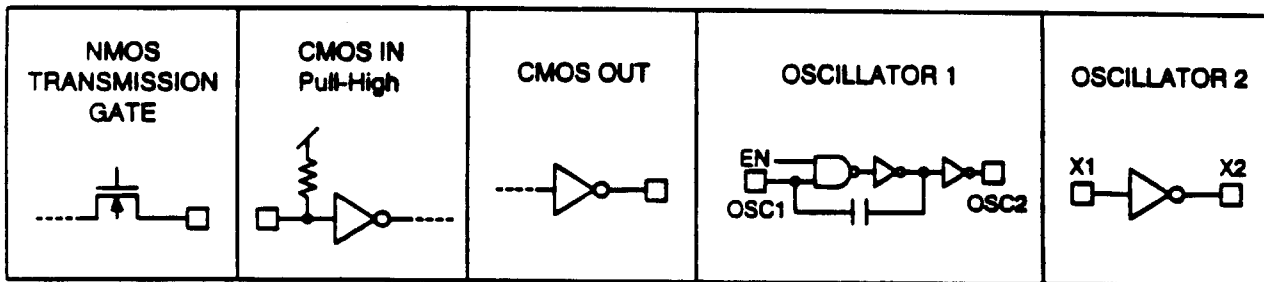
**Pin Description**

Pin Name	I/O	Internal Connection	Description
A0~A7	I	CMOS IN Pull-High (HT12A/B/C) NMOS TRANSMISSION GATE (HT12E)	Input pin for address A0~A7 setting. Can be externally set to VDD or VSS.
AD8~AD11	I	NMOS TRANSMISSION GATE	Input pin for address/data AD8~AD11 setting. Can be externally set to VDD or VSS (HT12E only).
D2~D11	I	CMOS IN Pull-High	Input pin for data D2~D11 setting and transmission enable. Active low. Can be externally set to VSS or open. See note.
DOUT	O	CMOS OUT	Encoder data serial transmission output.
LMB	I	CMOS IN Pull-High	Latch/Momentary transmission format select pin. Latch: floating or VDD Momentary: VSS
$\overline{TE}$	I	CMOS IN Pull-High	Transmission enable, active low. See note.
OSC1	I	OSCILLATOR 1	Oscillator input pin.
OSC2	O	OSCILLATOR 1	Oscillator output pin.
X1	I	OSCILLATOR 2	455KHz resonator oscillator input.
X2	O	OSCILLATOR 2	455KHz resonator oscillator output.
VSS	I	—	Negative power supply (GND).
VDD	I	—	Positive power supply.

Note: D2~D11 are data input and transmission enable pins for the HT12A/B/C.

$\overline{TE}$  is the transmission enable pin for the HT12E.

**Approximate internal connection circuits**



**Absolute Maximum Ratings**

Supply Voltage (HT12A/B/C).....-0.3V to 5.5V  
 Supply Voltage (HT12E).....-0.3V to 13V  
 Input Voltage.....V<sub>SS</sub>-0.3 to V<sub>DD</sub>+0.3V

Storage Temperature.....-50°C to 125°C  
 Operating Temperature.....-20°C to 75°C

**Electrical Characteristics**
**HT12A/B/C**

(Ta=25°C)

Symbol	Parameter	Test Condition		Min.	Typ.	Max.	Unit
		V <sub>DD</sub>	Condition				
V <sub>DD</sub>	Operating Voltage	—	—	2.4	3	5	V
I <sub>STB</sub>	Stand-by Current	3V	Oscillator stop	—	0.1	1	μA
		5V		—	0.1	1	μA
I <sub>DD</sub>	Operating Current	3V	No Load. F <sub>OSC</sub> =455KHz	—	200	400	μA
		5V		—	400	800	μA
I <sub>DOUT</sub>	Output Drive Current	5V	V <sub>OH</sub> =0.9V <sub>DD</sub> (Source)	-1	-1.6	—	mA
			V <sub>OL</sub> =0.1V <sub>DD</sub> (Sink)	2	3.2	—	mA
V <sub>IH</sub>	"H" Input Voltage	—	—	0.8V <sub>DD</sub>	—	V <sub>DD</sub>	V
V <sub>IL</sub>	"L" Input Voltage	—	—	0	—	0.2V <sub>DD</sub>	V
R <sub>DATA</sub>	D2~D11 Pull High Resistance	5V	V <sub>DATA</sub> =0V	—	150	300	KΩ

**HT12E**

(Ta=25°C)

Symbol	Parameter	Test Condition		Min.	Typ.	Max.	Unit
		V <sub>DD</sub>	Condition				
V <sub>DD</sub>	Operating Voltage	—	—	2.4	5	12	V
I <sub>STB</sub>	Stand-by Current	3V	Oscillator stop	—	0.1	1	μA
		12V		—	2	4	μA
I <sub>DD</sub>	Operating Current	3V	No Load. F <sub>OSC</sub> =3KHz	—	40	80	μA
		12V		—	150	300	μA
I <sub>DOUT</sub>	Output Drive Current	5V	V <sub>OH</sub> =0.9V <sub>DD</sub> (Source)	-1	-1.6	—	mA
			V <sub>OL</sub> =0.1V <sub>DD</sub> (Sink)	1	1.6	—	mA
V <sub>IH</sub>	"H" Input Voltage	—	—	0.8V <sub>DD</sub>	—	V <sub>DD</sub>	V
V <sub>IL</sub>	"L" Input Voltage	—	—	0	—	0.2V <sub>DD</sub>	V
F <sub>OSC</sub>	Oscillator Frequency	5V	R <sub>OSC</sub> =1.1MΩ	—	3	—	KHz
R <sub>TE</sub>	TE Pull High Resistance	5V	V <sub>TE</sub> =0V	—	1.5	3	MΩ

## Functional Description

### Operation

Upon receipt of a transmission enable ( $\overline{TE}$  for the HT12E or D2-D11 for the HT12A/B/C, active low), the encoder begins a 4 word transmission cycle. This cycle is repeated as long as the transmission enable ( $\overline{TE}$  or D2-D11) is held low. After the transmission enable returns high the encoder output completes it's final cycle and then stops as in Fig.1 for the HT12E and Fig.2,3 for the HT12A/B/C.

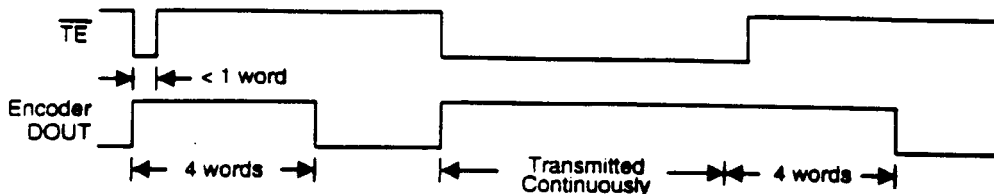


Fig.1 Transmission timing for the HT12E

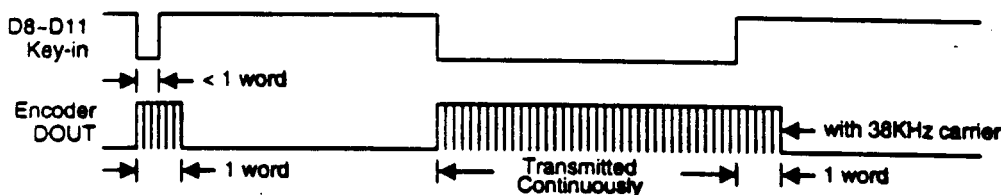


Fig.2 Transmission timing for the HT12A/B/C (LMB=Floating or VDD)

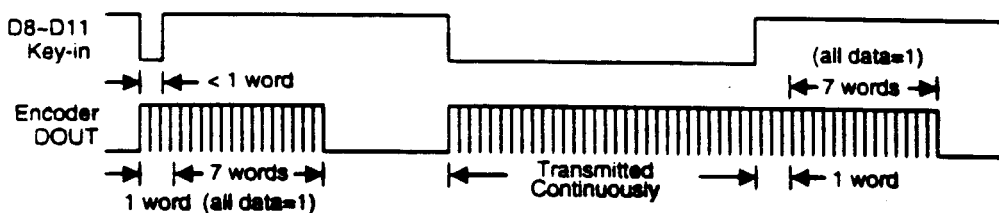


Fig.3 Transmission timing for the HT12A/B/C (LMB=VSS)

### Information word

The LMB is the Latch/Momentary selection pin. With LMB=1 the device is in the latch mode (for use with latch data decoders). When the transmission enable is removed during a transmission, the DOUT pin outputs a complete word and then stops. With LMB=0 the device is in the momentary mode (for use with latch data decoders). When the transmission enable is removed during a transmission, the DOUT now outputs a complete word and adds 7 words all of which have "1" data codes.

An information word is composed of 3 periods as in Fig.4.

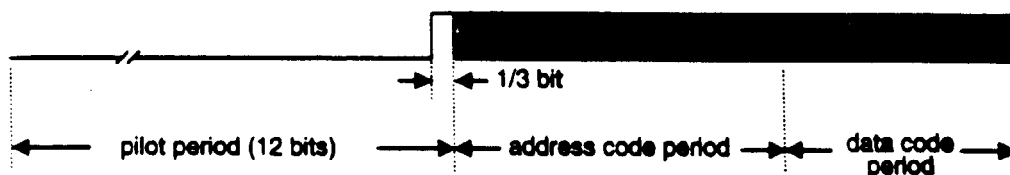
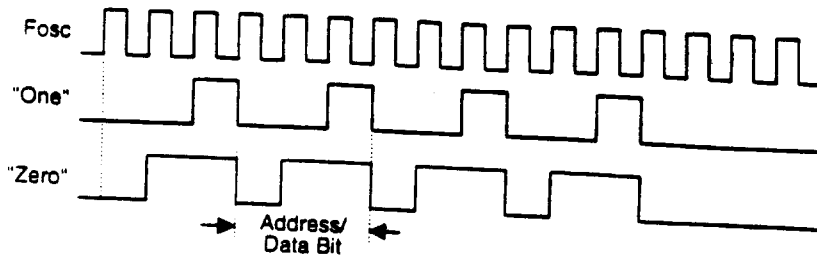


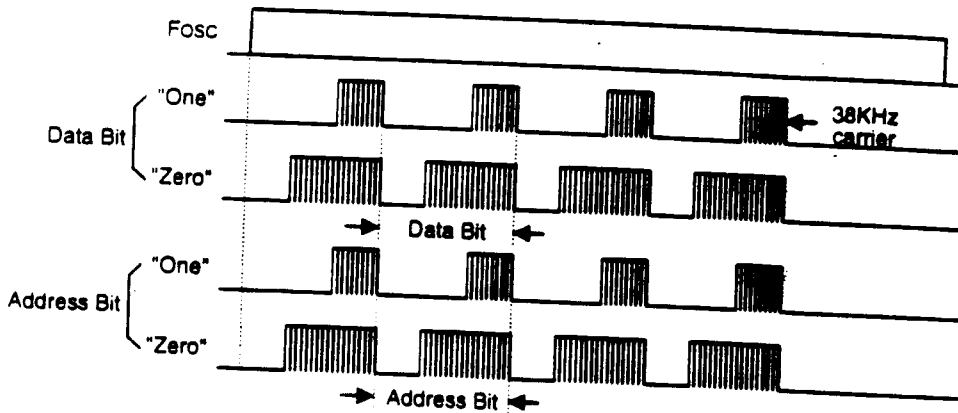
Fig.4 Composition of Information

**Address/data waveform**

Each programmable address/data pin can be externally set to one of the two following logic states as in Fig.5 (for the HT12E) and Fig.6,7 (for the HT12A/B/C):

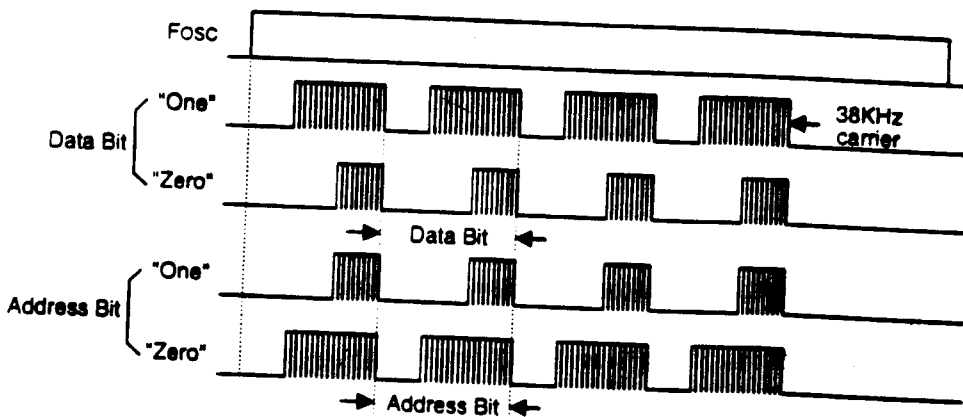


**Fig.5 Address/Data bit waveform for HT12E**



**Fig.6 Address/Data bit waveform for the HT12A/C**

The HT12B data code polarity is inverted:



**Fig.7 Address/Data bit waveform for the HT12B**

The address/data bits of the HT12A/B/C are transmitted with a 38KHz carrier for Infra-Red remote controller flexibility.

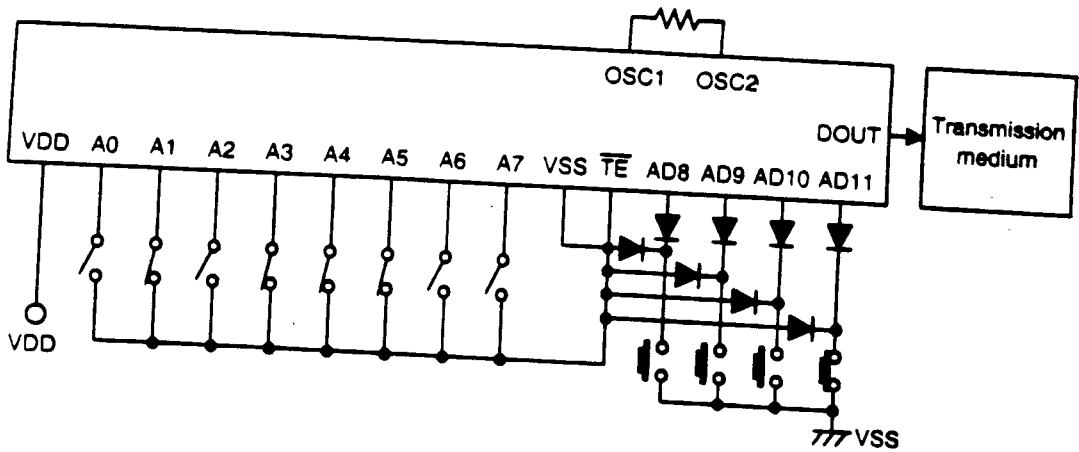
**Address/data programming (preset)**

The status of each address/data pin can be individually preset to a logic "high" or "low". When a transmission enable signal is applied, the encoder scans and transmits the status of the 12 bits address/data serially in the order A0 to AD11 for the HT12E encoder and A0 to D11 for the HT12A/B/C encoder.

During information transmission these bits will be transmitted with a preceding synchronization bit. When the trigger signal is not applied, the chip enters a stand-by mode and consumes a reduced current which is less than 1μA for a 5V supply voltage.

Usual applications preset the address pins with individual security codes by means of DIP switches or PCB wiring, while the data is selected by push button or electronic switches.

The following figure shows an application using the HT12E:



The transmitted information is shown as follows:

Pilot & Sync.	A0	A1	A2	A3	A4	A5	A6	A7	AD8	AD9	AD10	AD11
	1	0	1	0	0	0	1	1	1	1	1	0

**Address/Data sequence**

The following table provides the address/data sequence table for the various models of the 2<sup>12</sup> series encoders. The correct device should be selected according to individual address and data requirements.

HOLTEK Part No.	Address/Data Bits											
	0	1	2	3	4	5	6	7	8	9	10	11
HT12A	A0	A1	A2	A3	A4	A5	A6	A7	8	9	10	11
HT12B	A0	A1	A2	A3	A4	A5	A6	A7	D8	D9	D10	D11
HT12C	A0	A1	D2	D3	D4	D5	D6	D7	D8	D9	D10	D11
HT12E	A0	A1	A2	A3	A4	A5	A6	A7	AD8	AD9	AD10	AD11

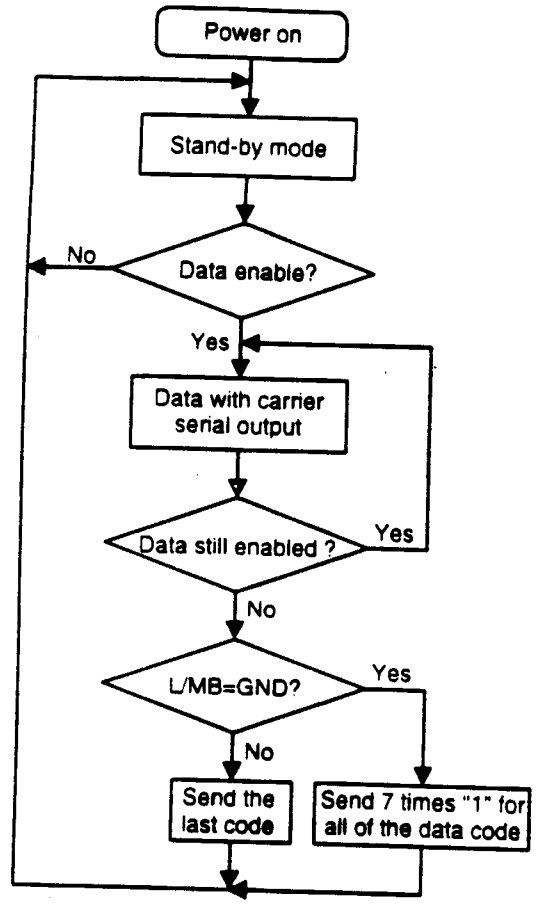


**Transmission enable**

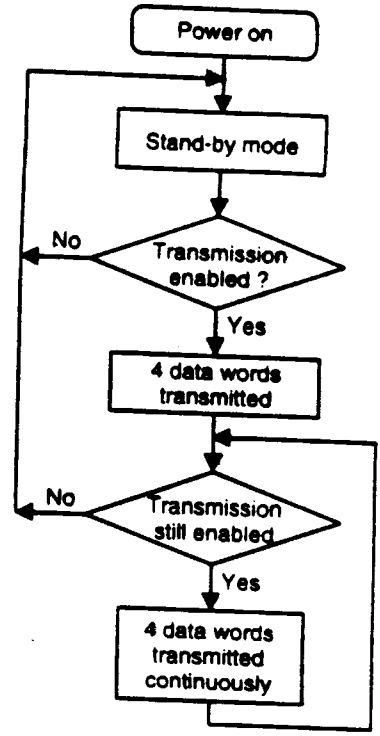
For the HT12E encoder, transmission is enabled by applying a low signal to the  $\overline{TE}$  pin. For the HT12A/B/C encoders transmission is enabled by applying a low signal to any one of the data pins D2-D11.

**Flowchart**

HT12A/B/C



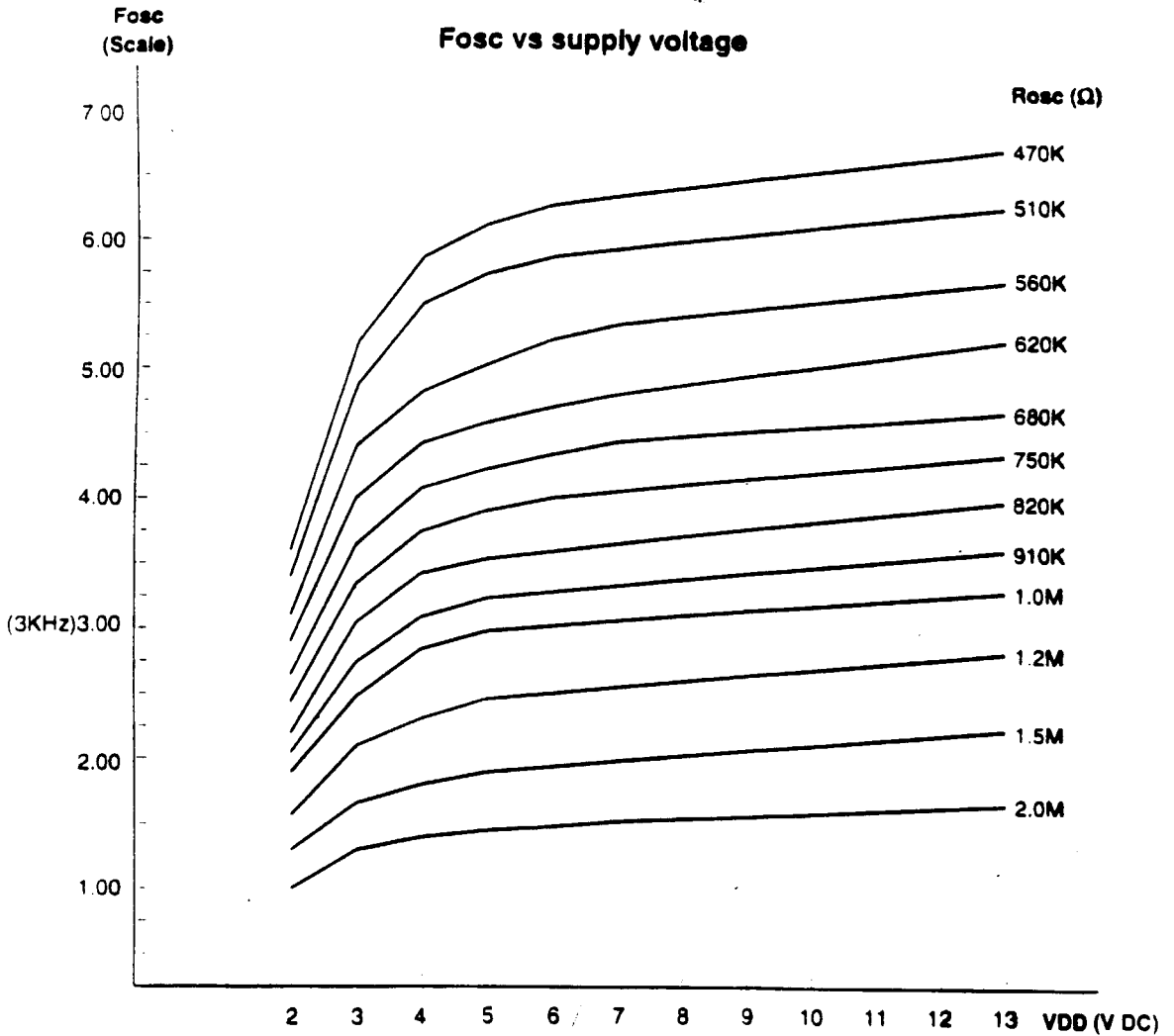
HT12E



Note: D2-D11 are transmission enables for the HT12A/B/C.

$\overline{TE}$  is the transmission enable for the HT12E.

**Oscillator frequency chart for the HT12E**

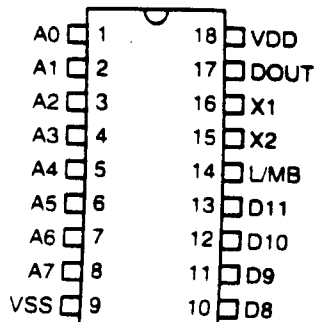


Recommended oscillator frequency is  $F_{OSCD} \text{ (Decoder)} \cong 50 F_{OSCE} \text{ (HT12E)}$

$$\cong \frac{1}{3} F_{OSCE} \text{ (HT12A/B/C)}$$

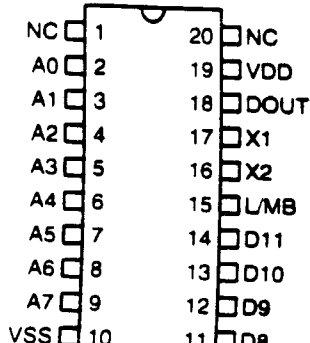
**Package Information**

**8 Address  
4 Data**



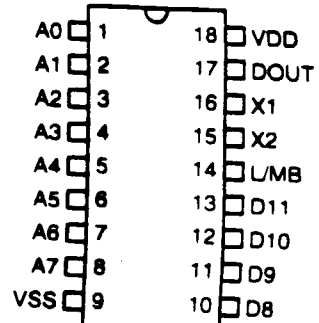
**HT12A  
-18 DIP**

**8 Address  
4 Data**



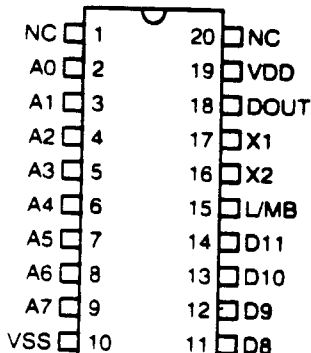
**HT12A  
-20 SOP**

**8 Address  
4 Data**



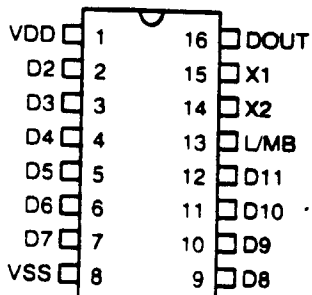
**HT12B  
-18 DIP**

**8 Address  
4 Data**



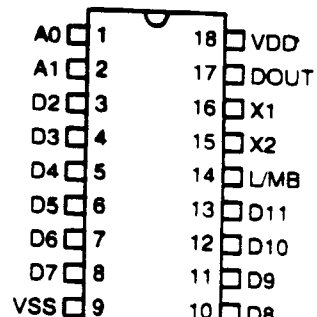
**HT12B  
-20 SOP**

**0 Address  
10 Data**



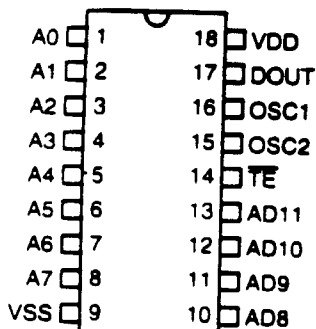
**HT12C  
-16 DIP/SOP**

**2 Address  
10 Data**



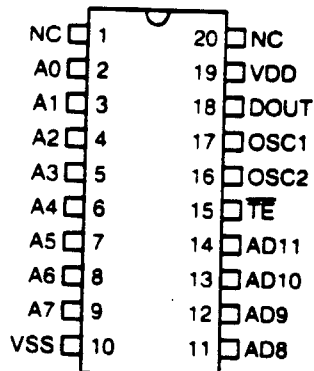
**HT12C  
-18 DIP**

**8 Address  
4 Address/Data**



**HT12E  
-18 DIP**

**8 Address  
4 Address/Data**



**HT12E  
-20 SOP**