

Distributed by:

**JAMECO**<sup>®</sup>  
ELECTRONICS

**www.Jameco.com ♦ 1-800-831-4242**

The content and copyrights of the attached  
material are the property of its owner.

Jameco Part Number 123932

# SPECIFICATION

CUSTOMER: JAMES

DATE: '08.03.25

MODEL NO: DDU140070

DESIGNED NO: Z7470

## 1. APPLICABLE SAFETY STANDARD :

PSE    UL 1310    UL 1950    C-CUL    GS    CE    商檢

## 2. GENERAL APPEARANCE :

- 2.1 THE GENERAL APPEARANCE OF THE AC/DC ADAPTOR SHALL BE WITHOUT DEFORMATION, CRACKS OR CORROSION.
- 2.2 THE SHAPE, DIMENSIONS AND MARKINGS OF THE AC/DC ADAPTOR SHALL BE AS SPECIFIED IN THE CONSTRUCTION DRAWING AND NAME PLATE.

## 3. CHARACTERISTICS :

- 3.1 PRIMARY RATED VOLTAGE & LINE FREQUENCY : 120 VAC 60 Hz
- 3.2 PRIMARY EXCITING CURRENT (Io) 90 mA MAX. AT INPUT 120 VAC 60 Hz.  
LOADING CURRENT (Ip) X mA MAX. AT INPUT X AC X Hz, LOAD X A.
- 3.3 NO - LOAD LOSS : X W MAX. AT INPUT X VAC X Hz.
- 3.4 SECONDARY RATED VOLTAGE AND CURRENT :

PRIMARY VOLTAGE	RATE VOLTAGE	TOLERANCE	RATED CURRENT	NO-LOAD VOLTAGE	REGULATION
120VAC 60Hz	14VDC	±5%	700mA-DC		

- 3.5 RIPPLE VOLTAGE : X mV(r.m.s) MAX. AT INPUT X VAC X Hz, LOAD X A.
- 3.6 DC RESISTANCE : PRIMARY: X Ω ± X % MEASURED AT 25 °C .
- 3.7 HI-POT TEST : AC 1240 V 50/60Hz FOR 1 MINUTES BETWEEN INPUT TO OUTPUT PLUG AND CASE NEED NORMAL PERFORMANCE , LEAKAGE CURRENT 1 mA.
- 3.8 INSULATION RESISTANCE : 500 VDC 100 MΩ MIN. BETWEEN INPUT TO OUTPUT PLUG AND CASE.
- 3.9 TEMPERATURE RISE :INPUT 120 VAC 60 Hz, OUTPUT LOAD 0.7 A FOR INPUT COIL 75 °C MAX (BY USE RESISTANCE METHOD) ON CASE SURFACE X °C MAX (BY USE THERMOMETER METHOD) AT 25°C AMBIENT.
- 3.10 HUMIDITY TEST : TEMP. 40±2 °C , 90-95 % R.H FOR 4 HOURS , AFTER AT MINUTES TAKEN OUT FROM OVEN . AND WIPED DRY. TEST 3.4 、 3.7 AND INSULATION TEST 10 MΩ MIN.

## 4. MECHANICAL PERFORMANCE :

- 4.1 STRAIN-RELIEF TEST : 10 LB FOR 60 SEC. IN ANY DIRECTION .
- 4.2 DROP TEST : UNIT IS TO BE DROPPED FROM 3 FEET HIGH ONTO A CONCRETE FLOOR COVERED WITH 1/8 INCH VINYL TILE 3 TIMES, THE UNIT SHOULD MEET THE ITEM 3.7 、 3.8.
- 4.3 BENDING RELIEF TEST : THE CORD AND S/R SHALL WITHSTAND WEIGHT OFF 200 g, IT SWINGS FROM LEFT TO RIGHT AT AN ANGLE OF 120 deg , 300 CYCLE TIMES NIN.
- 4.4 VIBRATION RESISTANCE : PRODUCT PACKAGED IN A INTENDED MANNER SHALL DEVELOP NO MECHANICAL OR ELECTRICAL FAILURE WHEN SUBJECTED TO A 1.5 mm PEAK TO PEAK AMPLITUDE , 10-50-10 Hz , VIBRATION IN EACH OF X , Y AND Z DIRECTIONS FOR 30 MINUTES .

## 5. TEMPERATURE RANGE:

- 5.1 USE TEMPERATURE EXTENT : 0 °C ~ +40 °C
- 5.2 STORAGE TEMPERATURE EXTENT : -25 °C ~ +55 °C

APPROVED BY \_\_\_\_\_ CHECKED BY \_\_\_\_\_ TESTED BY 李淑華

# ELECTRICAL DATA

CUSTOMER: JAMES

DATE: '08.03.25

MODEL NO: DDU140070

DESIGNED NO: Z7470

ITEM	SPEC.	SAMPLE									
		1	2	3	4	5	6	7	8	9	10
PRIMARY EXCITING CURRENT INPUT 120 V-AC 60 Hz	90 mA MAX.	43									
PRIMARY LOAD CURRENT INPUT 120 V-AC 60 Hz	mA	153									
SECONDARY #1 NO LOAD DC VOLTAGE		19.42									
SECONDARY #1 DC VOLTAGE LOAD 700mA-DC	14V±5%	14.15									
TEMP RISE AFTER 4 HRS WARM UP IN 25 °C AMBIENT	75 °C MAX.	OK									
HI-POT TEST	PRI. TO SEC. & CORE	AC 1240 V	OK								

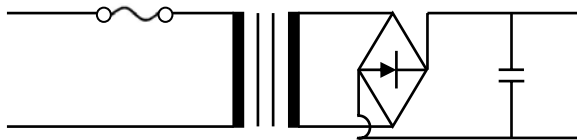

APPROVED BY \_\_\_\_\_ CHECKED BY \_\_\_\_\_ TESTED BY 李淑華

# 聯輝電機股份有限公司

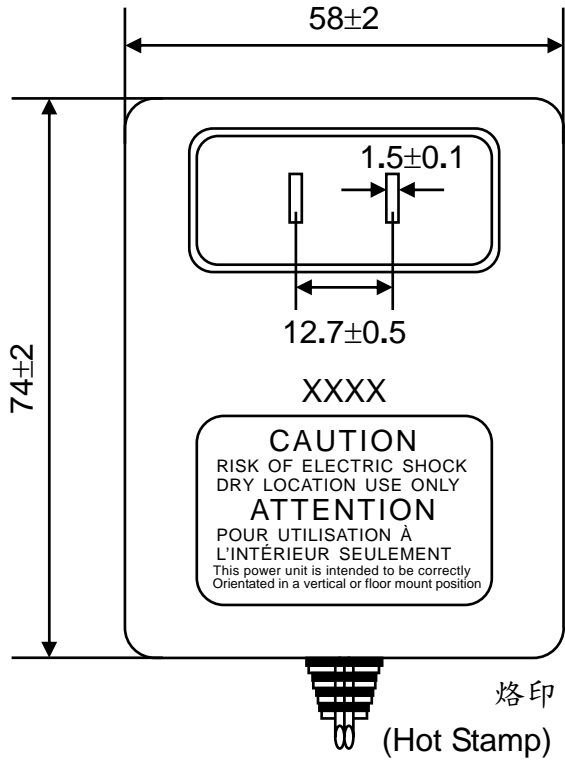

XXXX

月份 (Month)

年份 (Year)

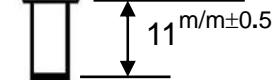
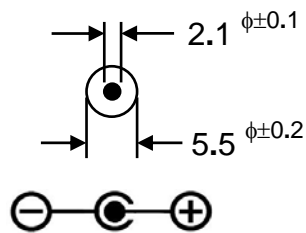
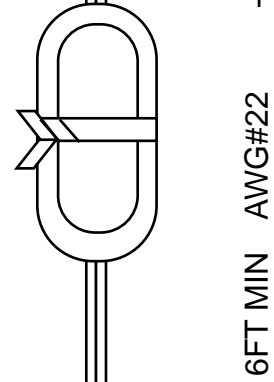
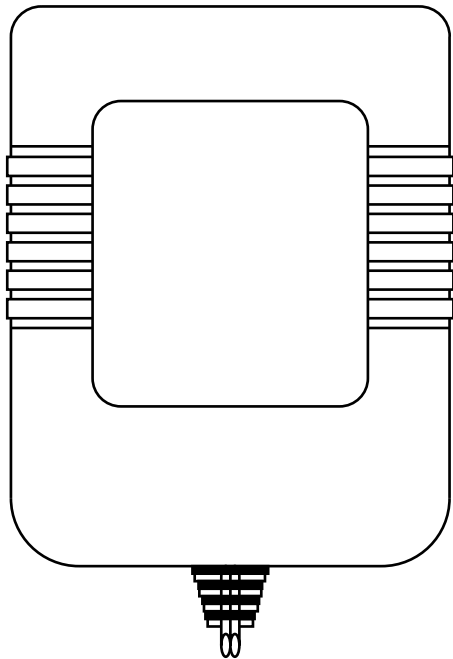
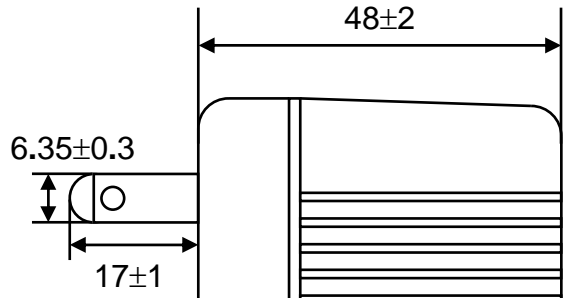

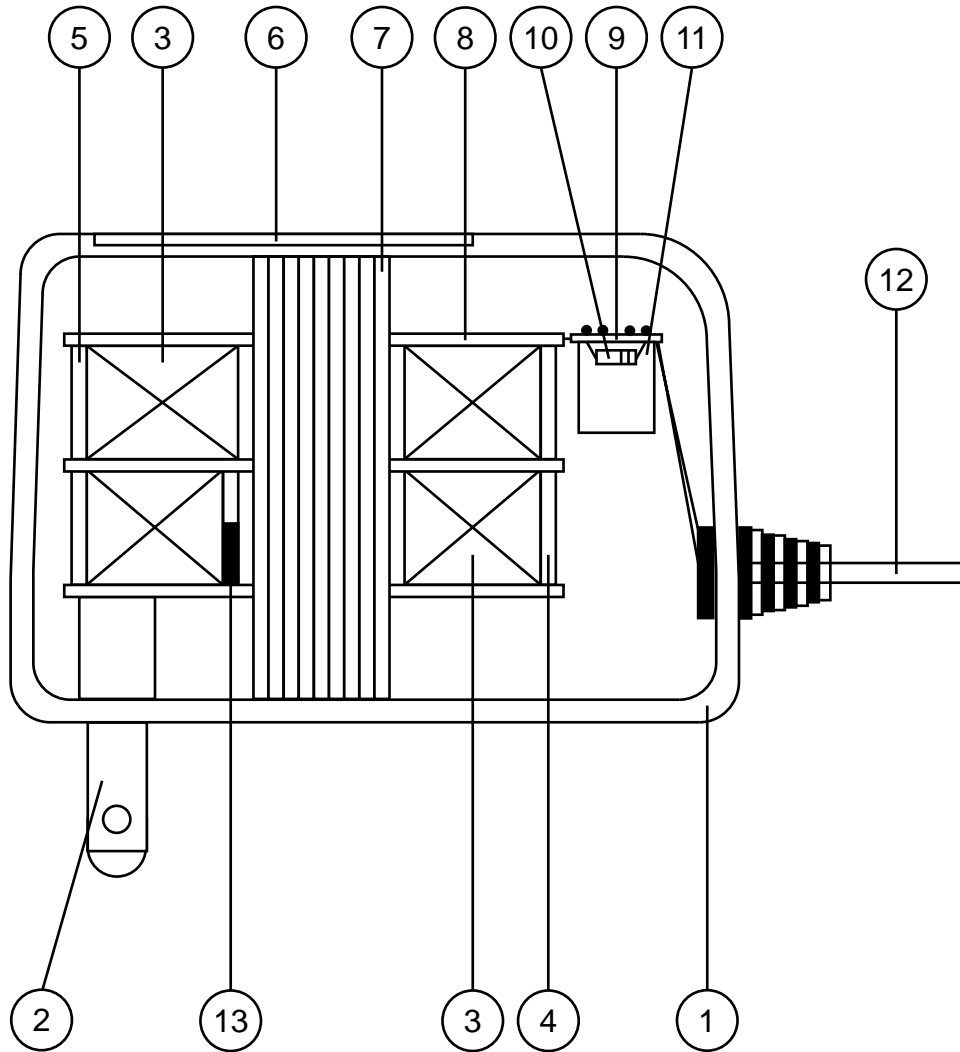

# 聯輝電機股份有限公司

No	DESCRIPTION	MATERIAL	SPEC. & Q'TY	MANUFACTURE
1	Enclosure	Noryl SE100 (GE) (E121562)		East Tung Jung Plastic Haroware Co., Ltd.
2	Primary Blades	Nickel Plating		Spread Profit Electronic (Dong Guan) Co., Ltd.
3	Enamelled Wire	Polyurethane Enameled Copper Wire(E85640(S))		Prosperity Wire And Cable Co., Ltd. Tai-Electric Wire & Cable Co., Ltd.
4	Primary Outerwarp	Polyesteer Film Tape (E81174(S))	0.05mm (4T)	Qun Yi Tape (Dongguan) Co., Ltd. Jeou Uei Co., Ltd.
5	Secondary Outerwarp	Polyesteer Film Tape (E81174(S))	0.025mm (2T)	Qun Yi Tape (Dongguan) Co., Ltd. Jeou Uei Co., Ltd.
6	Nameplate	P.V.C (MH26173(N))	0.35mm	Guang Ming You Tong Printing Factory
7	Core	Silicon Steel	0.5mm	Top Silicon Steel Corp.
8	Bobbin	70G33L(E41938)		East Tung Jung Plastic Haroware Co., Ltd.
9	Rectifier Board	P.C.B.(E105119)	94V-0	Chih Hsien Enterprise Co., Ltd.
10	Diodes	1N4001---5		Master Instrument Corporation Shanghai Ltd.
11	Capacitor	1000uf/25V		Fuh Yin Electronics Co., Ltd.
12	Output Cord	Flexible Cord(E112781)	AWG#22 UL2468	Ming Sheng Enterprise Co., Ltd.
13	Thermal Cutoff	L20 (E142267)	115°C	Joint Force Metal Research & Co.

# 聯輝電機股份有限公司

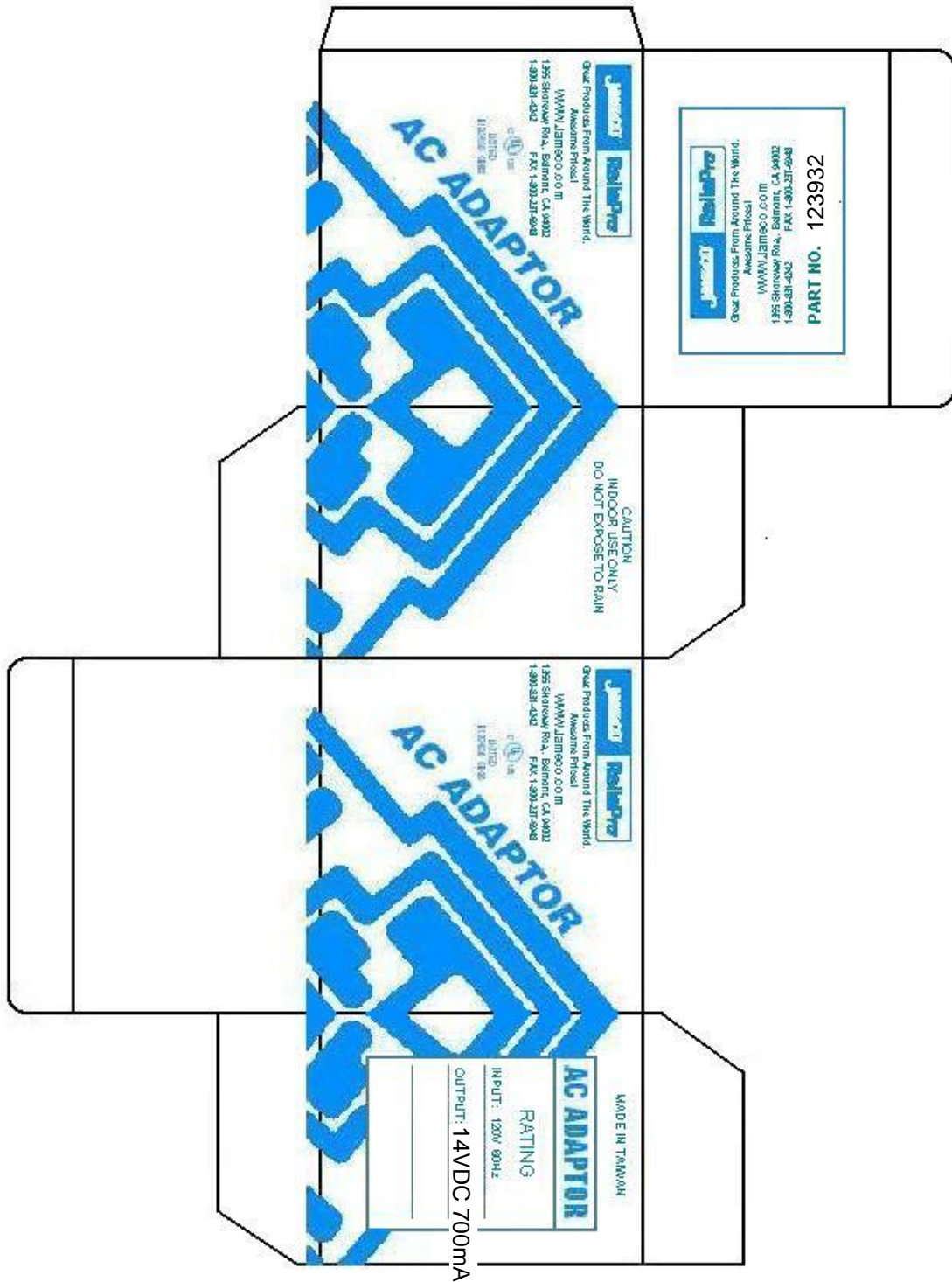

- 1.尺寸:100x60x74m/m No.11      2.磅數:450 磅  
 3.印刷:白底藍色字体及圖案      色號: PMS 300

出圖章	名稱	小紙盒	5				
	料號		4				
	發行日		3				
	核准	品保審核	製圖	2			
			李淑華	1			
			符號	日期	變更事項		修訂者
			單位:m/m	版次	圖號	CN-422	

# 聯輝電機股份有限公司

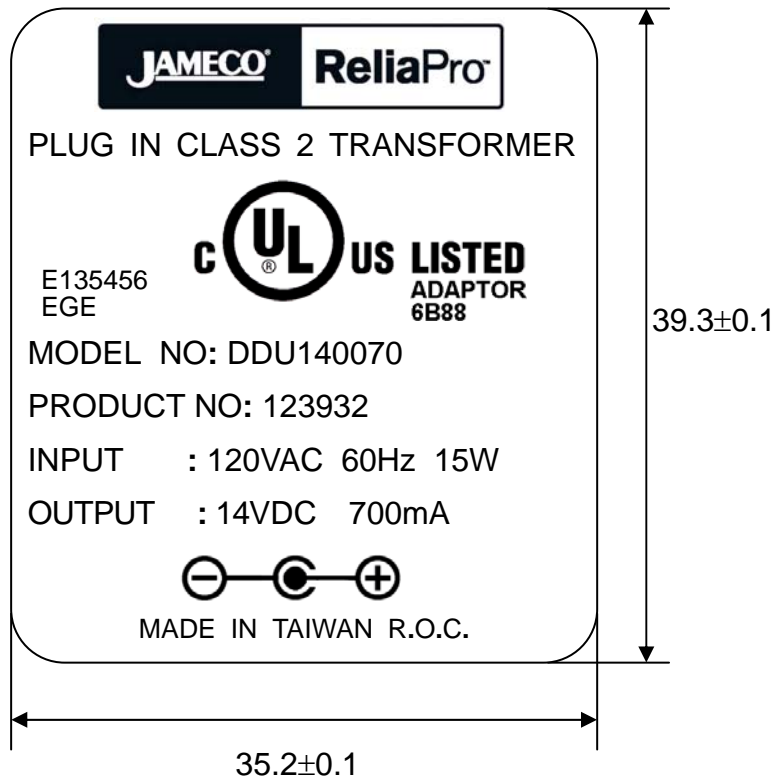

- 1.材質:PVC
- 2.厚度:0.35+0.2/-0.1
- 3.印刷:銀底黑字

出圖章	名稱	銘牌	5					
	料號		4					
	發行日	08.03.25	3					
	核准	品保審核	製圖	2				
			李淑華	1				
			符號	日期	變更事項		修訂者	審核者
			單位:m/m	版次	1-0	圖號		