

Distributed by:

JAMECO[®]
ELECTRONICS

www.Jameco.com ♦ 1-800-831-4242

The content and copyrights of the attached
material are the property of its owner.

Jameco Part Number 12562TI

CD4001B, CD4002B, CD4025B Types

CMOS NOR Gates

High-Voltage Types (20-Volt Rating)

Quad 2 Input – CD4001B

Dual 4 Input – CD4002B

Triple 3 Input – CD4025B

■ CD4001B, CD4002B, and CD4025B NOR gates provide the system designer with direct implementation of the NOR function and supplement the existing family of CMOS gates. All inputs and outputs are buffered.

The CD4001B, CD4002B, and CD4025B types are supplied in 14-lead hermetic dual-in-line ceramic packages (D and F suffixes), 14-lead dual-in-line plastic packages (E suffix), and in chip form (H suffix).

Features:

- Propagation delay time = 60 ns (typ.) at $C_L = 50 \text{ pF}$, $V_{DD} = 10 \text{ V}$
- Buffered inputs and outputs
- Standardized symmetrical output characteristics
- 100% tested for maximum quiescent current at 20 V
- 5-V, 10-V, and 15-V parametric ratings
- Maximum input current of 1 μA at 18 V over full package-temperature range; 100 nA at 18 V and 25°C
- Noise margin (over full package temperature range):
 - 1 V at $V_{DD} = 5 \text{ V}$
 - 2 V at $V_{DD} = 10 \text{ V}$
 - 2.5 V at $V_{DD} = 15 \text{ V}$
- Meets all requirements of JEDEC Tentative Standard No. 13B, "Standard Specifications for Description of "B" Series CMOS Devices"

STATIC ELECTRICAL CHARACTERISTICS

CHARACTER- ISTIC	CONDITIONS			LIMITS AT INDICATED TEMPERATURES (°C)							UNITS	
	V_O (V)	V_{IN} (V)	V_{DD} (V)							+25		
				-55	-40	+85	+125	Min.	Typ.	Max.		
Quiescent Device Current, $I_{DD} \text{ Max.}$	-	0,5	5	0.25	0.25	7.5	7.5	-	0.01	0.25	μA	
	-	0,10	10	0.5	0.5	15	15	-	0.01	0.5		
	-	0,15	15	1	1	30	30	-	0.01	1		
	-	0,20	20	5	5	150	150	-	0.02	5		
Output Low (Sink) Current $I_{OL} \text{ Min.}$	0.4	0,5	5	0.64	0.61	0.42	0.36	0.51	1	-	mA	
	0.5	0,10	10	1.6	1.5	1.1	0.9	1.3	2.6	-		
	1.5	0,15	15	4.2	4	2.8	2.4	3.4	6.8	-		
	13.5	0,15	15	-4.2	-4	-2.8	-2.4	-3.4	-6.8	-		
Output High (Source) Current, $I_{OH} \text{ Min.}$	4.6	0,5	5	-0.64	-0.61	-0.42	-0.36	-0.51	-1	-	mA	
	2.5	0,5	5	-2	-1.8	-1.3	-1.15	-1.6	-3.2	-		
	9.5	0,10	10	-1.6	-1.5	-1.1	-0.9	-1.3	-2.6	-		
	13.5	0,15	15	-4.2	-4	-2.8	-2.4	-3.4	-6.8	-		
Output Voltage: Low-Level, $V_{OL} \text{ Max.}$	-	0,5	5	0.05				-	0	0.05	V	
	-	0,10	10	0.05				-	0	0.05		
	-	0,15	15	0.05				-	0	0.05		
Output Voltage: High-Level, $V_{OH} \text{ Min.}$	-	0,5	5	4.95				4.95	5	-	V	
	-	0,10	10	9.95				9.95	10	-		
	-	0,15	15	14.95				14.95	15	-		
Input Low Voltage, $V_{IL} \text{ Max.}$	0.5,4.5	-	5	1.5				-	-	1.5	V	
	1,9	-	10	3				-	-	3		
	1.5,13.5	-	15	4				-	-	4		
Input High Voltage, $V_{IH} \text{ Min.}$	0.5	-	5	3.5				3.5	-	-	V	
	1	-	10	7				7	-	-		
	1.5	-	15	11				11	-	-		
Input Current $I_{IN} \text{ Max.}$		0,18	18	± 0.1	± 0.1	± 1	± 1	-	$\pm 10^{-5}$	± 0.1	μA	

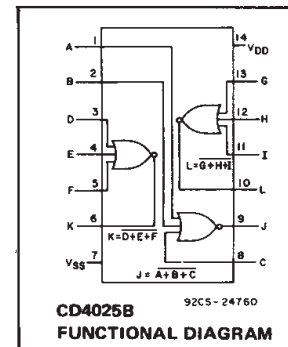
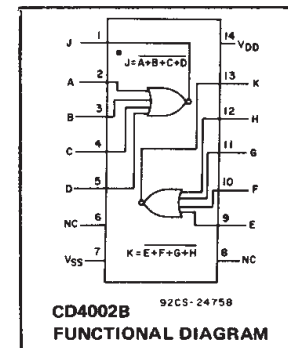
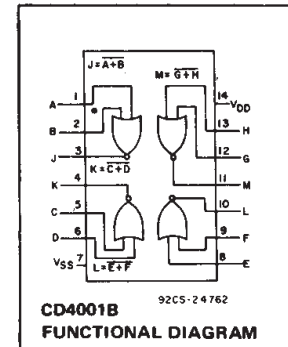

3
COMMERCIAL CMOS
HIGH VOLTAGE ICs

CD4001B, CD4002B, CD4025B Types

RECOMMENDED OPERATING CONDITIONS

For maximum reliability, nominal operating conditions should be selected so that operation is always within the following ranges:

CHARACTERISTIC	LIMITS		UNITS
	MIN.	MAX.	
Supply-Voltage Range (For T_A = Full Package Temperature Range)	3	18	V

MAXIMUM RATINGS, Absolute-Maximum Values:

DC SUPPLY-VOLTAGE RANGE, (V_{DD})

Voltages referenced to V_{SS} Terminal -0.5V to +20V

INPUT VOLTAGE RANGE, ALL INPUTS

..... -0.5V to V_{DD} +0.5V

DC INPUT CURRENT, ANY ONE INPUT

..... $\pm 10\mu\text{A}$

POWER DISSIPATION PER PACKAGE (P_D):

For $T_A = -55^\circ\text{C}$ to $+100^\circ\text{C}$ 500mW

For $T_A = +100^\circ\text{C}$ to $+125^\circ\text{C}$ Derate Linearly at 12mW/ $^\circ\text{C}$ to 200mW

DEVICE DISSIPATION PER OUTPUT TRANSISTOR

FOR $T_A = \text{FULL PACKAGE-TEMPERATURE RANGE (All Package Types)}$ 100mW

OPERATING-TEMPERATURE RANGE (T_A)

..... -55°C to $+125^\circ\text{C}$

STORAGE TEMPERATURE RANGE (T_{stg})

..... -65°C to $+150^\circ\text{C}$

LEAD TEMPERATURE (DURING SOLDERING):

At distance 1/16 \pm 1/32 inch (1.59 \pm 0.79mm) from case for 10s max $+265^\circ\text{C}$

DYNAMIC ELECTRICAL CHARACTERISTICS

At $T_A = 25^\circ\text{C}$; Input $t_r, t_f = 20\text{ ns}$, $C_L = 50\text{ pF}$, $R_L = 200\text{ k}\Omega$

CHARACTERISTIC	TEST CONDITIONS	ALL TYPES LIMITS		UNITS	
		V_{DD} VOLTS	TYP.		MAX.
Propagation Delay Time, t_{PHL}, t_{PLH}		5	125	250	ns
		10	60	120	
		15	45	90	
Transition Time, t_{THL}, t_{TLH}		5	100	200	ns
		10	50	100	
		15	40	80	
Input Capacitance, C_{IN}	Any Input		5	7.5	pF

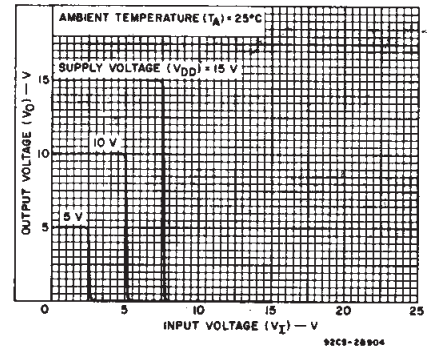

Fig. 1 - Typical voltage transfer characteristics.

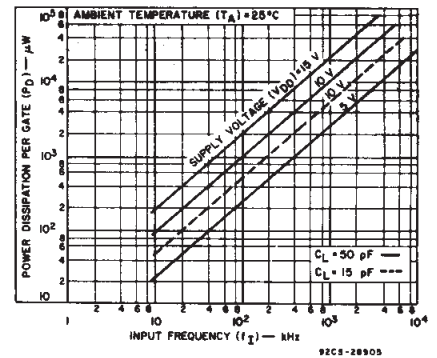

Fig. 2 - Typical power dissipation vs. frequency.

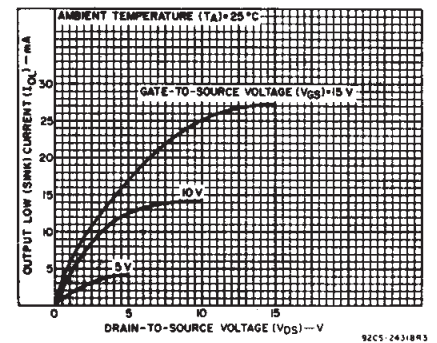

Fig. 3 - Typical output low (sink) current characteristics.

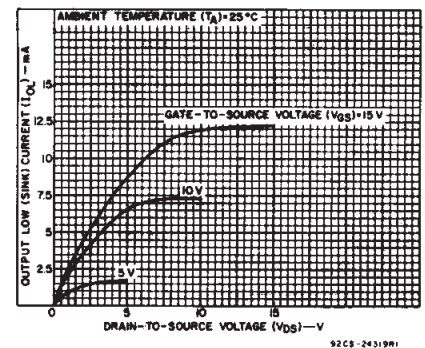

Fig. 4 - Minimum output low (sink) current characteristics.

CD4001B, CD4002B, CD4025B Types

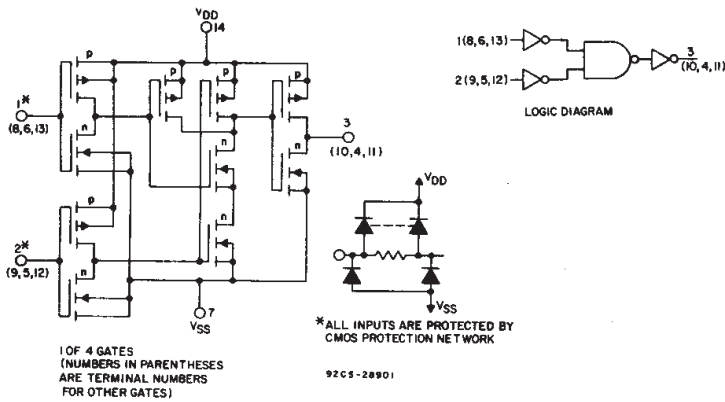

Fig.5 - Schematic and logic diagrams for CD4001B.

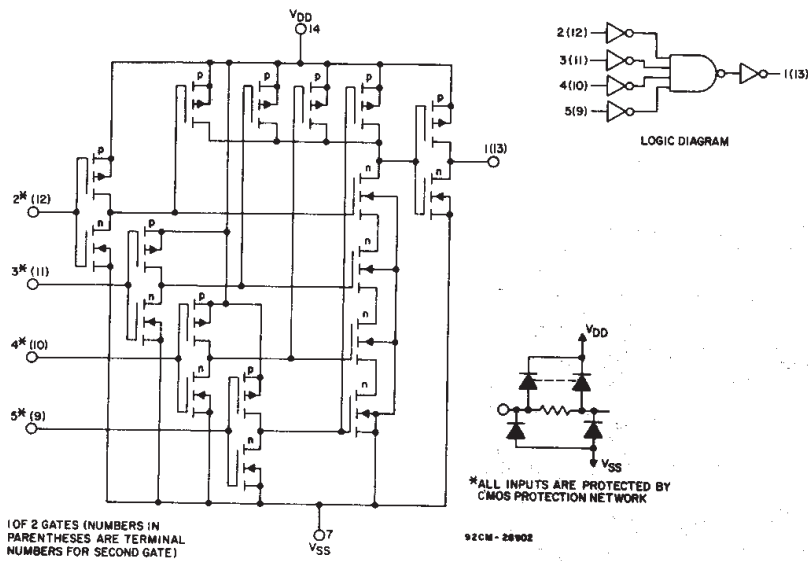

Fig.6 - Schematic and logic diagrams for CD4002B.

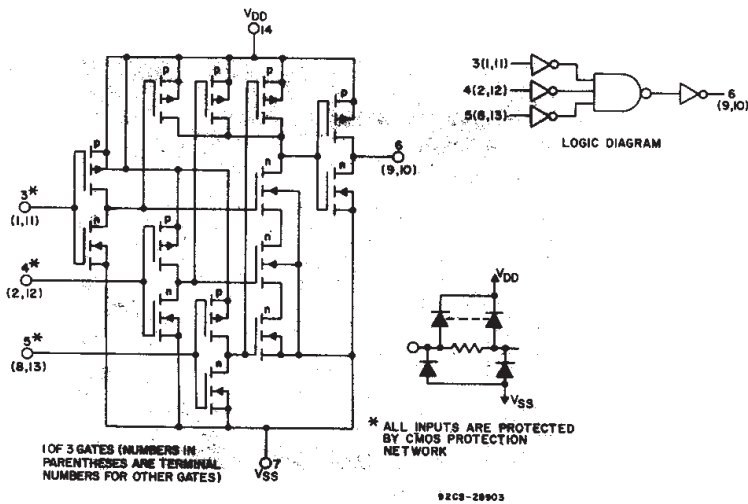

Fig.7 - Schematic and logic diagrams for CD4025B.

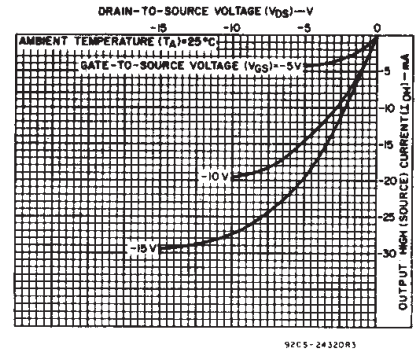

Fig.8 - Typical output high (source) current characteristics.

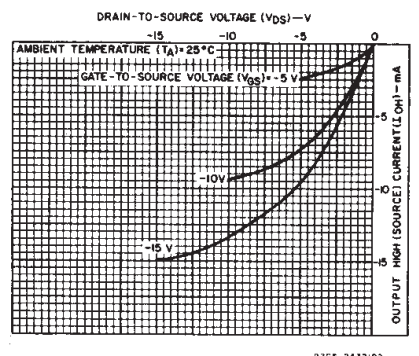

Fig.9 - Minimum output high (source) current characteristics.

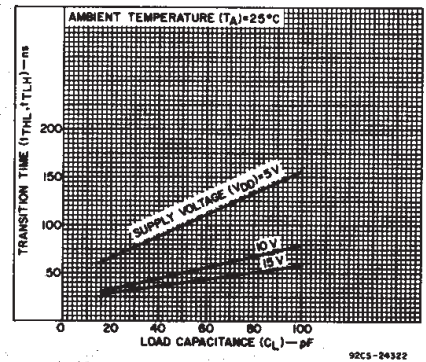

Fig.10 - Typical transition time vs. load capacitance.

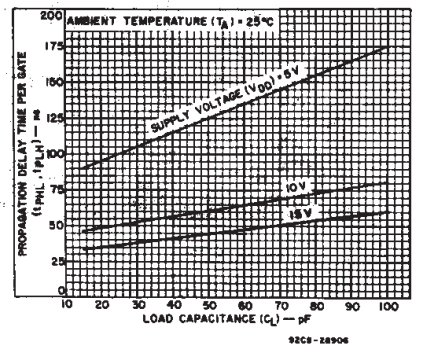

Fig.11 - Typical propagation delay time vs. load capacitance.

COMMERCIAL CMOS HIGH VOLTAGE ICs

CD4001B, CD4002B, CD4025B Types

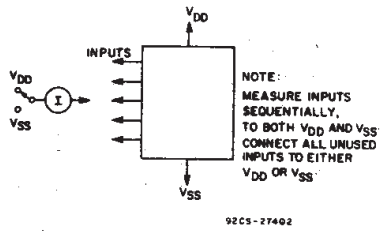

Fig. 13 - Input leakage current test circuit.

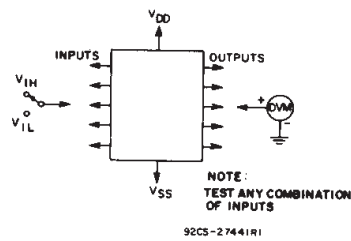

Fig. 14 - Input-voltage test circuit.

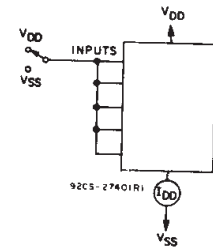
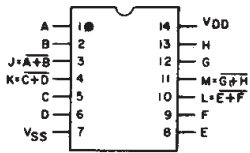
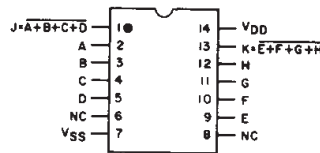

Fig. 15 - Quiescent-device current test circuit.

TERMINAL ASSIGNMENTS (TOP VIEW)



NC=NO CONNECTION
CD4001B



NC=NO CONNECTION
CD4002B

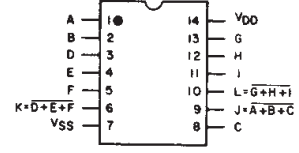

NC=NO CONNECTION
CD4025B

Chip Dimensions and Pad Layouts

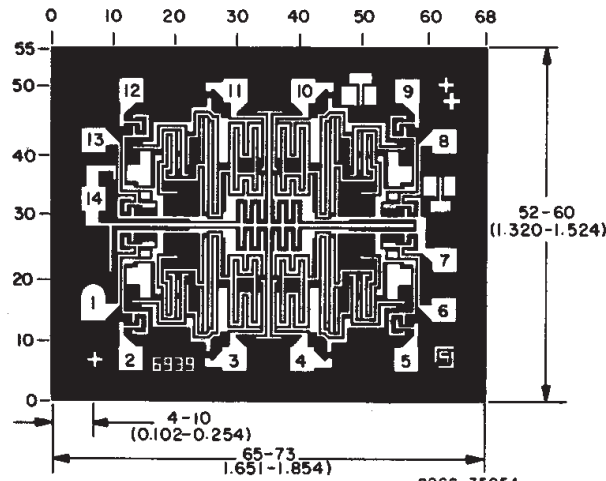

CD4001B

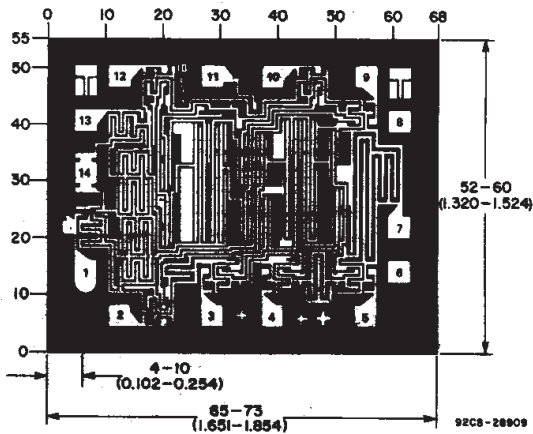

CD4002B

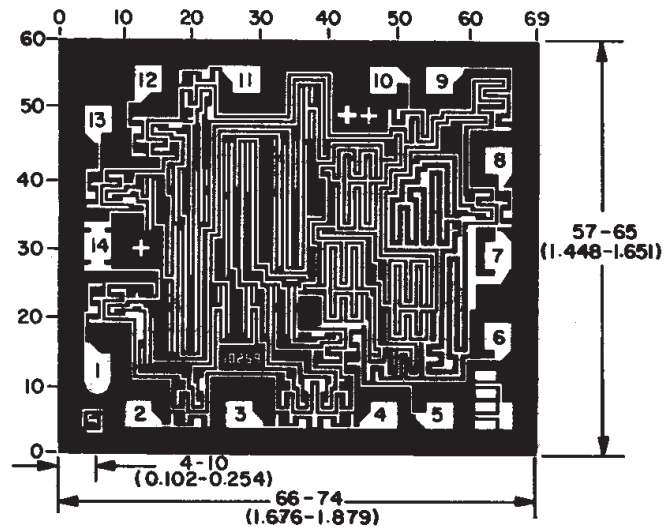

CD4025B

IMPORTANT NOTICE

Texas Instruments and its subsidiaries (TI) reserve the right to make changes to their products or to discontinue any product or service without notice, and advise customers to obtain the latest version of relevant information to verify, before placing orders, that information being relied on is current and complete. All products are sold subject to the terms and conditions of sale supplied at the time of order acknowledgement, including those pertaining to warranty, patent infringement, and limitation of liability.

TI warrants performance of its semiconductor products to the specifications applicable at the time of sale in accordance with TI's standard warranty. Testing and other quality control techniques are utilized to the extent TI deems necessary to support this warranty. Specific testing of all parameters of each device is not necessarily performed, except those mandated by government requirements.

CERTAIN APPLICATIONS USING SEMICONDUCTOR PRODUCTS MAY INVOLVE POTENTIAL RISKS OF DEATH, PERSONAL INJURY, OR SEVERE PROPERTY OR ENVIRONMENTAL DAMAGE ("CRITICAL APPLICATIONS"). TI SEMICONDUCTOR PRODUCTS ARE NOT DESIGNED, AUTHORIZED, OR WARRANTED TO BE SUITABLE FOR USE IN LIFE-SUPPORT DEVICES OR SYSTEMS OR OTHER CRITICAL APPLICATIONS. INCLUSION OF TI PRODUCTS IN SUCH APPLICATIONS IS UNDERSTOOD TO BE FULLY AT THE CUSTOMER'S RISK.

In order to minimize risks associated with the customer's applications, adequate design and operating safeguards must be provided by the customer to minimize inherent or procedural hazards.

TI assumes no liability for applications assistance or customer product design. TI does not warrant or represent that any license, either express or implied, is granted under any patent right, copyright, mask work right, or other intellectual property right of TI covering or relating to any combination, machine, or process in which such semiconductor products or services might be or are used. TI's publication of information regarding any third party's products or services does not constitute TI's approval, warranty or endorsement thereof.