

Distributed by:

JAMECO[®]
ELECTRONICS

www.Jameco.com ♦ 1-800-831-4242

The content and copyrights of the attached
material are the property of its owner.

Jameco Part Number 1315240

LM285, LM385B

Micropower Voltage Reference Diodes

The LM285/LM385 series are micropower two-terminal bandgap voltage regulator diodes. Designed to operate over a wide current range of 10 μ A to 20 mA, these devices feature exceptionally low dynamic impedance, low noise and stable operation over time and temperature. Tight voltage tolerances are achieved by on-chip trimming. The large dynamic operating range enables these devices to be used in applications with widely varying supplies with excellent regulation. Extremely low operating current make these devices ideal for micropower circuitry like portable instrumentation, regulators and other analog circuitry where extended battery life is required.

The LM285/LM385 series are packaged in a low cost TO-226 plastic case and are available in two voltage versions of 1.235 V and 2.500 V as denoted by the device suffix (see Ordering Information table). The LM285 is specified over a -40°C to $+85^{\circ}\text{C}$ temperature range while the LM385 is rated from 0°C to $+70^{\circ}\text{C}$.

The LM385 is also available in a surface mount plastic package in voltages of 1.235 V and 2.500 V.

Features

- Operating Current from 10 μ A to 20 mA
- 1.0%, 1.5%, 2.0% and 3.0% Initial Tolerance Grades
- Low Temperature Coefficient
- 1.0 Ω Dynamic Impedance
- Surface Mount Package Available
- Pb-Free Packages are Available

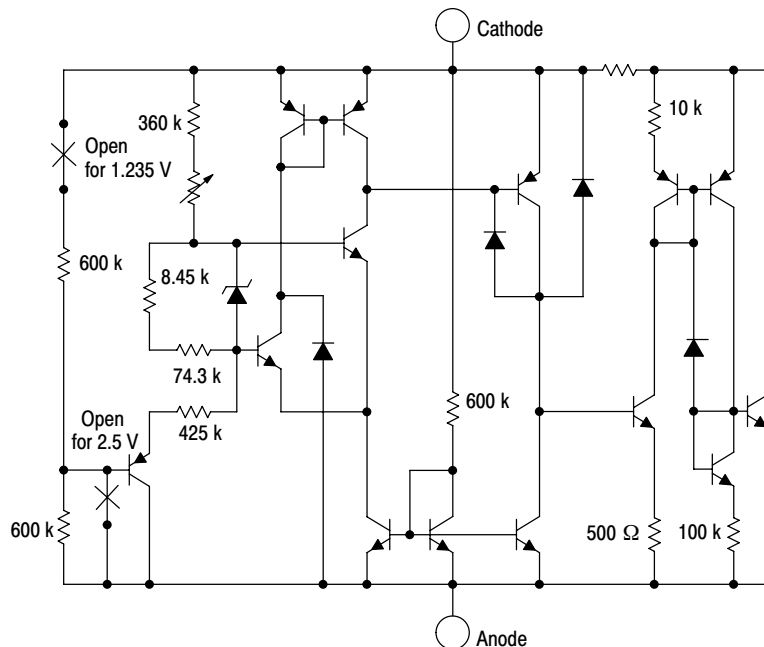

Figure 1. Representative Schematic Diagram



ON Semiconductor®

<http://onsemi.com>

MARKING DIAGRAMS



SOIC-8
D SUFFIX
CASE 751

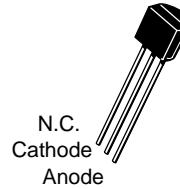
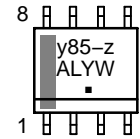

TO-92
(TO-226)
Z SUFFIX
CASE 29

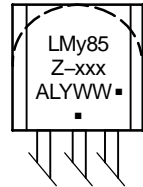

- xxx = 1.2 or 2.5
- y = 2 or 3
- z = 1 or 2
- A = Assembly Location
- L = Wafer Lot
- Y = Year
- W, WW = Work Week
- = Pb-Free Package

(Note: Microdot may be in either location)

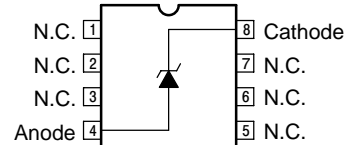
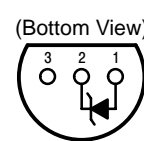

Standard Application

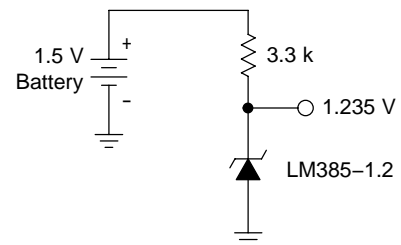

ORDERING INFORMATION

See detailed ordering and shipping information in the package dimensions section on page 6 of this data sheet.

LM285, LM385B

MAXIMUM RATINGS (T_A = 25°C, unless otherwise noted)

Rating	Symbol	Value	Unit
Reverse Current	I _R	30	mA
Forward Current	I _F	10	mA
Operating Ambient Temperature Range	T _A	-40 to +85 0 to +70	°C
Operating Junction Temperature	T _J	+150	°C
Storage Temperature Range	T _{stg}	-65 to +150	°C
Electrostatic Discharge Sensitivity (ESD) Human Body Model (HBM) Machine Model (MM) Charged Device Model (CDM)	ESD	4000 400 2000	V

Maximum ratings are those values beyond which device damage can occur. Maximum ratings applied to the device are individual stress limit values (not normal operating conditions) and are not valid simultaneously. If these limits are exceeded, device functional operation is not implied, damage may occur and reliability may be affected.

ELECTRICAL CHARACTERISTICS (T_A = 25°C, unless otherwise noted)

Characteristic	Symbol	LM285-1.2			LM385-1.2/LM385B-1.2			Unit
		Min	Typ	Max	Min	Typ	Max	
Reverse Breakdown Voltage (I _{Rmin} ≤ I _R ≤ 20 mA) LM285-1.2/LM385B-1.2 T _A = T _{low} to T _{high} (Note 1) LM385-1.2 T _A = T _{low} to T _{high} (Note 1)	V _{(BR)R}	1.223 1.200	1.235 –	1.247 1.270	1.223 1.210	1.235 –	1.247 1.260	V
Minimum Operating Current T _A = 25°C T _A = T _{low} to T _{high} (Note 1)	I _{Rmin}	– –	8.0 –	10 20	– –	8.0 –	15 20	μA
Reverse Breakdown Voltage Change with Current I _{Rmin} ≤ I _R ≤ 1.0 mA, T _A = +25°C T _A = T _{low} to T _{high} (Note 1) 1.0 mA ≤ I _R ≤ 20 mA, T _A = +25°C T _A = T _{low} to T _{high} (Note 1)	ΔV _{(BR)R}	– – –	– – –	1.0 1.5 10 20	– – – –	– – – –	1.0 1.5 20 25	mV
Reverse Dynamic Impedance I _R = 100 μA, T _A = +25°C	Z	–	0.6	–	–	0.6	–	Ω
Average Temperature Coefficient 10 μA ≤ I _R ≤ 20 mA, T _A = T _{low} to T _{high} (Note 1)	ΔV _{(BR)R} /ΔT	–	80	–	–	80	–	ppm/°C
Wideband Noise (RMS) I _R = 100 μA, 10 Hz ≤ f ≤ 10 kHz	n	–	60	–	–	60	–	μV
Long Term Stability I _R = 100 μA, T _A = +25°C ± 0.1°C	S	–	20	–	–	20	–	ppm/kHR
Reverse Breakdown Voltage (I _{Rmin} ≤ I _R ≤ 20 mA) LM285-2.5/LM385B-2.5 T _A = T _{low} to T _{high} (Note 1) LM385-2.5 T _A = T _{low} to T _{high} (Note 1)	V _{(BR)R}	2.462 2.415	2.5 –	2.538 2.585	2.462 2.436	2.5 –	2.538 2.564	V
Minimum Operating Current T _A = 25°C T _A = T _{low} to T _{high} (Note 1)	I _{Rmin}	– –	13 –	20 30	– –	13 –	20 30	μA

- T_{low} = -40°C for LM285-1.2, LM285-2.5
 T_{high} = +85°C for LM285-1.2, LM285-2.5
 T_{low} = 0°C for LM385-1.2, LM385B-1.2, LM385-2.5, LM385B-2.5
 T_{high} = +70°C for LM385-1.2, LM385B-1.2, LM385-2.5, LM385B-2.5

LM285, LM385B

ELECTRICAL CHARACTERISTICS ($T_A = 25^\circ\text{C}$, unless otherwise noted)

Characteristic	Symbol	LM285-1.2			LM385-1.2/LM385B-1.2			Unit
		Min	Typ	Max	Min	Typ	Max	
Reverse Breakdown Voltage Change with Current $I_{Rmin} \leq I_R \leq 1.0 \text{ mA}$, $T_A = +25^\circ\text{C}$ $T_A = T_{low}$ to T_{high} (Note 2) $1.0 \text{ mA} \leq I_R \leq 20 \text{ mA}$, $T_A = +25^\circ\text{C}$ $T_A = T_{low}$ to T_{high} (Note 2)	$\Delta V_{(BR)R}$	-	-	1.0	-	-	2.0	mV
		-	-	1.5	-	-	2.5	
		-	-	10	-	-	20	
		-	-	20	-	-	25	
Reverse Dynamic Impedance $I_R = 100 \mu\text{A}$, $T_A = +25^\circ\text{C}$	Z	-	0.6	-	-	0.6	-	Ω
Average Temperature Coefficient $20 \mu\text{A} \leq I_R \leq 20 \text{ mA}$, $T_A = T_{low}$ to T_{high} (Note 2)	$\Delta V_{(BR)}/\Delta T$	-	80	-	-	80	-	ppm/ $^\circ\text{C}$
Wideband Noise (RMS) $I_R = 100 \mu\text{A}$, $10 \text{ Hz} \leq f \leq 10 \text{ kHz}$	n	-	120	-	-	120	-	μV
Long Term Stability $I_R = 100 \mu\text{A}$, $T_A = +25^\circ\text{C} \pm 0.1^\circ\text{C}$	S	-	20	-	-	20	-	ppm/kHR

2. $T_{low} = -40^\circ\text{C}$ for LM285-1.2, LM285-2.5
 $T_{high} = +85^\circ\text{C}$ for LM285-1.2, LM285-2.5
 $T_{low} = 0^\circ\text{C}$ for LM385-1.2, LM385B-1.2, LM385-2.5, LM385B-2.5
 $T_{high} = +70^\circ\text{C}$ for LM385-1.2, LM385B-1.2, LM385-2.5, LM385B-2.5

LM285, LM385B

TYPICAL PERFORMANCE CURVES FOR LM285-1.2/385-1.2/385B-1.2

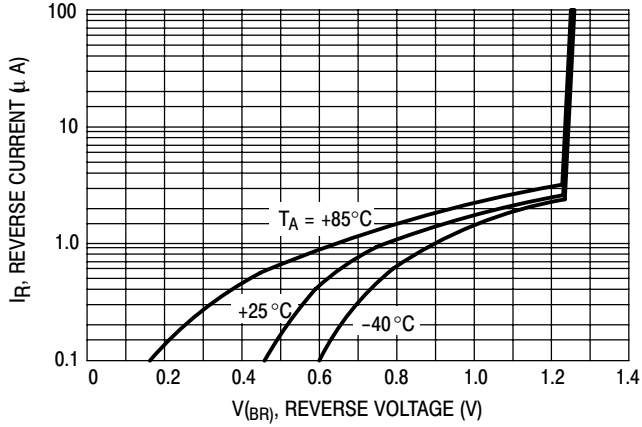

Figure 2. Reverse Characteristics

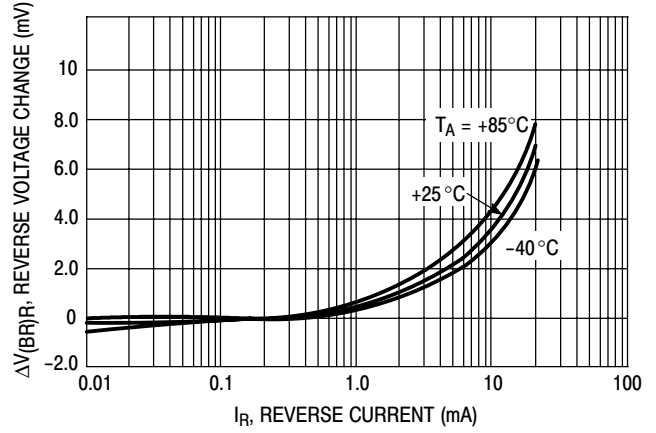

Figure 3. Reverse Characteristics

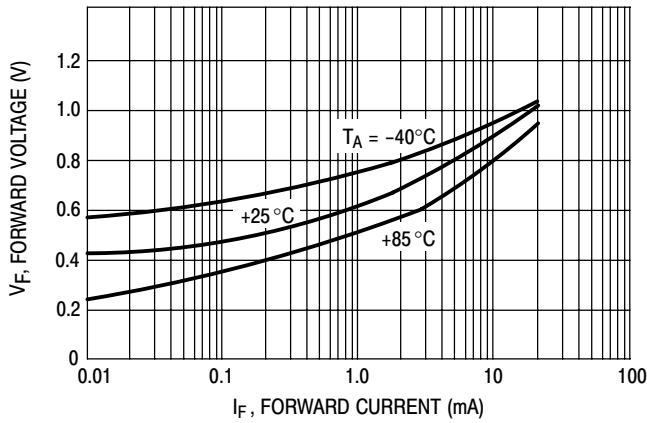

Figure 4. Forward Characteristics

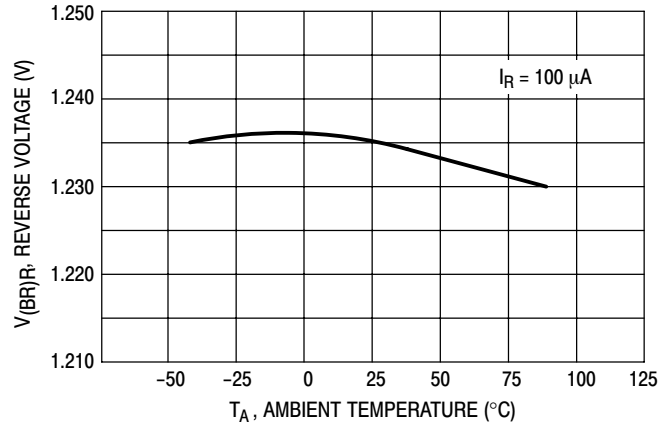

Figure 5. Temperature Drift

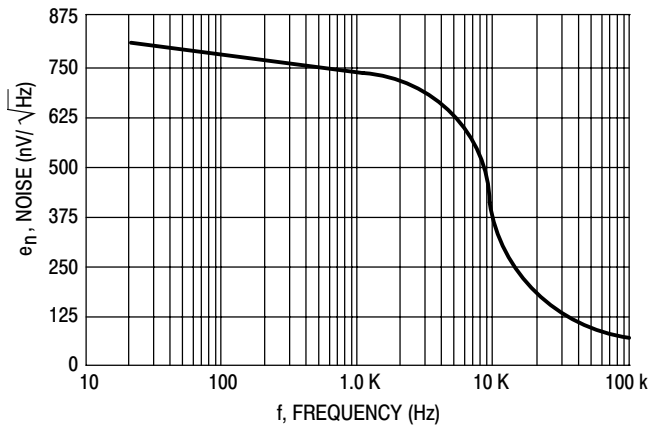

Figure 6. Noise Voltage

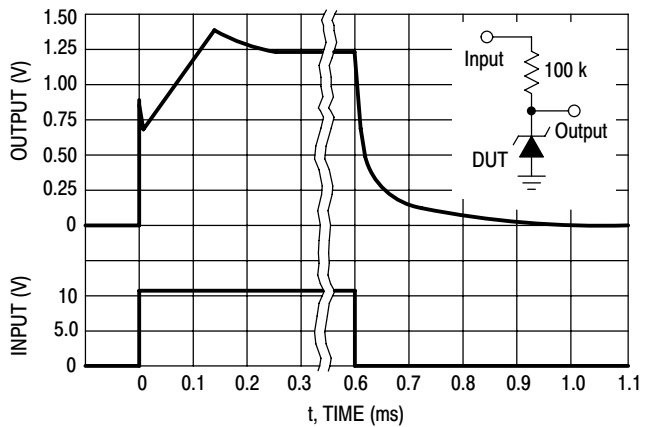

Figure 7. Response Time

LM285, LM385B

TYPICAL PERFORMANCE CURVES FOR LM285-2.5/385-2.5/385B-2.5

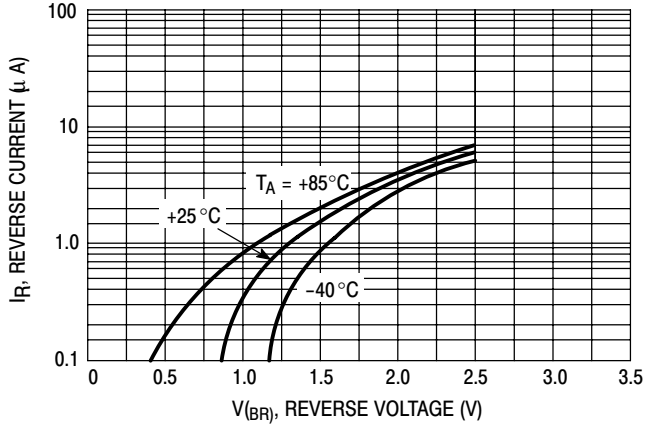

Figure 8. Reverse Characteristics

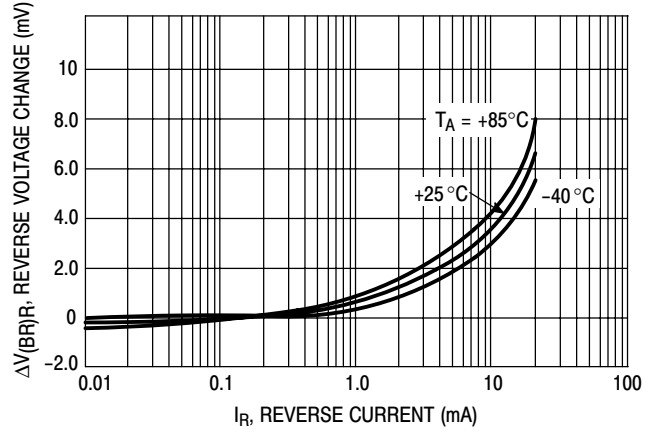

Figure 9. Reverse Characteristics

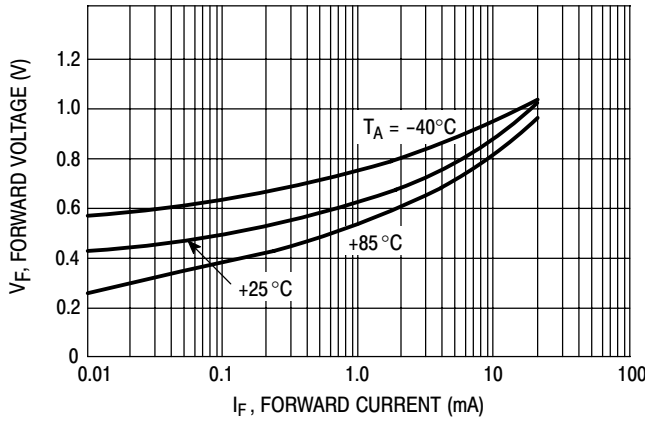

Figure 10. Forward Characteristics

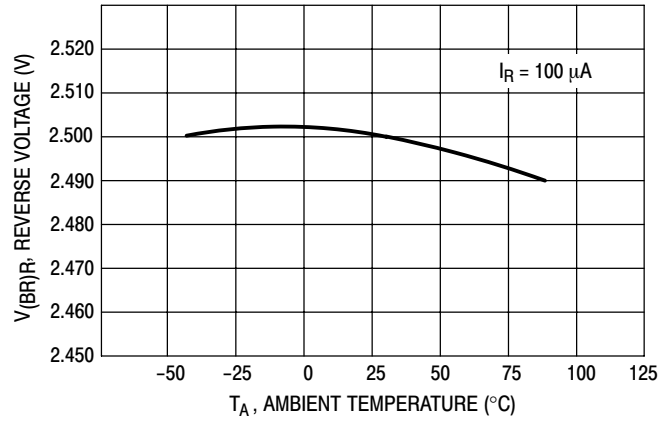

Figure 11. Temperature Drift

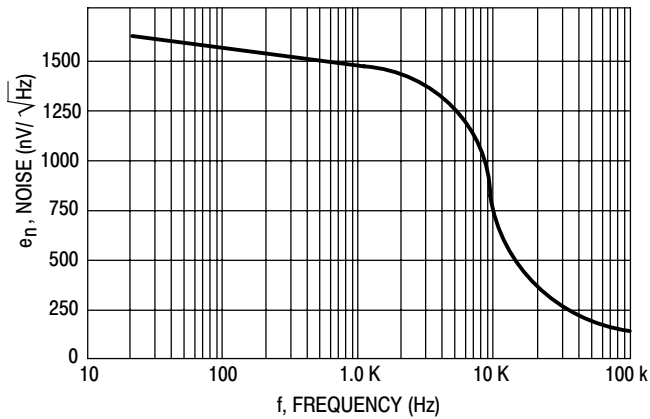

Figure 12. Noise Voltage

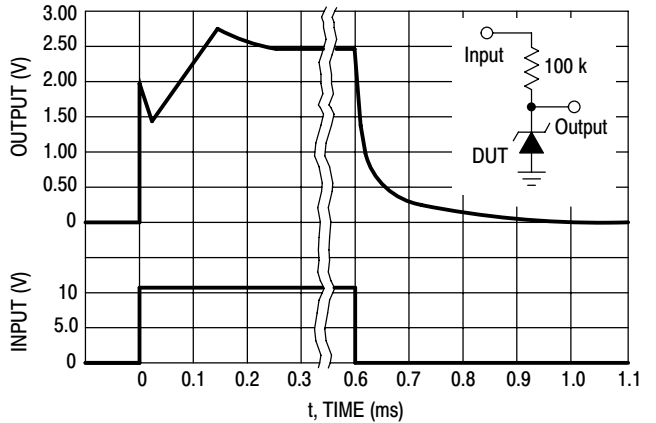

Figure 13. Response Time

LM285, LM385B

ORDERING INFORMATION

Device	Operating Temperature Range	Reverse Break-Down Voltage	Package	Shipping [†]		
LM285D-1.2	T _A = -40°C to +85°C	1.235 V	SOIC-8	98 Units / Rail		
LM285D-1.2G			SOIC-8 (Pb-Free)	98 Units / Rail		
LM285D-1.2R2			SOIC-8	2500 / Tape & Reel		
LM285D-1.2R2G			SOIC-8 (Pb-Free)	2500 / Tape & Reel		
LM285D-2.5		2.500 V	SOIC-8	98 Units / Rail		
LM285D-2.5G			SOIC-8 (Pb-Free)	98 Units / Rail		
LM285D-2.5R2			SOIC-8	2500 / Tape & Reel		
LM285D-2.5R2G			SOIC-8 (Pb-Free)	2500 / Tape & Reel		
LM285Z-1.2		T _A = -40°C to +85°C	1.235 V	TO-92	2000 Units / Bag	
LM285Z-1.2G				TO-92 (Pb-Free)	2000 Units / Bag	
LM285Z-2.5			2.500 V	TO-92	2000 Units / Bag	
LM285Z-2.5G				TO-92 (Pb-Free)	2000 Units / Bag	
LM285Z-1.2RA			1.235 V	TO-92	2000 / Tape & Reel	
LM285Z-1.2RAG				TO-92 (Pb-Free)	2000 / Tape & Reel	
LM285Z-2.5RA			2.500 V	TO-92	2000 / Tape & Reel	
LM285Z-2.5RAG				TO-92 (Pb-Free)	2000 / Tape & Reel	
LM285Z-2.5RP				TO-92	2000 Units / Fan-Fold	
LM285Z-2.5RPG				TO-92 (Pb-Free)	2000 Units / Fan-Fold	
LM385BD-1.2			T _A = 0°C to +70°C	1.235 V	SOIC-8	98 Units / Rail
LM385BD-1.2G					SOIC-8 (Pb-Free)	98 Units / Rail
LM385BD-1.2R2	SOIC-8	2500 / Tape & Reel				
LM385BD-1.2R2G	SOIC-8 (Pb-Free)	2500 / Tape & Reel				
LM385BD-2.5	2.500 V	SOIC-8		98 Units / Rail		
LM385BD-2.5G		SOIC-8 (Pb-Free)		98 Units / Rail		
LM385BD-2.5R2		SOIC-8		2500 / Tape & Reel		
LM385BD-2.5R2G		SOIC-8 (Pb-Free)		2500 / Tape & Reel		
LM385BZ-1.2	1.235 V	TO-92		2000 Units / Bag		
LM385BZ-1.2G		TO-92 (Pb-Free)		2000 Units / Bag		
LM385BZ-1.2RA		TO-92		2000 / Tape & Reel		
LM385BZ-1.2RAG		TO-92 (Pb-Free)		2000 / Tape & Reel		

[†]For information on tape and reel specifications, including part orientation and tape sizes, please refer to our Tape and Reel Packaging Specifications Brochure, BRD8011/D.

LM285, LM385B

ORDERING INFORMATION

Device	Operating Temperature Range	Reverse Break-Down Voltage	Package	Shipping [†]	
LM385BZ-2.5	$T_A = 0^\circ\text{C to } +70^\circ\text{C}$	2.500 V	TO-92	2000 Units / Bag	
LM385BZ-2.5G			TO-92 (Pb-Free)	2000 Units / Bag	
LM385BZ-2.5RA			TO-92	2000 / Tape & Reel	
LM385BZ-2.5RAG			TO-92 (Pb-Free)	2000 / Tape & Reel	
LM385D-1.2		1.235 V	1.235 V	SOIC-8	98 Units / Rail
LM385D-1.2G				SOIC-8 (Pb-Free)	98 Units / Rail
LM385D-1.2R2				SOIC-8	2500 / Tape & Reel
LM385D-1.2R2G				SOIC-8 (Pb-Free)	2500 / Tape & Reel
LM385D-2.5		2.500 V	2.500 V	SOIC-8	98 Units / Rail
LM385D-2.5G				SOIC-8 (Pb-Free)	98 Units / Rail
LM385D-2.5R2				SOIC-8	2500 / Tape & Reel
LM385D-2.5R2G				SOIC-8 (Pb-Free)	2500 / Tape & Reel
LM385Z-1.2		1.235 V	1.235 V	TO-92	2000 Units / Bag
LM385Z-1.2G				TO-92 (Pb-Free)	2000 Units / Bag
LM385Z-1.2RA				TO-92	2000 / Tape & Reel
LM385Z-1.2RAG				TO-92 (Pb-Free)	2000 / Tape & Reel
LM385Z-1.2RP				TO-92	2000 / Ammo Box
LM385Z-1.2RPG				TO-92 (Pb-Free)	2000 / Ammo Box
LM385Z-2.5		2.500 V	2.500 V	TO-92	2000 Units / Bag
LM385Z-2.5G				TO-92 (Pb-Free)	2000 Units / Bag
LM385Z-2.5RP	TO-92			2000 / Ammo Box	
LM385Z-2.5RPG	TO-92 (Pb-Free)			2000 / Ammo Box	

[†]For information on tape and reel specifications, including part orientation and tape sizes, please refer to our Tape and Reel Packaging Specifications Brochure, BRD8011/D.

LM285, LM385B

PACKAGE DIMENSIONS

SOIC-8 NB
CASE 751-07
ISSUE AG

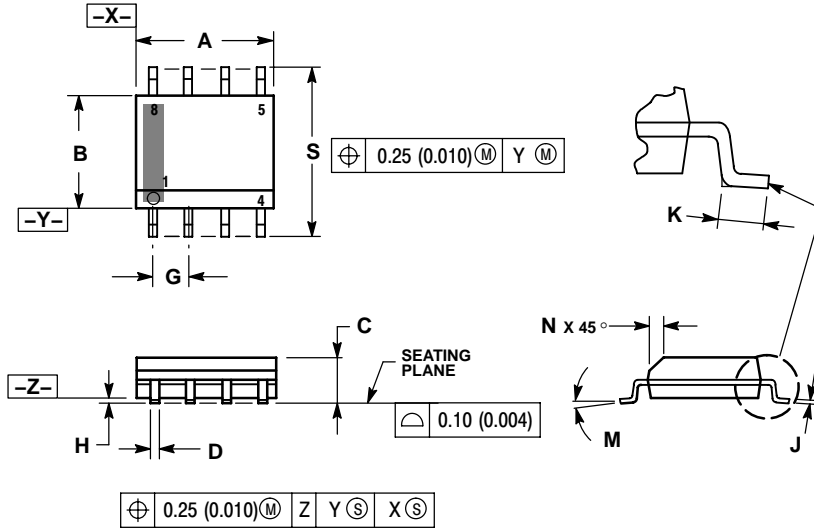

NOTES:

1. DIMENSIONING AND TOLERANCING PER ANSI Y14.5M, 1982.
2. CONTROLLING DIMENSION: MILLIMETER.
3. DIMENSION A AND B DO NOT INCLUDE MOLD PROTRUSION.
4. MAXIMUM MOLD PROTRUSION 0.15 (0.006) PER SIDE.
5. DIMENSION D DOES NOT INCLUDE DAMBAR PROTRUSION. ALLOWABLE DAMBAR PROTRUSION SHALL BE 0.127 (0.005) TOTAL IN EXCESS OF THE D DIMENSION AT MAXIMUM MATERIAL CONDITION.
6. 751-01 THRU 751-06 ARE OBSOLETE. NEW STANDARD IS 751-07.

DIM	MILLIMETERS		INCHES	
	MIN	MAX	MIN	MAX
A	4.80	5.00	0.189	0.197
B	3.80	4.00	0.150	0.157
C	1.35	1.75	0.053	0.069
D	0.33	0.51	0.013	0.020
G	1.27 BSC		0.050 BSC	
H	0.10	0.25	0.004	0.010
J	0.19	0.25	0.007	0.010
K	0.40	1.27	0.016	0.050
M	0°	8°	0°	8°
N	0.25	0.50	0.010	0.020
S	5.80	6.20	0.228	0.244

SOLDERING FOOTPRINT*

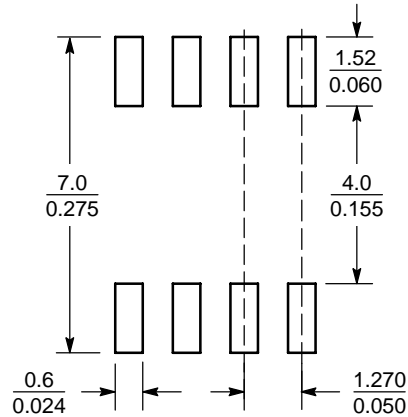

SCALE 6:1 (mm/inches)

*For additional information on our Pb-Free strategy and soldering details, please download the ON Semiconductor Soldering and Mounting Techniques Reference Manual, SOLDERRM/D.

LM285, LM385B

PACKAGE DIMENSIONS

TO-92 (TO-226) CASE 29-11 ISSUE AL

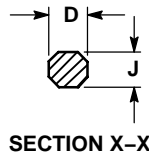
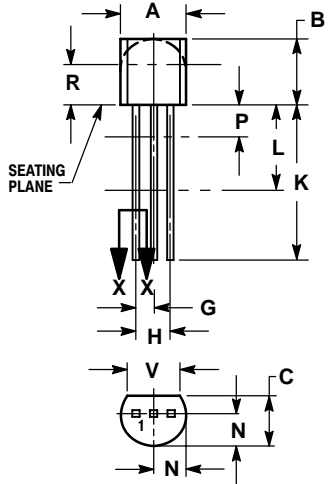

NOTES:

1. DIMENSIONING AND TOLERANCING PER ANSI Y14.5M, 1982.
2. CONTROLLING DIMENSION: INCH.
3. CONTOUR OF PACKAGE BEYOND DIMENSION R IS UNCONTROLLED.
4. LEAD DIMENSION IS UNCONTROLLED IN P AND BEYOND DIMENSION K MINIMUM.

DIM	INCHES		MILLIMETERS	
	MIN	MAX	MIN	MAX
A	0.175	0.205	4.45	5.20
B	0.170	0.210	4.32	5.33
C	0.125	0.165	3.18	4.19
D	0.016	0.021	0.407	0.533
G	0.045	0.055	1.15	1.39
H	0.095	0.105	2.42	2.66
J	0.015	0.020	0.39	0.50
K	0.500	---	12.70	---
L	0.250	---	6.35	---
N	0.080	0.105	2.04	2.66
P	---	0.100	---	2.54
R	0.115	---	2.93	---
V	0.135	---	3.43	---

ON Semiconductor and are registered trademarks of Semiconductor Components Industries, LLC (SCILLC). SCILLC reserves the right to make changes without further notice to any products herein. SCILLC makes no warranty, representation or guarantee regarding the suitability of its products for any particular purpose, nor does SCILLC assume any liability arising out of the application or use of any product or circuit, and specifically disclaims any and all liability, including without limitation special, consequential or incidental damages. "Typical" parameters which may be provided in SCILLC data sheets and/or specifications can and do vary in different applications and actual performance may vary over time. All operating parameters, including "Typicals" must be validated for each customer application by customer's technical experts. SCILLC does not convey any license under its patent rights nor the rights of others. SCILLC products are not designed, intended, or authorized for use as components in systems intended for surgical implant into the body, or other applications intended to support or sustain life, or for any other application in which the failure of the SCILLC product could create a situation where personal injury or death may occur. Should Buyer purchase or use SCILLC products for any such unintended or unauthorized application, Buyer shall indemnify and hold SCILLC and its officers, employees, subsidiaries, affiliates, and distributors harmless against all claims, costs, damages, and expenses, and reasonable attorney fees arising out of, directly or indirectly, any claim of personal injury or death associated with such unintended or unauthorized use, even if such claim alleges that SCILLC was negligent regarding the design or manufacture of the part. SCILLC is an Equal Opportunity/Affirmative Action Employer. This literature is subject to all applicable copyright laws and is not for resale in any manner.

PUBLICATION ORDERING INFORMATION

LITERATURE FULFILLMENT:

Literature Distribution Center for ON Semiconductor
P.O. Box 61312, Phoenix, Arizona 85082-1312 USA
Phone: 480-829-7710 or 800-344-3860 Toll Free USA/Canada
Fax: 480-829-7709 or 800-344-3867 Toll Free USA/Canada
Email: orderlit@onsemi.com

N. American Technical Support: 800-282-9855 Toll Free
USA/Canada

Japan: ON Semiconductor, Japan Customer Focus Center
2-9-1 Kamimeguro, Meguro-ku, Tokyo, Japan 153-0051
Phone: 81-3-5773-3850

ON Semiconductor Website: <http://onsemi.com>

Order Literature: <http://www.onsemi.com/litorder>

For additional information, please contact your local Sales Representative.