

Distributed by:



www.Jameco.com ♦ 1-800-831-4242

The content and copyrights of the attached material are the property of its owner.



November 1983
Revised August 2000

CD4066BC Quad Bilateral Switch

General Description

The CD4066BC is a quad bilateral switch intended for the transmission or multiplexing of analog or digital signals. It is pin-for-pin compatible with CD4016BC, but has a much lower "ON" resistance, and "ON" resistance is relatively constant over the input-signal range.

Features

- Wide supply voltage range 3V to 15V
- High noise immunity $0.45 V_{DD}$ (typ.)
- Wide range of digital and $\pm 7.5 V_{PEAK}$ analog switching
- "ON" resistance for 15V operation 80Ω
- Matched "ON" resistance $\Delta R_{ON} = 5 \Omega$ (typ.) over 15V signal input
- "ON" resistance flat over peak-to-peak signal range
- High "ON"/"OFF" 65 dB (typ.) output voltage ratio @ $f_{is} = 10 \text{ kHz}$, $R_L = 10 \text{ k}\Omega$

- High degree linearity 0.1% distortion (typ.)
High degree linearity @ $f_{is} = 1 \text{ kHz}$, $V_{is} = 5V_{P-P}$
High degree linearity $V_{DD} - V_{SS} = 10V$, $R_L = 10 \text{ k}\Omega$
- Extremely low "OFF" 0.1 nA (typ.) switch leakage: @ $V_{DD} - V_{SS} = 10V$, $T_A = 25^\circ\text{C}$
- Extremely high control input impedance $10^{12} \Omega$ (typ.)
- Low crosstalk -50 dB (typ.) between switches @ $f_{is} = 0.9 \text{ MHz}$, $R_L = 1 \text{ k}\Omega$
- Frequency response, switch "ON" 40 MHz (typ.)

Applications

- Analog signal switching/multiplexing
- Signal gating
- Squelch control
- Chopper
- Modulator/Demodulator
- Commutating switch
- Digital signal switching/multiplexing
- CMOS logic implementation
- Analog-to-digital/digital-to-analog conversion
- Digital control of frequency, impedance, phase, and analog-signal-gain

Ordering Code:

Order Number	Package Number	Package Description
CD4066BCM	M14A	14-Lead Small Outline Integrated Circuit (SOIC), JEDEC MS-120, 0.150 Narrow
CD4066BCSJ	M14D	14-Lead Small Outline Package (SOP), EIAJ TYPE II, 5.3mm Wide
CD4066BCN	N14A	14-Lead Plastic Dual-In-Line Package (PDIP), JEDEC MS-001, 0.300 Wide

Devices also available in Tape and Reel. Specify by appending suffix letter "X" to the ordering code.

Connection Diagram

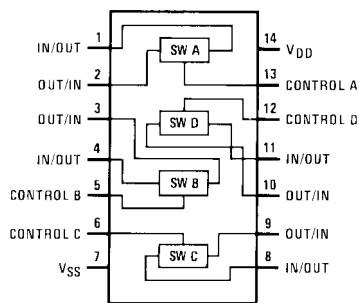

Schematic Diagram

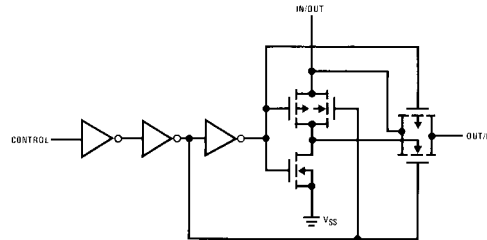

Absolute Maximum Ratings

(Note 1)

(Note 2)

Supply Voltage (V_{DD})	-0.5V to +18V
Input Voltage (V_{IN})	-0.5V to $V_{CC}+0.5V$
Storage Temperature Range (T_S)	-65°C to +150°C
Power Dissipation (P_D)	
Dual-In-Line	700 mW
Small Outline	500 mW
Lead Temperature (T_L)	
(Soldering, 10 seconds)	300°C

Recommended Operating Conditions (Note 2)

Supply Voltage (V_{DD})	3V to 15V
Input Voltage (V_{IN})	0V to V_{DD}
Operating Temperature Range (T_A)	-40°C to +85°C

Note 1: "Absolute Maximum Ratings" are those values beyond which the safety of the device cannot be guaranteed. They are not meant to imply that the devices should be operated at these limits. The tables of "Recommended Operating Conditions" and "Electrical Characteristics" provide conditions for actual device operation.

Note 2: $V_{SS} = 0V$ unless otherwise specified.

DC Electrical Characteristics (Note 2)

Symbol	Parameter	Conditions	-40°C		+25°C			+85°C		Units
			Min	Max	Min	Typ	Max	Min	Max	
I_{DD}	Quiescent Device Current	$V_{DD} = 5V$		1.0		0.01	1.0		7.5	μA
		$V_{DD} = 10V$		2.0		0.01	2.0		15	μA
		$V_{DD} = 15V$		4.0		0.01	4.0		30	μA
SIGNAL INPUTS AND OUTPUTS										
R_{ON}	"ON" Resistance	$R_L = 10\text{ k}\Omega$ to $(V_{DD} - V_{SS}/2)$ $V_C = V_{DD}, V_{SS}$ to V_{DD}								
		$V_{DD} = 5V$		850		270	1050		1200	Ω
		$V_{DD} = 10V$		330		120	400		520	Ω
		$V_{DD} = 15V$		210		80	240		300	Ω
ΔR_{ON}	Δ "ON" Resistance Between Any 2 of 4 Switches	$R_L = 10\text{ k}\Omega$ to $(V_{DD} - V_{SS}/2)$ $V_{CC} = V_{DD}, V_{IS} = V_{SS}$ to V_{DD}								
		$V_{DD} = 10V$				10				Ω
		$V_{DD} = 15V$				5				Ω
I_{IS}	Input or Output Leakage Switch "OFF"	$V_C = 0$		± 50		± 0.1	± 50		± 200	nA
CONTROL INPUTS										
V_{ILC}	LOW Level Input Voltage	$V_{IS} = V_{SS}$ and V_{DD} $V_{OS} = V_{DD}$ and V_{SS} $I_{IS} = \pm 10\mu A$								
		$V_{DD} = 5V$		1.5		2.25	1.5		1.5	V
		$V_{DD} = 10V$		3.0		4.5	3.0		3.0	V
		$V_{DD} = 15V$		4.0		6.75	4.0		4.0	V
V_{IHC}	HIGH Level Input Voltage	$V_{DD} = 5V$	3.5		3.5	2.75		3.5		V
		$V_{DD} = 10V$ (Note 7)	7.0		7.0	5.5		7.0		V
		$V_{DD} = 15V$	11.0		11.0	8.25		11.0		V
I_{IN}	Input Current	$V_{DD} - V_{SS} = 15V$ $V_{DD} \geq V_{IS} \geq V_{SS}$ $V_{DD} \geq V_C \geq V_{SS}$		± 0.3		$\pm 10^{-9}$	± 0.3		± 1.0	μA

AC Electrical Characteristics (Note 3)						
$T_A = 25^\circ\text{C}$, $t_r = t_f = 20\text{ ns}$ and $V_{SS} = 0\text{V}$ unless otherwise noted						
Symbol	Parameter	Conditions	Min	Typ	Max	Units
t_{PHL} , t_{PLH}	Propagation Delay Time Signal Input to Signal Output	$V_C = V_{DD}$, $C_L = 50\text{ pF}$, (Figure 1)				
		$R_L = 200\text{ k}$		25	55	ns
		$V_{DD} = 5\text{V}$		15	35	ns
		$V_{DD} = 10\text{V}$ $V_{DD} = 15\text{V}$		10	25	ns
t_{PZH} , t_{PZL}	Propagation Delay Time Control Input to Signal Output High Impedance to Logical Level	$R_L = 1.0\text{ k}\Omega$, $C_L = 50\text{ pF}$, (Figure 2, Figure 3)			125	ns
		$V_{DD} = 5\text{V}$			60	ns
		$V_{DD} = 10\text{V}$ $V_{DD} = 15\text{V}$			50	ns
t_{PHZ} , t_{PLZ}	Propagation Delay Time Control Input to Signal Output Logical Level to High Impedance Sine Wave Distortion Frequency Response-Switch "ON" (Frequency at -3 dB)	$R_L = 1.0\text{ k}\Omega$, $C_L = 50\text{ pF}$, (Figure 2, Figure 3)			125	ns
		$V_{DD} = 5\text{V}$			60	ns
		$V_{DD} = 10\text{V}$			50	ns
		$V_{DD} = 15\text{V}$		0.1		%
		$V_C = V_{DD} = 5\text{V}$, $V_{SS} = -5\text{V}$ $R_L = 10\text{ k}\Omega$, $V_{IS} = 5V_{p-p}$, $f = 1\text{ kHz}$, (Figure 4)		40		MHz
	Feedthrough — Switch "OFF" (Frequency at -50 dB) Crosstalk Between Any Two Switches (Frequency at -50 dB) Crosstalk; Control Input to Signal Output Maximum Control Input	$V_{DD} = 5.0\text{V}$, $V_{CC} = V_{SS} = -5.0\text{V}$, $R_L = 1\text{ k}\Omega$, $V_{IS} = 5.0V_{p-p}$, 20 Log_{10} , $V_{OS}/V_{IS} = -50\text{ dB}$, (Figure 4)		1.25		
		$V_{DD} = V_{C(A)} = 5.0\text{V}$; $V_{SS} = V_{C(B)} = 5.0\text{V}$, $R_L = 1\text{ k}\Omega$, $V_{IS(A)} = 5.0V_{p-p}$, 20 Log_{10} , $V_{OS(B)}/V_{IS(A)} = -50\text{ dB}$ (Figure 5)		0.9		MHz
		$V_{DD} = 10\text{V}$, $R_L = 10\text{ k}\Omega$, $R_{IN} = 1.0\text{ k}\Omega$, $V_{CC} = 10\text{V}$ Square Wave, $C_L = 50\text{ pF}$ (Figure 6)		150		mV _{p-p}
		$R_L = 1.0\text{ k}\Omega$, $C_L = 50\text{ pF}$, (Figure 7)		6.0		MHz
		$V_{OS(f)} = \frac{1}{2} V_{OS}(1.0\text{ kHz})$ $V_{DD} = 5.0\text{V}$ $V_{DD} = 10\text{V}$ $V_{DD} = 15\text{V}$		8.0		MHz
				8.5		MHz
C_{IS}	Signal Input Capacitance			8.0		pF
C_{OS}	Signal Output Capacitance	$V_{DD} = 10\text{V}$		8.0		pF
C_{IOS}	Feedthrough Capacitance	$V_C = 0\text{V}$		0.5		pF
C_{IN}	Control Input Capacitance			5.0	7.5	pF
Note 3: AC Parameters are guaranteed by DC correlated testing.						
Note 4: These devices should not be connected to circuits with the power "ON".						
Note 5: In all cases, there is approximately 5 pF of probe and jig capacitance in the output; however, this capacitance is included in C_L wherever it is specified.						
Note 6: V_{IS} is the voltage at the in/out pin and V_{OS} is the voltage at the out/in pin. V_C is the voltage at the control input.						
Note 7: Conditions for V_{IHC} : a) $V_{IS} = V_{DD}$, $I_{OS} = \text{standard B series } I_{OH}$ b) $V_{IS} = 0\text{V}$, $I_{OL} = \text{standard B series } I_{OL}$.						

Typical Performance Characteristics

“ON” Resistance vs Signal Voltage for $T_A = 25^\circ\text{C}$

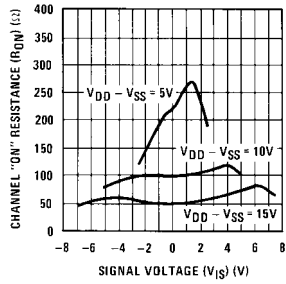

“ON” Resistance as a Function of Temperature for $V_{DD}-V_{SS} = 15\text{V}$

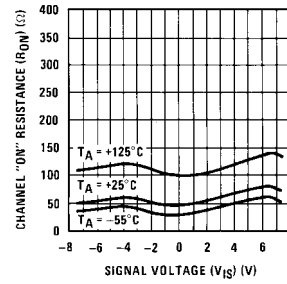

“ON” Resistance as a Function of Temperature for $V_{DD}-V_{SS} = 10\text{V}$

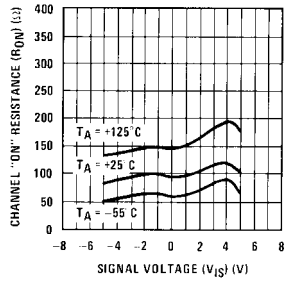

“ON” Resistance as a Function of Temperature for $V_{DD}-V_{SS} = 5\text{V}$

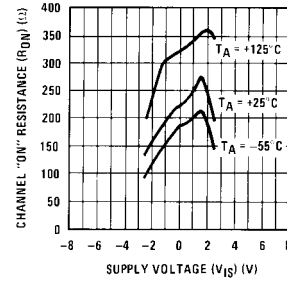

Special Considerations

In applications where separate power sources are used to drive V_{DD} and the signal input, the V_{DD} current capability should exceed V_{DD}/R_L (R_L = effective external load of the 4 CD4066BC bilateral switches). This provision avoids any permanent current flow or clamp action of the V_{DD} supply when power is applied or removed from CD4066BC.

In certain applications, the external load-resistor current may include both V_{DD} and signal-line components. To

avoid drawing V_{DD} current when switch current flows into terminals 1, 4, 8 or 11, the voltage drop across the bidirectional switch must not exceed 0.6V at $T_A \leq 25^\circ\text{C}$, or 0.4V at $T_A > 25^\circ\text{C}$ (calculated from R_{ON} values shown).

No V_{DD} current will flow through R_L if the switch current flows into terminals 2, 3, 9 or 10.

AC Test Circuits and Switching Time Waveforms

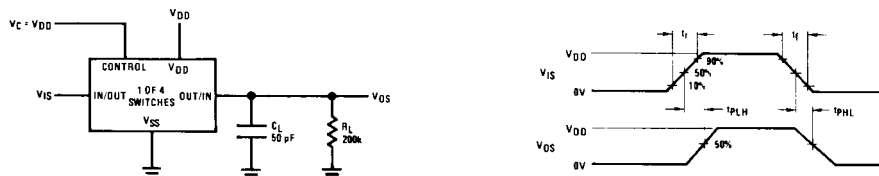

FIGURE 1. t_{PHL} , t_{PLH} Propagation Delay Time Signal Input to Signal Output

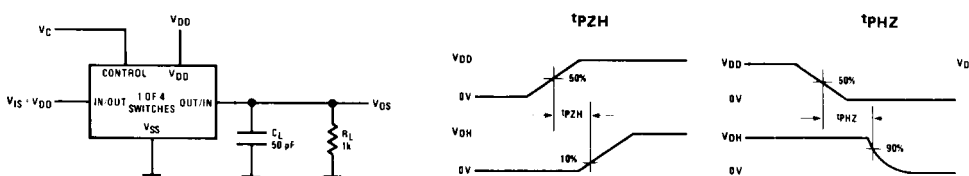

FIGURE 2. t_{PZH} , t_{PHZ} Propagation Delay Time Control to Signal Output

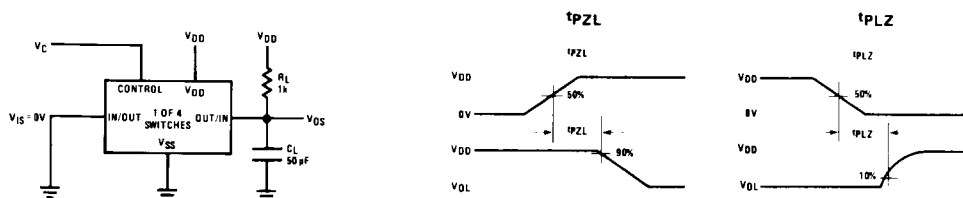
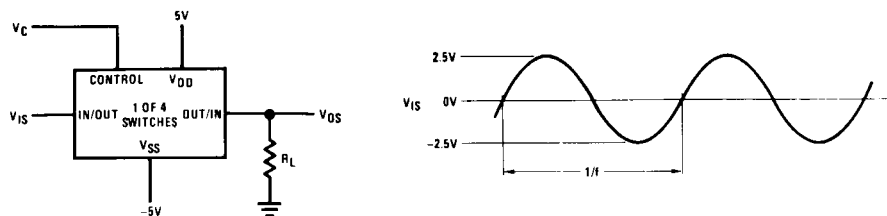

FIGURE 3. t_{PZL} , t_{PLZ} Propagation Delay Time Control to Signal Output



$V_C = V_{DD}$ for distortion and frequency response tests

$V_C = V_{SS}$ for feedthrough test

FIGURE 4. Sine Wave Distortion, Frequency Response and Feedthrough

AC Test Circuits and Switching Time Waveforms (Continued)

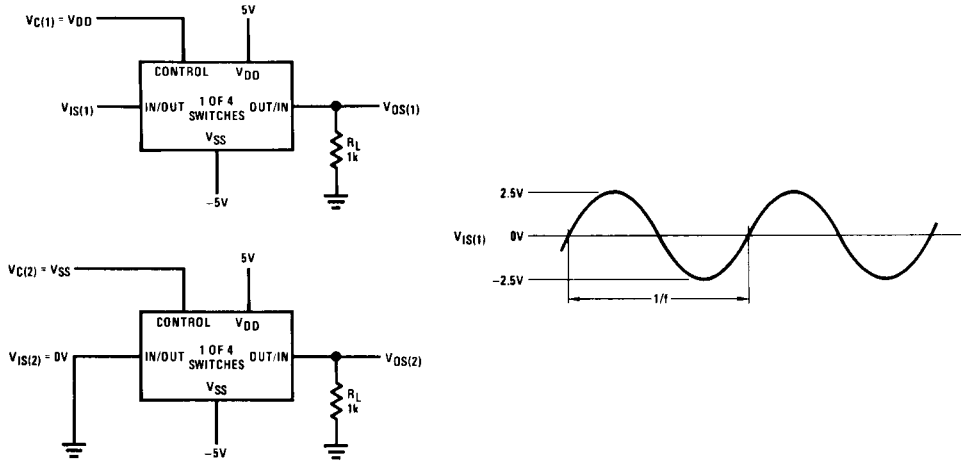

FIGURE 5. Crosstalk Between Any Two Switches

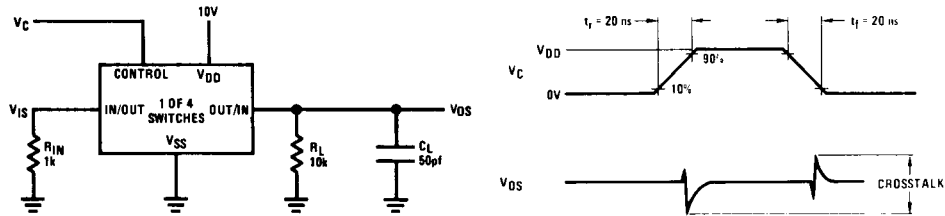

FIGURE 6. Crosstalk: Control Input to Signal Output

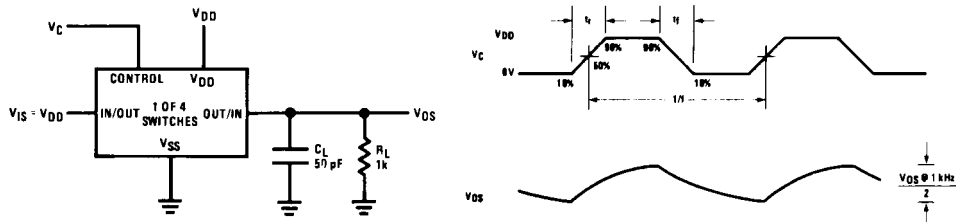
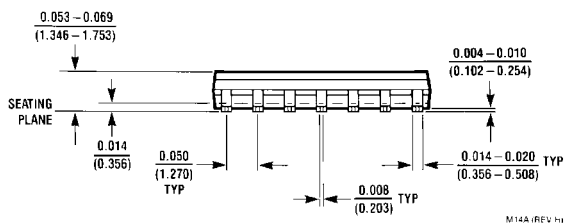
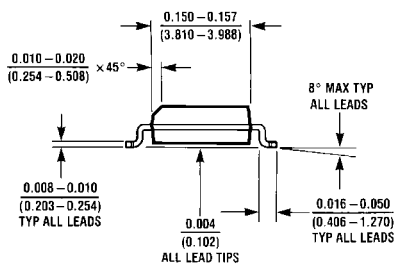
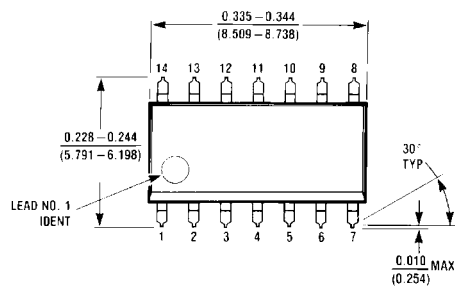

FIGURE 7. Maximum Control Input Frequency

Physical Dimensions inches (millimeters) unless otherwise noted



**14-Lead Small Outline Integrated Circuit (SOIC), JEDEC MS-120, 0.150 Narrow
Package Number M14A**

Physical Dimensions inches (millimeters) unless otherwise noted (Continued)

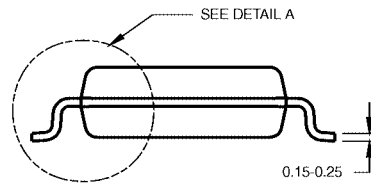
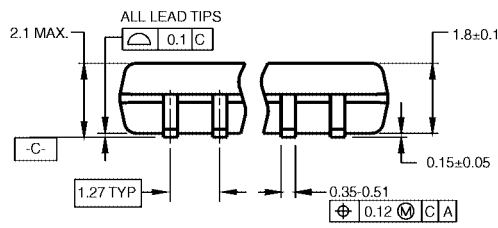
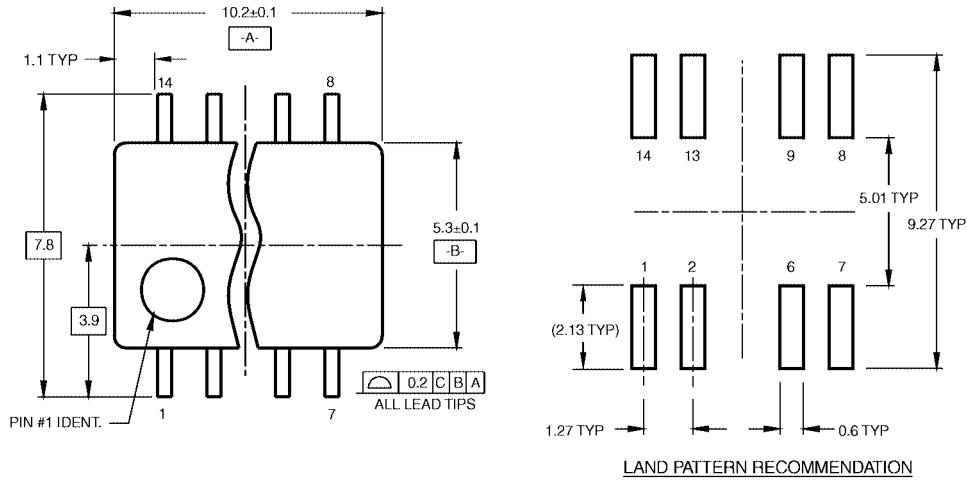

DIMENSIONS ARE IN MILLIMETERS

- NOTES:
 A. CONFORMS TO EIAJ EDR-7320 REGISTRATION, ESTABLISHED IN DECEMBER, 1998.
 B. DIMENSIONS ARE IN MILLIMETERS.
 C. DIMENSIONS ARE EXCLUSIVE OF BURRS, MOLD FLASH, AND TIE BAR EXTRUSIONS.

M14DRevB1

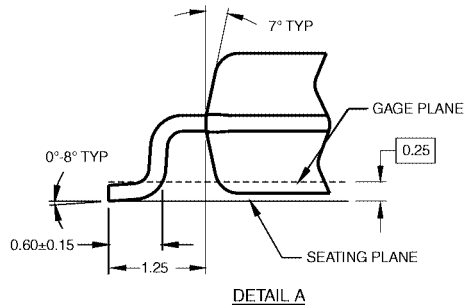

**14-Lead Small Outline Package (SOP), EIAJ TYPE II, 5.3mm Wide
 Package Number M14D**

Physical Dimensions inches (millimeters) unless otherwise noted (Continued)

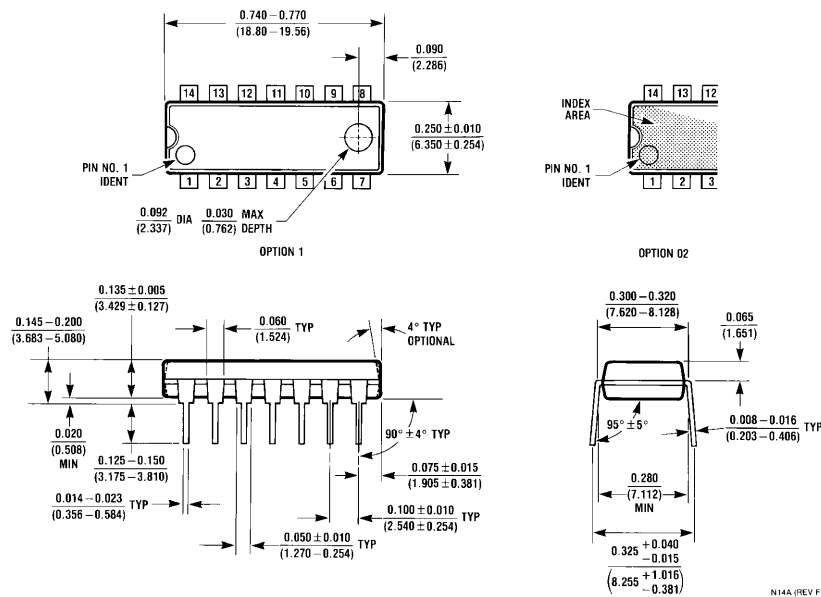

14-Lead Plastic Dual-In-Line Package (PDIP), JEDEC MS-001, 0.300 Wide Package Number N14A

Fairchild does not assume any responsibility for use of any circuitry described, no circuit patent licenses are implied and Fairchild reserves the right at any time without notice to change said circuitry and specifications.

LIFE SUPPORT POLICY

FAIRCHILD'S PRODUCTS ARE NOT AUTHORIZED FOR USE AS CRITICAL COMPONENTS IN LIFE SUPPORT DEVICES OR SYSTEMS WITHOUT THE EXPRESS WRITTEN APPROVAL OF THE PRESIDENT OF FAIRCHILD SEMICONDUCTOR CORPORATION. As used herein:

1. Life support devices or systems are devices or systems which, (a) are intended for surgical implant into the body, or (b) support or sustain life, and (c) whose failure to perform when properly used in accordance with instructions for use provided in the labeling, can be reasonably expected to result in a significant injury to the user.
2. A critical component in any component of a life support device or system whose failure to perform can be reasonably expected to cause the failure of the life support device or system, or to affect its safety or effectiveness.

www.fairchildsemi.com