

Distributed by:

JAMECO[®]
ELECTRONICS

www.Jameco.com ♦ 1-800-831-4242

The content and copyrights of the attached
material are the property of its owner.

Jameco Part Number 1392894



TIMEKEEPER® SNAPHAT® (BATTERY & CRYSTAL)

FEATURES SUMMARY

- PROVIDES BATTERY BACKUP POWER FOR NON-VOLATILE TIMEKEEPER® and SUPERVISOR DEVICES IN THE 28- OR 44-PIN SNAPHAT SOIC PACKAGE
- REMOVABLE BATTERY AVOIDS HEAT ASSOCIATED WITH SURFACE MOUNT PROCESS
- SNAPS DIRECTLY ONTO SURFACE-MOUNTED SNAPHAT SOIC
- CHOICE OF BATTERY CAPACITIES:
 - M4T28-BR12SH = 48mAh
 - M4T32-BR12SH = 120mAh
- KEYED INSERTION TO INSURE PROPER ASSEMBLY
- REMOVABLE FOR REPLACEMENT and PROPER DISPOSAL
- Pb-FREE PACKAGE
- AVAILABLE IN TUBES OR TAPE & REEL

Figure 1. SNAPHAT Top Package

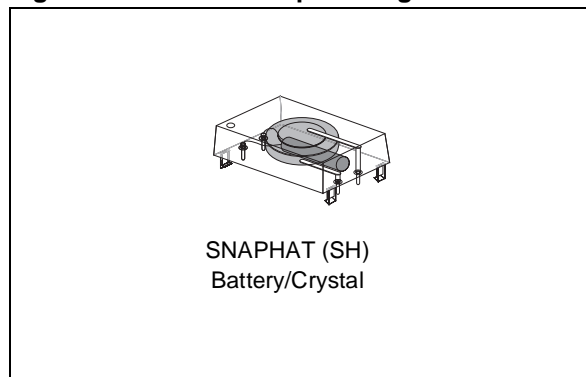

TABLE OF CONTENTS

SUMMARY DESCRIPTION **3**
 Logic Diagram (Figure 2.) 3
 Signal Names (Table 1.) 3

MAXIMUM RATING **4**
 Absolute Maximum Ratings (Table 2.) 4

DC AND AC PARAMETERS **4**
 Operating and AC Measurement Conditions (Table 3.) 4

MECHANICAL INFORMATION **5**
 SNAPHAT Insertion/Extraction Forces (Figure 3.) 5
 Battery Characteristics **6**
 UL Recognition **6**
 Battery Life **6**
 General Notes **6**
 Battery Discharge Rates (Figure 4.) 7
 DIP Extractor Tool (Figure 5.) 7

PART NUMBERING **8**

PACKAGE MECHANICAL INFORMATION **9**

REVISION HISTORY **11**

SUMMARY DESCRIPTION

The M4TXX-BR12SH SNAPHAT[®] top is a detachable lithium power source for ST's non-volatile TIMEKEEPER[®] surface-mount SOIC (MH) package (28- and 44-pin).

The SNAPHAT top contains both the battery and crystal and is designed to be "snapped on" after the SOIC is surface mounted on the PC board. Thus the two piece solution prevents the battery and crystal from being exposed to the high temperatures of the surface mount process.

Figure 2. Logic Diagram

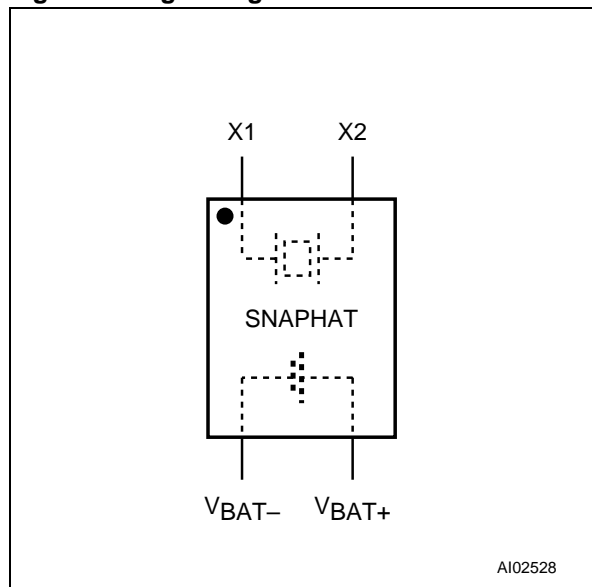

Table 1. Signal Names

X1	Crystal Input
X2	Crystal Output
V _{BAT-}	Negative Voltage
V _{BAT+}	Positive Voltage

MAXIMUM RATING

Stressing the device above the rating listed in the “Absolute Maximum Ratings” table may cause permanent damage to the device. These are stress ratings only and operation of the device at these or any other conditions above those indicated in the Operating sections of this specification is

not implied. Exposure to Absolute Maximum Rating conditions for extended periods may affect device reliability. Refer also to the STMicroelectronics SURE Program and other relevant quality documents.

Table 2. Absolute Maximum Ratings

Symbol	Parameter	Value	Unit	
T _A	Ambient Operating Temperature	Grade 1	0 to 70	°C
		Grade 6 ⁽¹⁾	-40 to 85	°C
T _{STG}	Storage Temperature (V _{CC} Off, Oscillator Off)	-40 to 85	°C	

Note: 1. Only the M4T32-BR12SH is available in Industrial temperature (Grade 6).

CAUTION: Do NOT wave solder SOIC to avoid damaging SNAPHAT sockets.

DC AND AC PARAMETERS

This section summarizes the operating and measurement conditions, as well as the DC and AC characteristics of the device. The parameters in the following DC and AC Characteristic tables are derived from tests performed under the Measure-

ment Conditions listed in the relevant tables. Designers should check that the operating conditions in their projects match the measurement conditions when using the quoted parameters.

Table 3. Operating and AC Measurement Conditions

Parameter	M4T28-BR12SH	M4T32-BR12SH	Unit
Nominal Battery Voltage (V _{CC})	2.8	2.8	V
Nominal Battery Capacity	48	120	mAh
Battery Chemistry	Li(CF)	Li(CF)	
Crystal Load Capacitance (C _L)	12.5	12.5	pF
Nominal Crystal Frequency	32.768	32.768	kHz
Crystal Accuracy (@ 25°C)	± 35	± 35	ppm

MECHANICAL INFORMATION

Electrical connection to the SOIC is made through four pins that connect to the four press fitted sockets at each end of the SOIC. Critical contact points between the pins and sockets are gold-plated to resist oxidation. Internally, each socket contains six independent contact fingers to form redundant connections between the two components. These sockets were designed with high point contact force to provide the lowest possible contact resistance. The SNAPHAT[®] top also incorporates four molded-in retaining clips which hold onto the ends of the SOIC insuring mechanical and electrical connection even under severe mechanical shock and vibration. The combined SOIC and SNAPHAT

assembly can sustain shock levels in excess of 100 g without separating. This package also passes variable frequency testing in accordance with MIL-STD-883, method 2007.2, condition A.

Figure 3 illustrates the affect of repeated insertion and extraction of the SNAPHAT top to the SOIC. The force required to extract the SNAPHAT, and then to re-insert it, reduces each time. After four or five extractions, the reduction starts to become unnoticeable and the force required remains at a fairly constant figure. Typically, though, the SNAPHAT will only need to be extracted and re-inserted once in its lifetime.

Figure 3. SNAPHAT Insertion/Extraction Forces

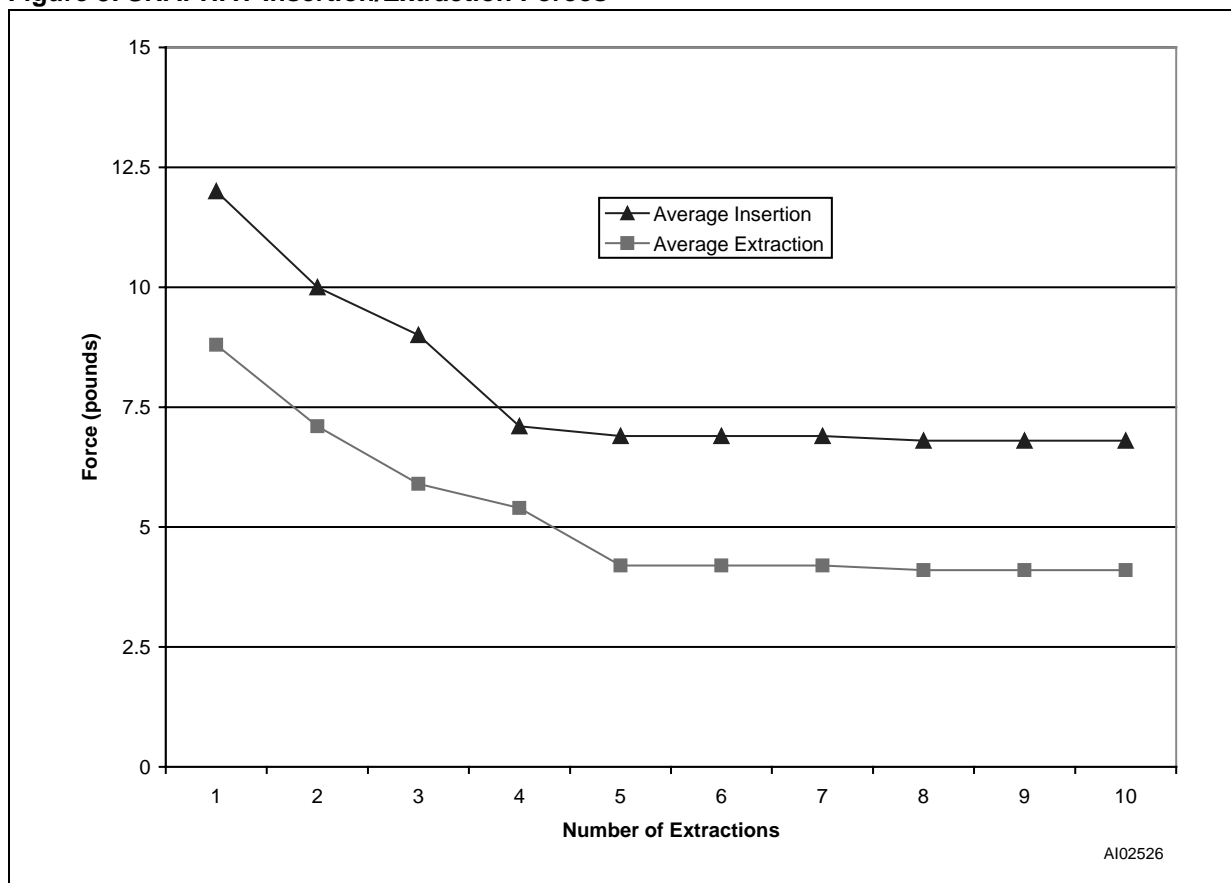

Battery Characteristics

Figure 4, page 7 illustrates the lithium coin cell discharge rate for a given load. This demonstrates the characteristically flat voltage level supplied by the battery until very near the end of its life. These discharge levels have been greatly accelerated in comparison to the normal, actual usage.

Note: These batteries contain no Mercury (Hg), Cadmium (Cd), or Lead (Pb).

UL Recognition

The M4Txx-BR12SH has been recognized by Underwriters Laboratories under their Component Recognition Program and carries U.L. File Number E89556.

Battery Life

For information on Data Retention Life and Battery Storage Life, please refer to the Application Note AN1012.

General Notes

ST has conducted experiments using a manual press which determined that if approximately 60

pounds of force is applied to the top of the SNAPHAT[®], battery damage and/or die cracks could be induced. As Figure 3, page 5 specifies, only an average of less than 13 force-pounds is required for proper insertion. We recommend that no more than 40 pounds of force be applied during SNAPHAT insertion.

If a manual press is employed, it is very important that it be calibrated such that it cannot exceed this limit.

To remove the SNAPHAT top for replacement, a DIP/IC extractor tool should be used (see Figure 5). The SNAPHAT top should be grabbed by the narrow end to avoid bending the pins.

Caution: To avoid draining battery do NOT place SNAPHAT pins into conductive foam.

Caution: To avoid damaging SNAPHAT sockets do NOT wave solder SOIC.

For battery disposal information, see on the web at www.rayovac.com.

Figure 4. Battery Discharge Rates

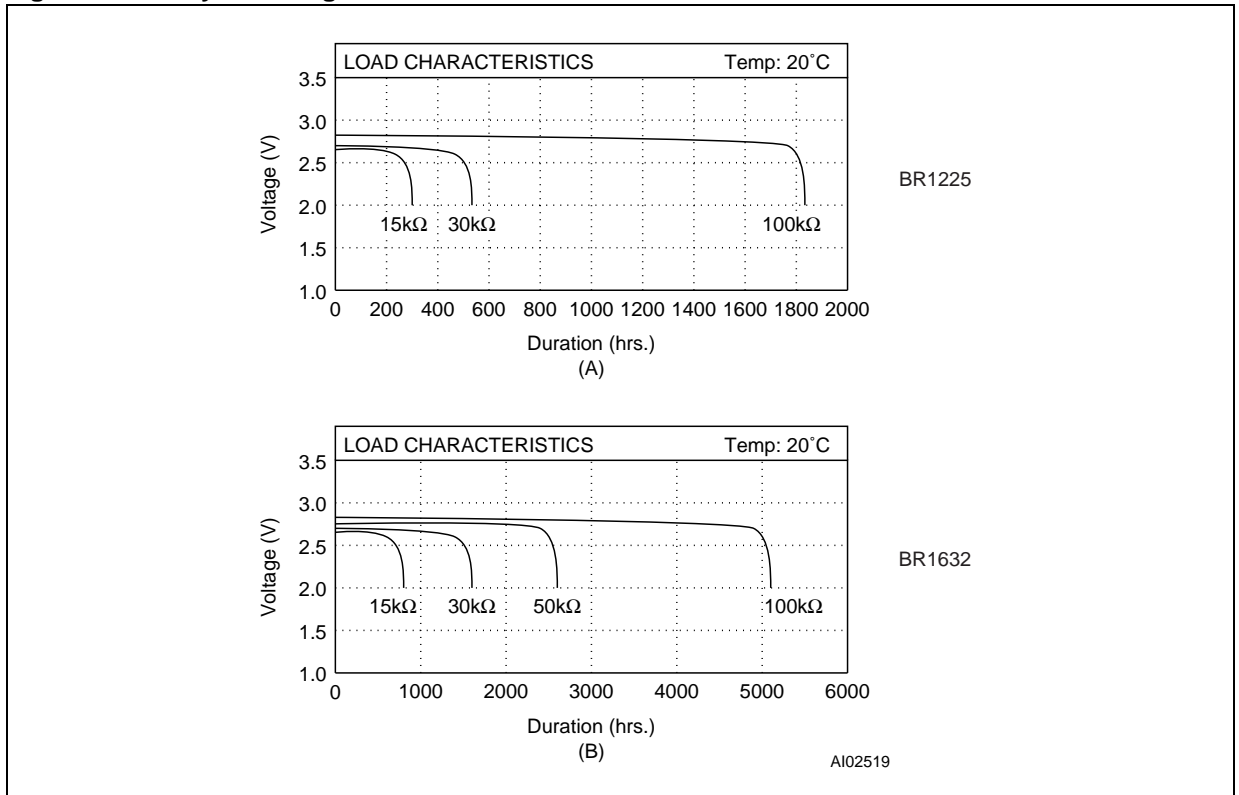
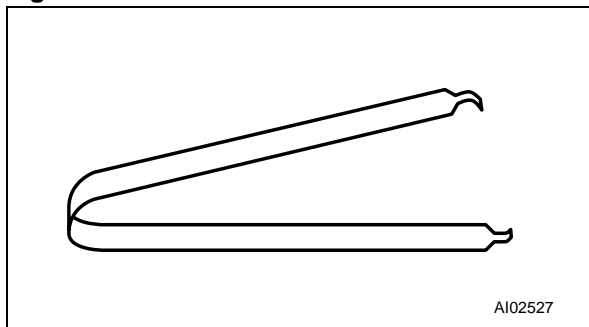

Figure 5. DIP Extractor Tool



PART NUMBERING

Table 4. Ordering Information Scheme

Example:	M4T	28-BR12	SH	1	TR
Device Type					
M4T					
Battery Voltage and Capacity					
28-BR12 = BR1225, 3V, 48mAh					
32-BR12 = BR1632, 3V, 120mAh					
Package					
SH = SNAPHAT®					
Temperature Range					
1 = 0 to 70°C					
6 = -40 to 85°C (M4T32-BR12SH only)					
Shipping Method					
blank = Tubes					
TR = Tape & Reel					

For a list of available options (e.g., Speed, Package) or for further information on any aspect of this device, please contact the ST Sales Office nearest to you.

PACKAGE MECHANICAL INFORMATION

Figure 6. SH – 4-pin SNAPHAT Housing for 48mAh Battery & Crystal, Package Outline

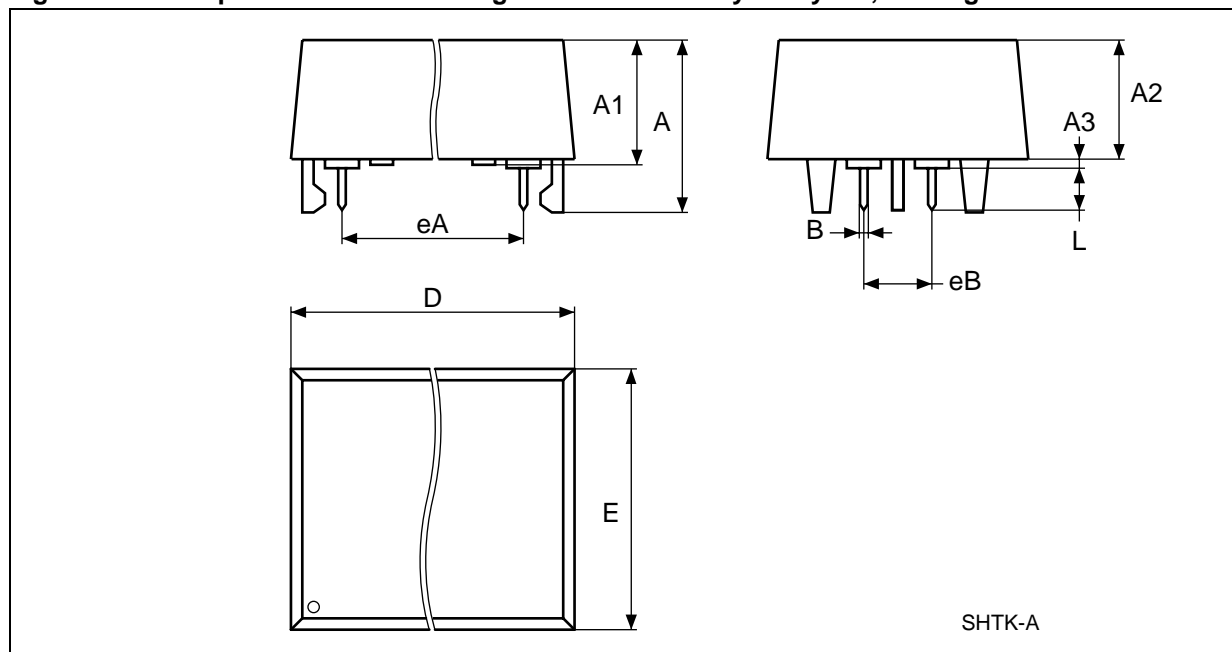

Note: Drawing is not to scale.

Table 5. SH – 4-pin SNAPHAT Housing for 48mAh Battery & Crystal, Package Mechanical Data

Symb	mm			inches		
	Typ	Min	Max	Typ	Min	Max
A			9.78			0.385
A1		6.73	7.24		0.265	0.285
A2		6.48	6.99		0.255	0.275
A3			0.38			0.015
B		0.46	0.56		0.018	0.022
D		21.21	21.84		0.835	0.860
E		14.22	14.99		0.560	0.590
eA		15.55	15.95		0.612	0.628
eB		3.20	3.61		0.126	0.142
L		2.03	2.29		0.080	0.090

Figure 7. SH – 4-pin SNAPHAT Housing for 120mAh Battery & Crystal, Package Outline

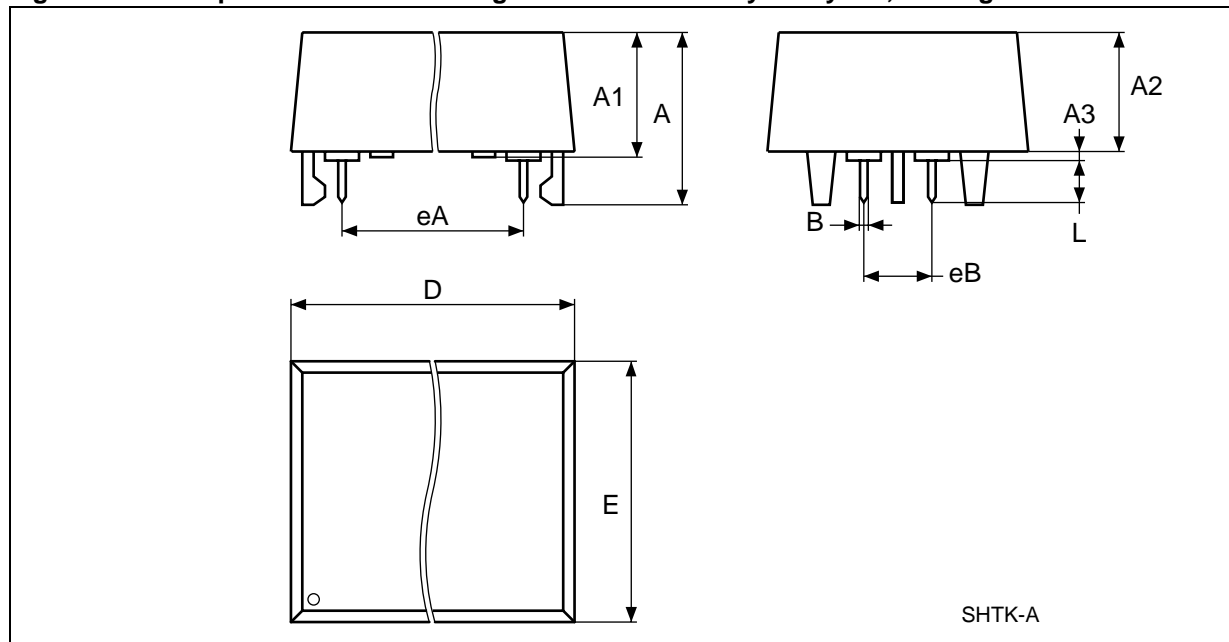

Note: Drawing is not to scale.

Table 6. SH – 4-pin SNAPHAT Housing for 120mAh Battery & Crystal, Package Mechanical Data

Symb	mm			inches		
	Typ	Min	Max	Typ	Min	Max
A			10.54			0.415
A1		8.00	8.51		0.315	0.335
A2		7.24	8.00		0.285	0.315
A3			0.38			0.015
B		0.46	0.56		0.018	0.022
D		21.21	21.84		0.835	0.860
E		17.27	18.03		0.680	0.710
eA		15.55	15.95		0.612	0.628
eB		3.20	3.61		0.126	0.142
L		2.03	2.29		0.080	0.090

REVISION HISTORY**Table 7. Document Revision History**

Date	Rev. #	Revision Details
November 1999	1.0	First Issue
01-Mar-01	2.0	Reformatted
04-Jun-01	2.1	Basic textual changes from reformatting activity
10-Jul-01	2.2	Changes references to "SUPERVISOR" from "Controller;" clarify temperature characteristics
21-Jan-02	2.3	Change to include Crystal Accuracy (Table 3); add text for SNAPHAT insertion force tolerance and battery characteristics note
20-Aug-02	2.4	Updated Insertion/Extraction Data (Figure 3)
14-Mar-03	2.5	Add Pb-free note on page 1

Information furnished is believed to be accurate and reliable. However, STMicroelectronics assumes no responsibility for the consequences of use of such information nor for any infringement of patents or other rights of third parties which may result from its use. No license is granted by implication or otherwise under any patent or patent rights of STMicroelectronics. Specifications mentioned in this publication are subject to change without notice. This publication supersedes and replaces all information previously supplied. STMicroelectronics products are not authorized for use as critical components in life support devices or systems without express written approval of STMicroelectronics.

The ST logo is registered trademark of STMicroelectronics
All other names are the property of their respective owners.

© 2003 STMicroelectronics - All Rights Reserved

STMicroelectronics GROUP OF COMPANIES

Australia - Brazil - Canada - China - Finland - France - Germany - Hong Kong - India - Israel - Italy - Japan - Malaysia -
Malta - Morocco - Singapore - Spain - Sweden - Switzerland - United Kingdom - U.S.A.

www.st.com