

## ERD SERIES

### 10x10 SIZE SEALED CONSTRUCTION ROTARY TYPE

PIN OUT (3:3)



ERD 1xxxx  
(Flat Type)



ERD 2xxxx  
(Shaft Type)

PIN OUT(1:4)



ERD 4xxxx  
(Flat Type)



ERD 5xxxx  
(Shaft Type)

## FEATURES

- Molded-in terminals and fully sealed construction.
- Standard 2.54mm pin spacing.
- All plastics UL 94V-0 grade fire retardant.
- Reliable contact and long-term stability.
- Binary decimal (8 or 10 positions) and hexadecimal (16 positions), real and complementary codes available.
- Pin-out compatible with most of current equivalents.
- Gold plated contacts to ensure low contact resistance.

## SPECIFICATIONS

### 1.ELECTRICAL

● Contact rating	
switching	25mA, 24VDC
non-switching	100mA
● Contact resistance	100m Max.
● Insulation resistance	1000M Min. at 100VDC
● Dielectric strength	250VAC Min. for 60seconds

## 2.MECHANICAL AND ENVIRONMENTAL

● Temperature rating	
operating	-25 to +70
Storage	-40 to +85
● Operation force	500 gf-cm Max.
● Mechanical life	2000 steps per position
● Vibration	10Hz-50Hz-10Hz for 6 Hrs
● Solderability (for through hole type)	after flux 230±5 for 5±0.5 seconds,95 % coverage
● Resistance to soldering heat (for through hole type)	260±5 for 5±1 seconds.
● Reflow soldering heat for SMT type(reference only)	210 for 20 seconds or less, peak temperature 230 or less

### PART NUMBERING SYSTEM

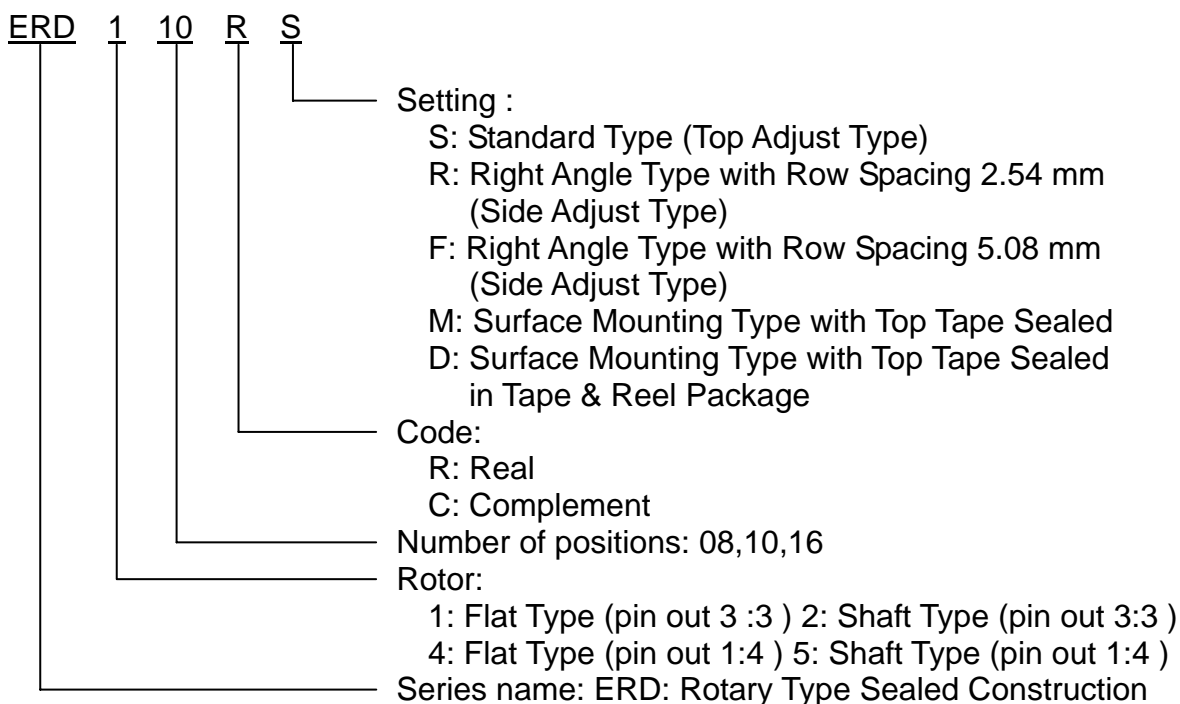

### CODE

PIN NO.	POSITIONS															
	0	1	2	3	4	5	6	7	8	9	A	B	C	D	E	F
1																
2																
4																
8																

... Real Code

Rotor color:

White (3:3), Yellow (1:4)

... Complement Code

Rotor color:

Red (3:3), Orange (1:4)

## CONSTRUCTION

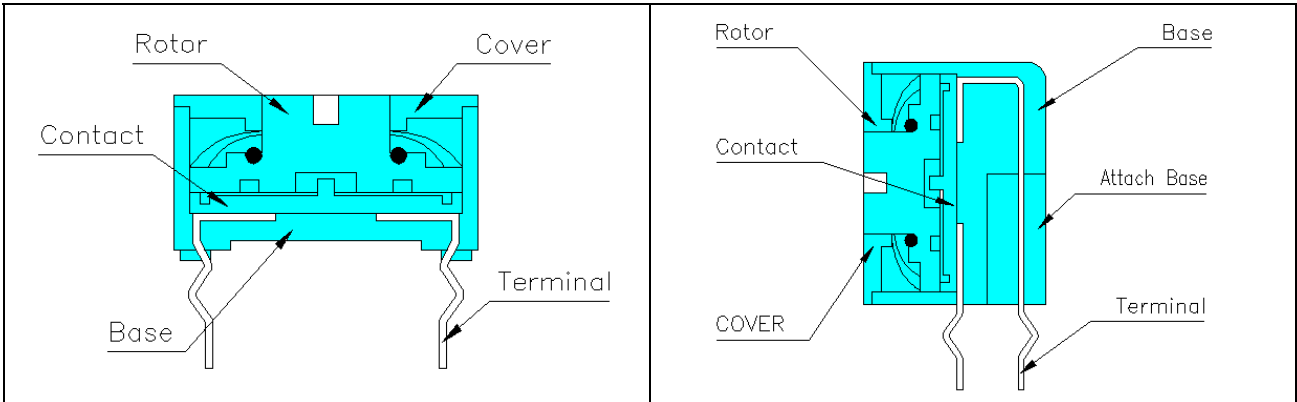

## OPTIONS

1. Special marking available upon request
2. Shaft Cover
  - 418-80100(White 3:3)
  - 418-80200(Red 3:3)
  - 418-80300(Yellow 1:4)
  - 418-80400(Orange 1:4)

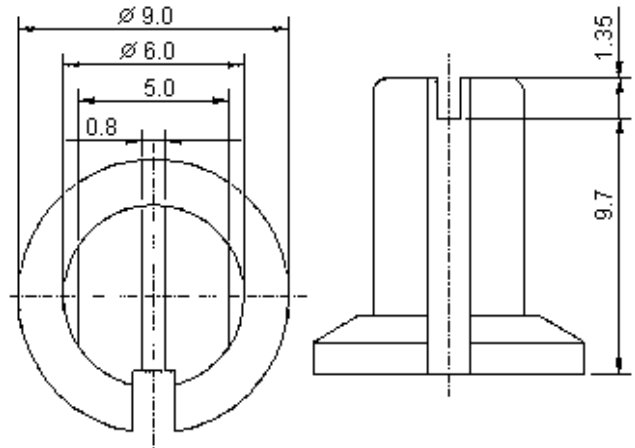

## 3. Tape & Reel Packaging (Per EIA STANDARD)

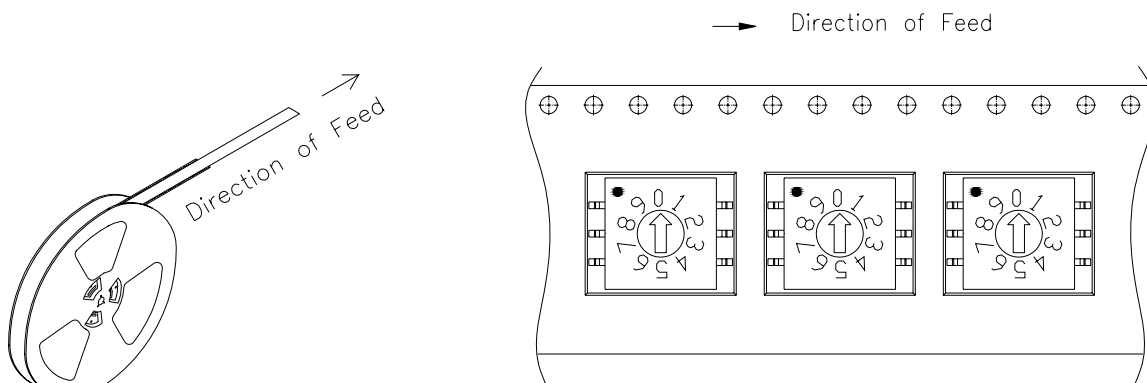

Each Reel contains 700 pcs switches with a 390mm minimum leader and a 160mm minimum trailer

## INTRODUCTION to ECE ROTARY DIP SWITCH

SIZE	POSITIONS	CODE	PIN OUT	ROTOR	TYPE	PART NUMBER
10x10	8,10,16	REAL, COMPLEMENT	3:3	FLAT, SHAFT	STANDARD	ERD1xxxS,ERD2xxxS
					RIGHT ANGLE	ERD1xxxR/F,ERD2xxR/F
				FLAT	SMT	ERD1xxxM
					SMT IN T&R	ERD1xxxD
			1:4	FLAT, SHAFT	STANDARD	ERD4xxxS,ERD5xxxS
					RIGHT ANGLE	ERD4xxxR/F,ERD5xxxR/F
				FLAT	SMT	ERD4xxxM
					SMT IN T&R	ERD4xxxD

## DIMENSIONS AND CIRCUITRY UNIT:mm(inch) **PIN OUT 3:3**

### ERD1xxxS Flat Type

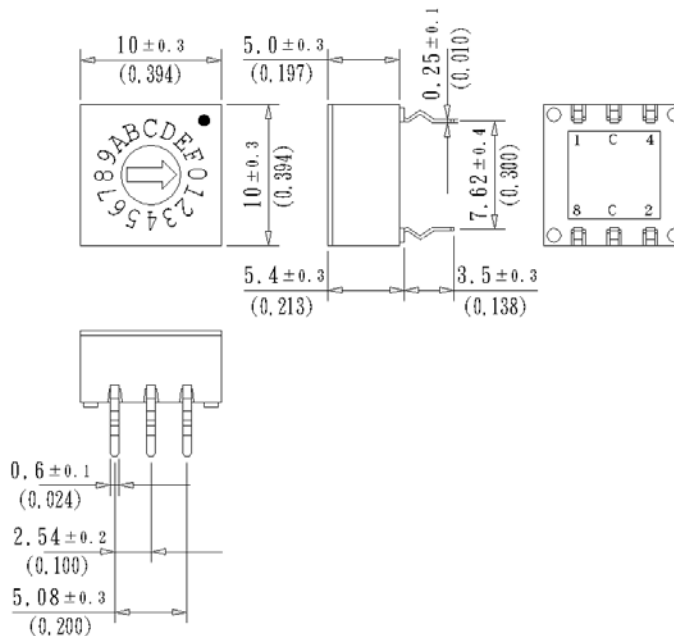

## ERD2xxxS Shaft Type

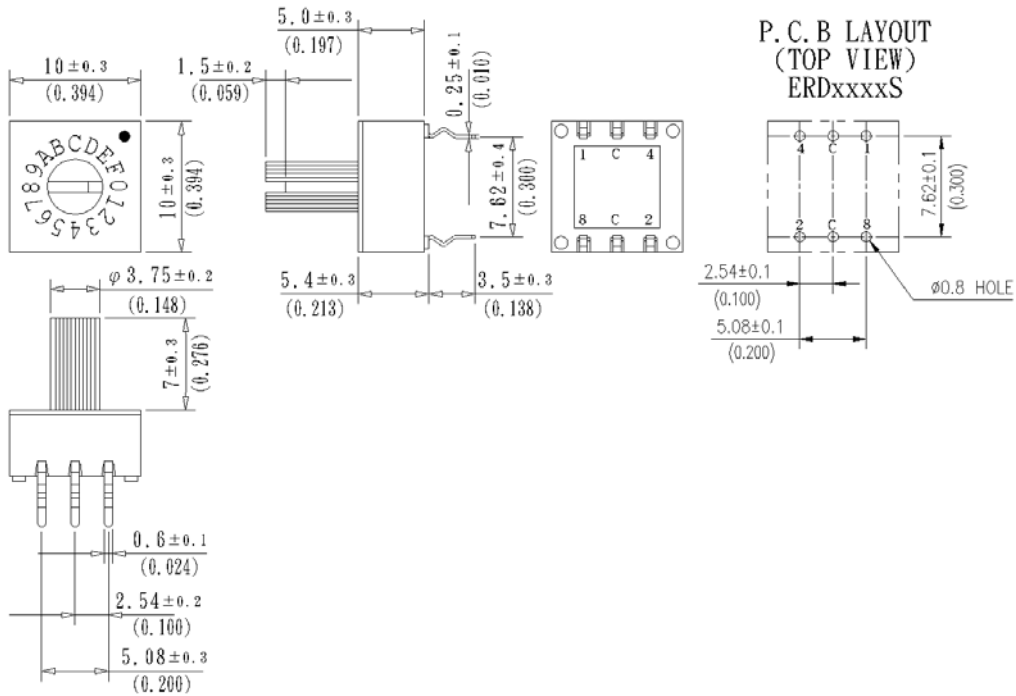

## ERD1xxxR Flat Type

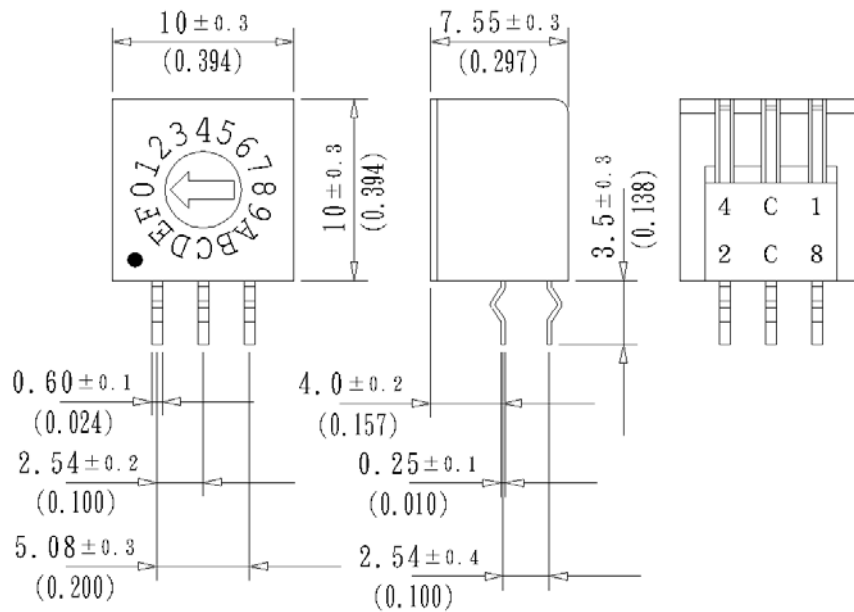

## ERD2xxxR Shaft Type

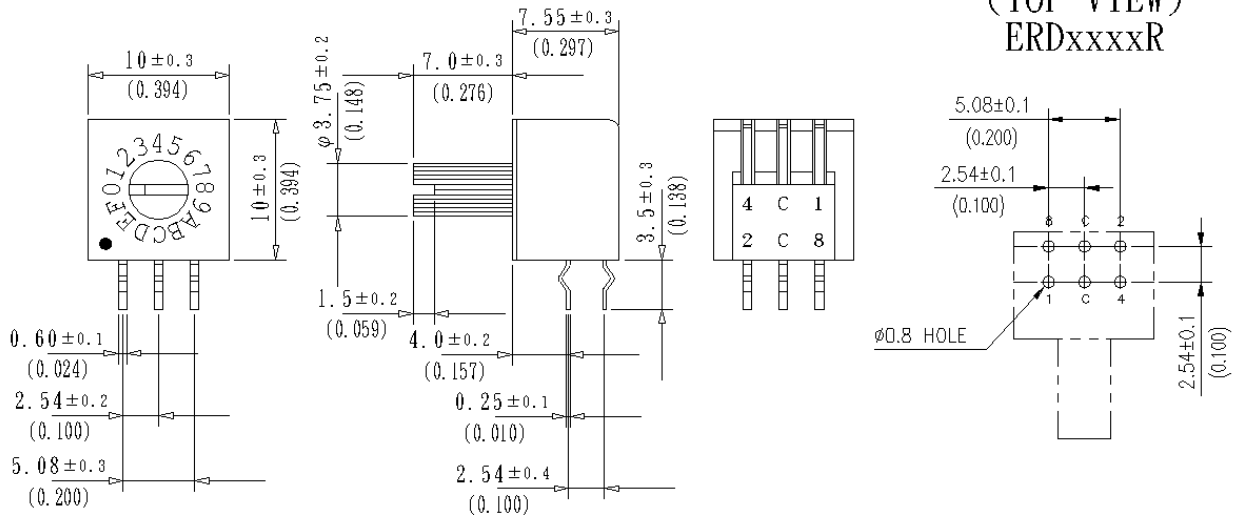

## ERD1xxxF Flat Type

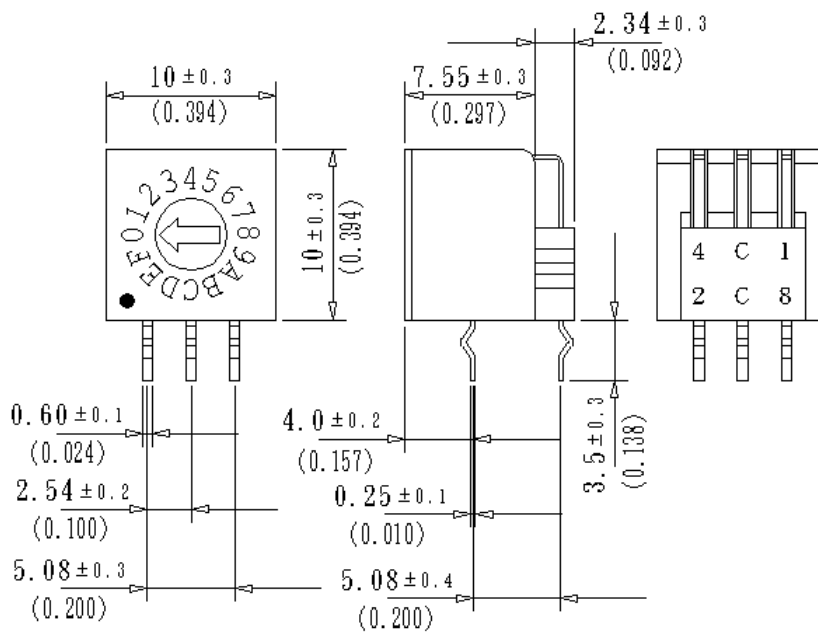

## ERD2xxxF Shaft Type

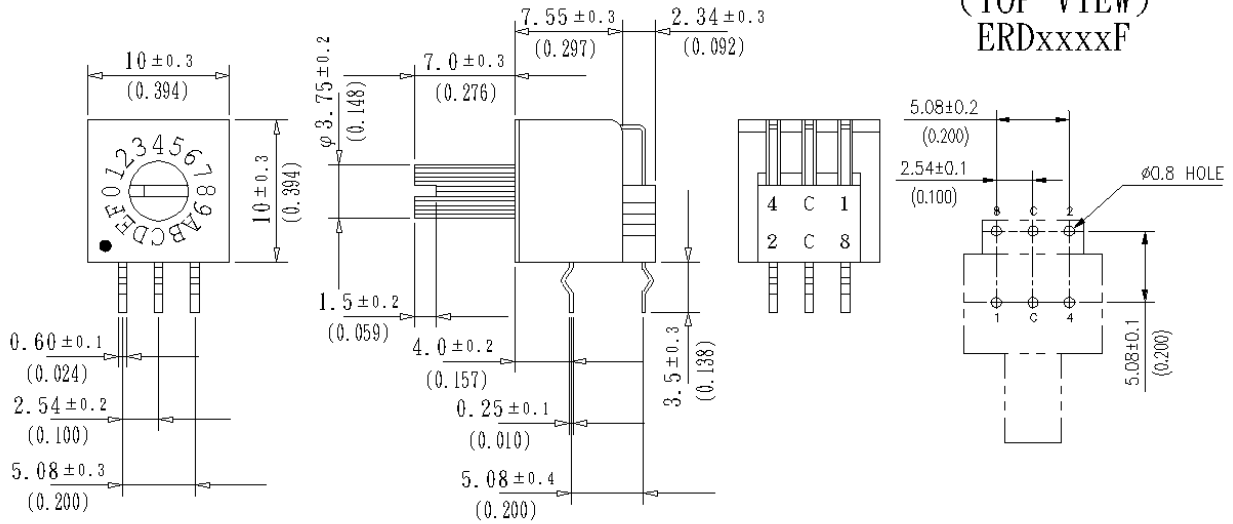

## ERD1xxxM Flat Type

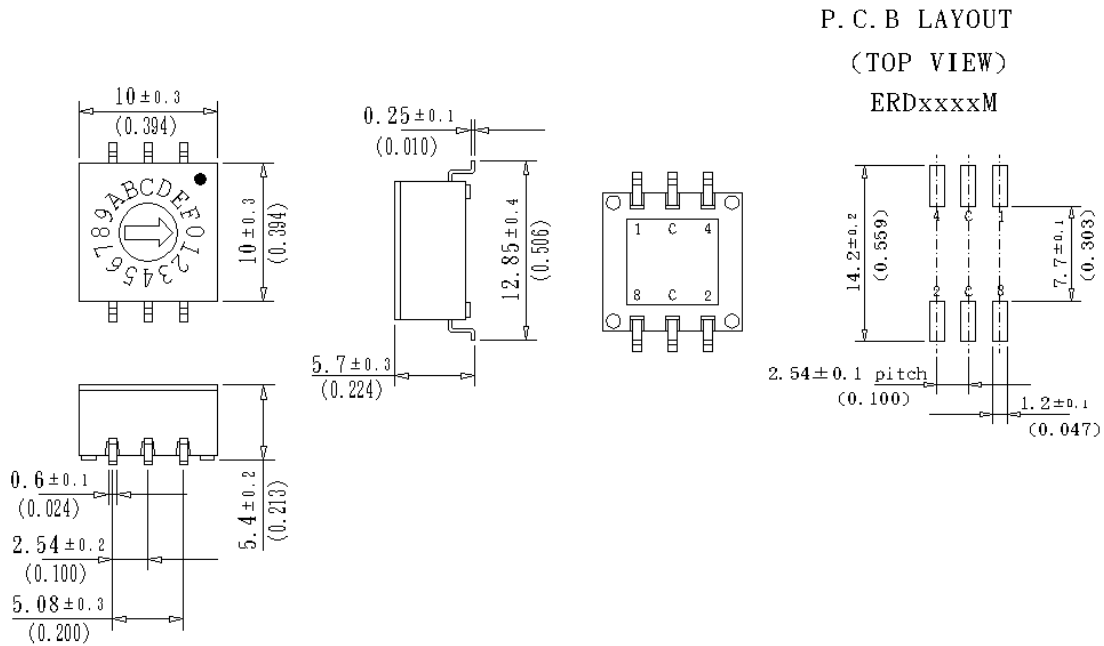

**DIMENSIONS AND CIRCUITRY UNIT:mm(inch) PIN OUT 1:4**

ERD4xxxS Flat Type

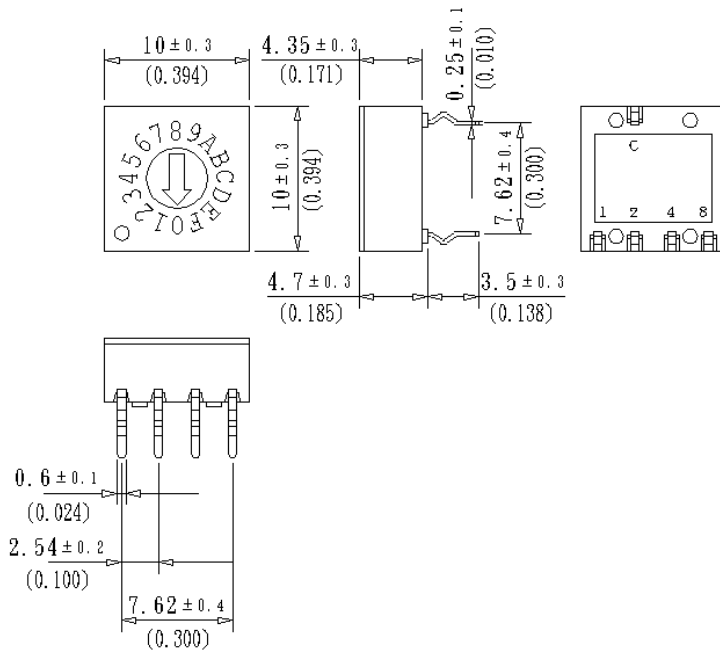

ERD5xxxS Shaft Type

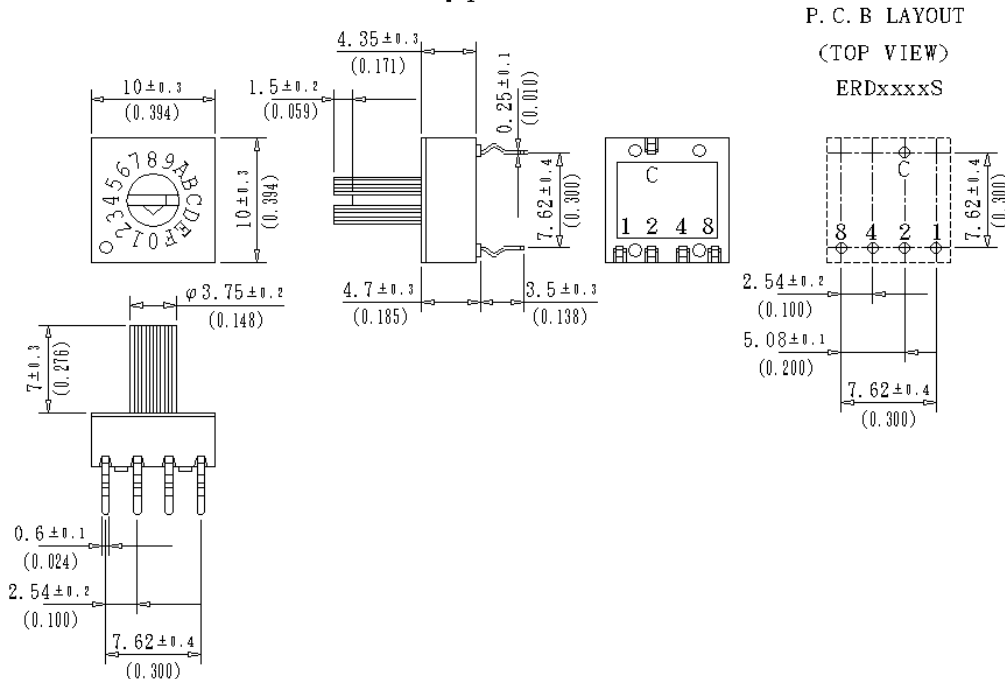







## ERD4xxxM Flat Type

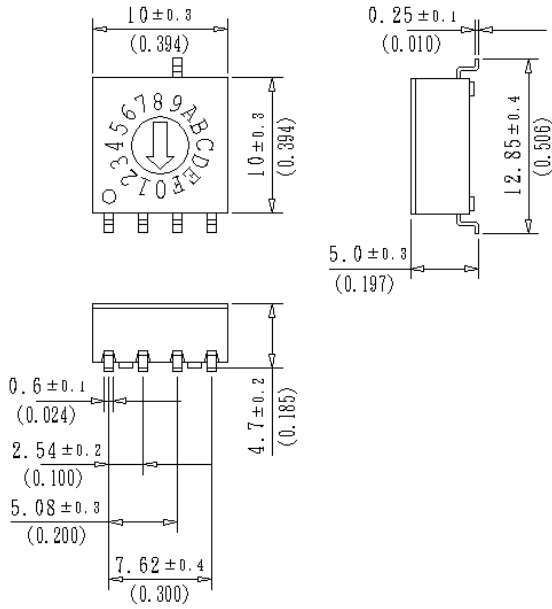

## P. C. B LAYOUT

(TOP VIEW)  
ERDxxxxM

