

Distributed by:



[www.Jameco.com](http://www.Jameco.com) ♦ 1-800-831-4242

The content and copyrights of the attached material are the property of its owner.

# 2N6071A/B Series

Preferred Device

## Sensitive Gate Triacs

### Silicon Bidirectional Thyristors

Designed primarily for full-wave ac control applications, such as light dimmers, motor controls, heating controls and power supplies; or wherever full-wave silicon gate controlled solid-state devices are needed. Triac type thyristors switch from a blocking to a conducting state for either polarity of applied anode voltage with positive or negative gate triggering.

- Sensitive Gate Triggering Uniquely Compatible for Direct Coupling to TTL, HTL, CMOS and Operational Amplifier Integrated Circuit Logic Functions
- Gate Triggering 4 Mode — 2N6071A,B, 2N6073A,B, 2N6075A,B
- Blocking Voltages to 600 Volts
- All Diffused and Glass Passivated Junctions for Greater Parameter Uniformity and Stability
- Small, Rugged, Thermopad Construction for Low Thermal Resistance, High Heat Dissipation and Durability
- Device Marking: Device Type, e.g., 2N6071A, Date Code

**MAXIMUM RATINGS** ( $T_J = 25^\circ\text{C}$  unless otherwise noted)

Rating	Symbol	Value	Unit
*Peak Repetitive Off-State Voltage <sup>(1)</sup> ( $T_J = -40$ to $110^\circ\text{C}$ , Sine Wave, 50 to 60 Hz, Gate Open)	$V_{DRM}$ , $V_{RRM}$	200 400 600	Volts
*On-State RMS Current ( $T_C = 85^\circ\text{C}$ ) Full Cycle Sine Wave 50 to 60 Hz	$I_T(\text{RMS})$	4.0	Amps
*Peak Non-repetitive Surge Current (One Full cycle, 60 Hz, $T_J = +110^\circ\text{C}$ )	$I_{TSM}$	30	Amps
Circuit Fusing Considerations ( $t = 8.3$ ms)	$I^2t$	3.7	$\text{A}^2\text{s}$
*Peak Gate Power (Pulse Width $\leq 1.0$ $\mu\text{s}$ , $T_C = 85^\circ\text{C}$ )	$P_{GM}$	10	Watts
*Average Gate Power ( $t = 8.3$ ms, $T_C = 85^\circ\text{C}$ )	$P_{G(AV)}$	0.5	Watt
*Peak Gate Voltage (Pulse Width $\leq 1.0$ $\mu\text{s}$ , $T_C = 85^\circ\text{C}$ )	$V_{GM}$	5.0	Volts
*Operating Junction Temperature Range	$T_J$	$-40$ to $+110$	$^\circ\text{C}$
*Storage Temperature Range	$T_{stg}$	$-40$ to $+150$	$^\circ\text{C}$
Mounting Torque (6-32 Screw) <sup>(2)</sup>	—	8.0	in. lb.

\*Indicates JEDEC Registered Data.

(1)  $V_{DRM}$  and  $V_{RRM}$  for all types can be applied on a continuous basis. Blocking voltages shall not be tested with a constant current source such that the voltage ratings of the devices are exceeded.

(2) Torque rating applies with use of a compression washer. Mounting torque in excess of 6 in. lb. does not appreciably lower case-to-sink thermal resistance. Main terminal 2 and heatsink contact pad are common.



ON Semiconductor

<http://onsemi.com>

**TRIACS**  
**4 AMPERES RMS**  
**200 thru 600 VOLTS**

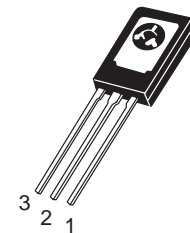
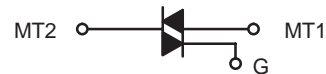

**TO-225AA**  
(formerly TO-126)  
**CASE 077**  
**STYLE 5**

#### PIN ASSIGNMENT

1	Main Terminal 1
2	Main Terminal 2
3	Gate

#### ORDERING INFORMATION

Device	Package	Shipping
2N6071A	TO225AA	500/Box
2N6071B	TO225AA	500/Box
2N6073A	TO225AA	500/Box
2N6073B	TO225AA	500/Box
2N6075A	TO225AA	500/Box
2N6075B	TO225AA	500/Box

**Preferred** devices are recommended choices for future use and best overall value.

## 2N6071A/B Series

### THEMAL CHARACTERISTICS

Characteristic	Symbol	Max	Unit
*Thermal Resistance, Junction to Case	$R_{\theta JC}$	3.5	$^{\circ}C/W$
Thermal Resistance, Junction to Ambient	$R_{\theta JA}$	75	$^{\circ}C/W$
Maximum Lead Temperature for Soldering Purposes 1/8" from Case for 10 Seconds	$T_L$	260	$^{\circ}C$

### ELECTRICAL CHARACTERISTICS ( $T_C = 25^{\circ}C$ unless otherwise noted; Electricals apply in both directions)

Characteristic	Symbol	Min	Typ	Max	Unit
----------------	--------	-----	-----	-----	------

### OFF CHARACTERISTICS

*Peak Repetitive Blocking Current ( $V_D = \text{Rated } V_{DRM}, V_{RRM}, \text{ Gate Open}$ )	$I_{DRM}, I_{RRM}$	—	—	10	$\mu A$
$T_J = 25^{\circ}C$		—	—	2	mA
$T_J = 110^{\circ}C$		—	—		

### ON CHARACTERISTICS

*Peak On-State Voltage <sup>(1)</sup> ( $I_{TM} = \pm 6 \text{ A Peak}$ )	$V_{TM}$	—	—	2	Volts	
*Gate Trigger Voltage (Continuous dc) (Main Terminal Voltage = 12 Vdc, $R_L = 100 \text{ Ohms}$ , $T_J = -40^{\circ}C$ ) All Quadrants	$V_{GT}$	—	1.4	2.5	Volts	
Gate Non-Trigger Voltage (Main Terminal Voltage = 12 Vdc, $R_L = 100 \text{ Ohms}$ , $T_J = 110^{\circ}C$ ) All Quadrants	$V_{GD}$	0.2	—	—	Volts	
*Holding Current (Main Terminal Voltage = 12 Vdc, Gate Open, Initiating Current = $\pm 1 \text{ Adc}$ )	$I_H$	—	—	30	mA	
$(T_J = -40^{\circ}C)$		—	—	15		
$(T_J = 25^{\circ}C)$						
Turn-On Time ( $I_{TM} = 14 \text{ Adc}, I_{GT} = 100 \text{ mAdc}$ )	$t_{gt}$	—	1.5	—	$\mu s$	
			<b>QUADRANT (Maximum Value)</b>			
Gate Trigger Current (Continuous dc) (Main Terminal Voltage = 12 Vdc, $R_L = 100 \text{ ohms}$ )	<b>Type</b>	<b><math>I_{GT}</math> @ <math>T_J</math></b>	<b>I mA</b>	<b>II mA</b>	<b>III mA</b>	<b>IV mA</b>
	2N6071A	+25 $^{\circ}C$	5	5	5	10
	2N6073A	-40 $^{\circ}C$	20	20	20	30
	2N6075A					
	2N6071B	+25 $^{\circ}C$	3	3	3	5
2N6073B	-40 $^{\circ}C$	15	15	15	20	
2N6075B						

### DYNAMIC CHARACTERISTICS

Critical Rate of Rise of Commutation Voltage @ $V_{DRM}, T_J = 85^{\circ}C$ , Gate Open, $I_{TM} = 5.7 \text{ A}$ , Exponential Waveform, Commutating $di/dt = 2.0 \text{ A/ms}$	$dv/dt(c)$	—	5	—	$V/\mu s$
--	------------	---	---	---	-----------

\*Indicates JEDEC Registered Data.

(1) Pulse Test: Pulse Width  $\leq 2.0 \text{ ms}$ , Duty Cycle  $\leq 2\%$ .

## 2N6071A/B Series

### SAMPLE APPLICATION: TTL-SENSITIVE GATE 4 AMPERE TRIAC TRIGGERS IN MODES II AND III

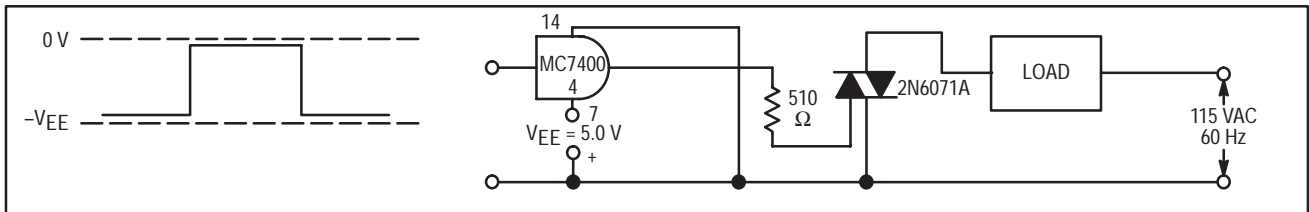

Trigger devices are recommended for gating on Triacs. They provide:

1. Consistent predictable turn-on points.
2. Simplified circuitry.
3. Fast turn-on time for cooler, more efficient and reliable operation.

### Voltage Current Characteristic of Triacs (Bidirectional Device)

Symbol	Parameter
$V_{DRM}$	Peak Repetitive Forward Off State Voltage
$I_{DRM}$	Peak Forward Blocking Current
$V_{RRM}$	Peak Repetitive Reverse Off State Voltage
$I_{RRM}$	Peak Reverse Blocking Current
$V_{TM}$	Maximum On State Voltage
$I_H$	Holding Current

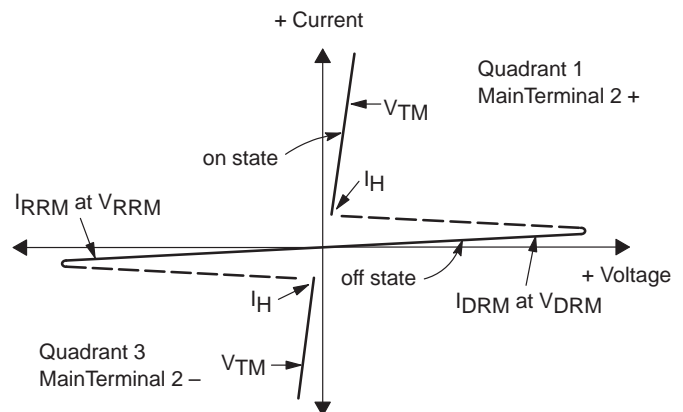

## 2N6071A/B Series

### Quadrant Definitions for a Triac

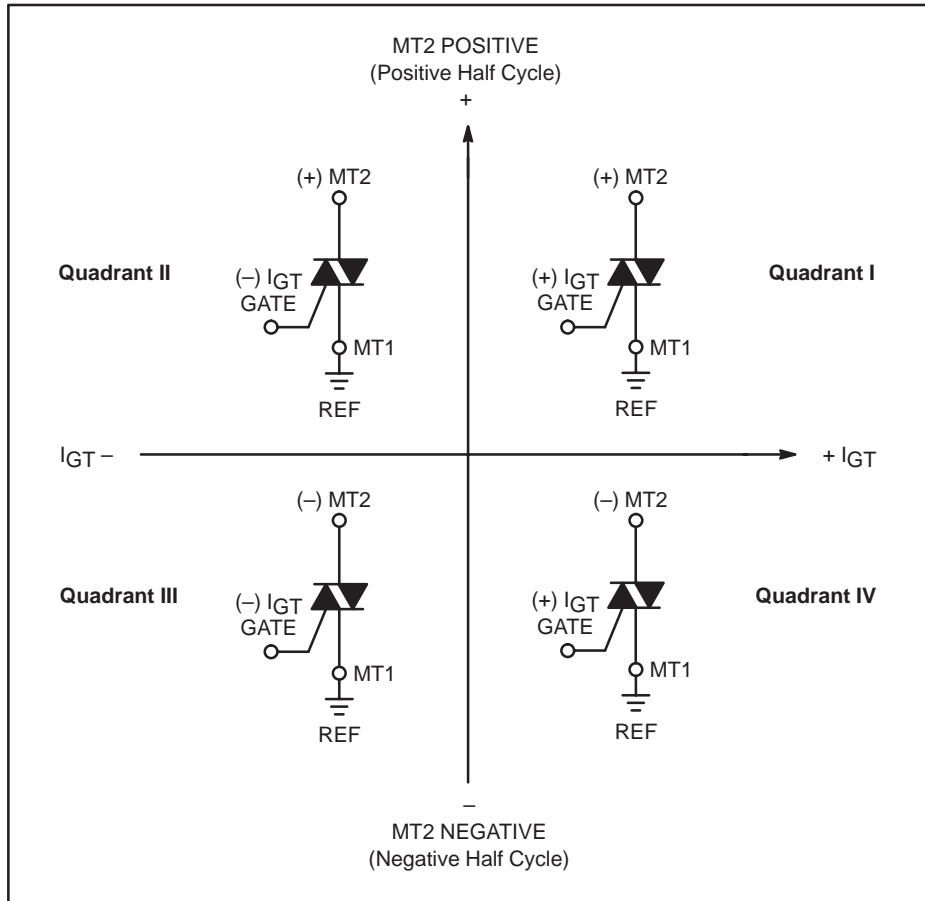

All polarities are referenced to MT1.

With in-phase signals (using standard AC lines) quadrants I and III are used.

### SENSITIVE GATE LOGIC REFERENCE

IC Logic Functions	Firing Quadrant			
	I	II	III	IV
TTL		2N6071A Series	2N6071A Series	
HTL		2N6071A Series	2N6071A Series	
CMOS (NAND)	2N6071B Series			2N6071B Series
CMOS (Buffer)		2N6071B Series	2N6071B Series	
Operational Amplifier	2N6071A Series			2N6071A Series
Zero Voltage Switch		2N6071A Series	2N6071A Series	

## 2N6071A/B Series

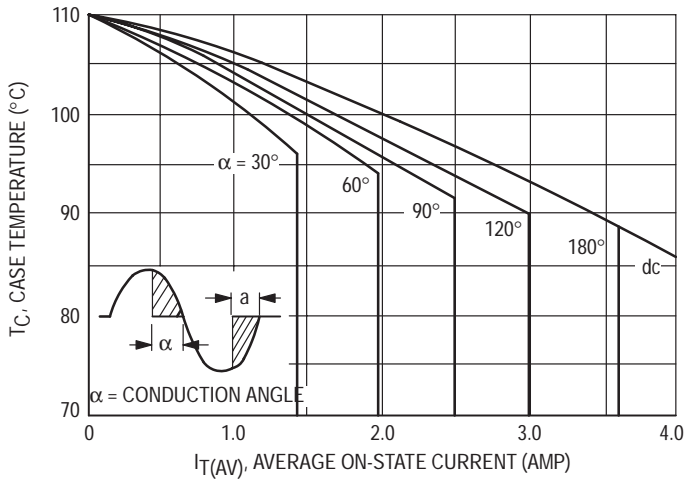

**Figure 1. Average Current Derating**

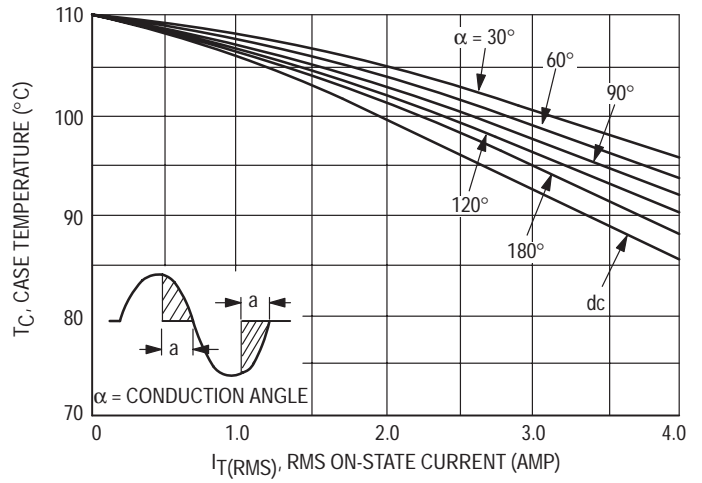

**Figure 2. RMS Current Derating**

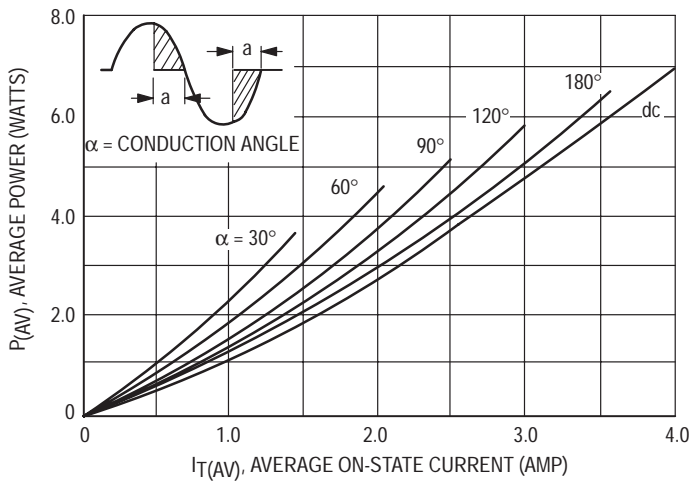

**Figure 3. Power Dissipation**

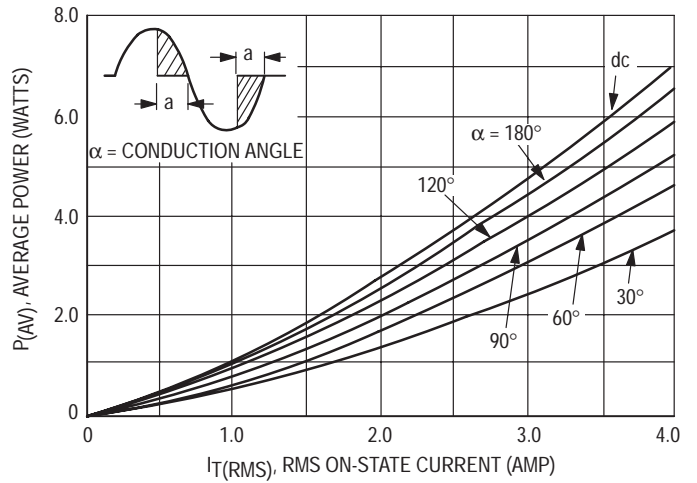

**Figure 4. Power Dissipation**

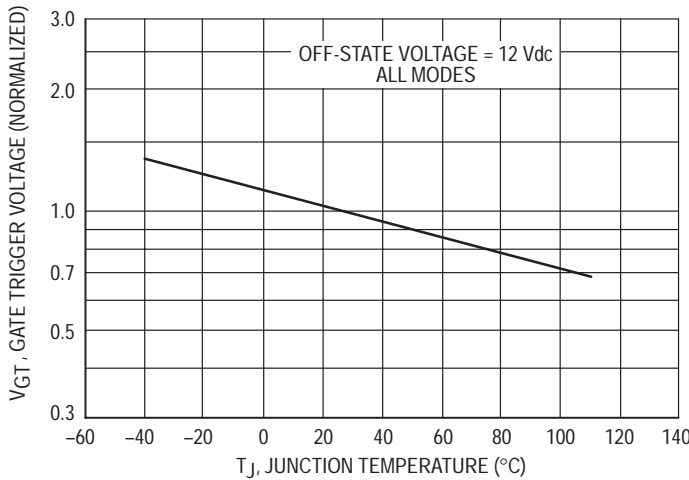

**Figure 5. Typical Gate-Trigger Voltage**

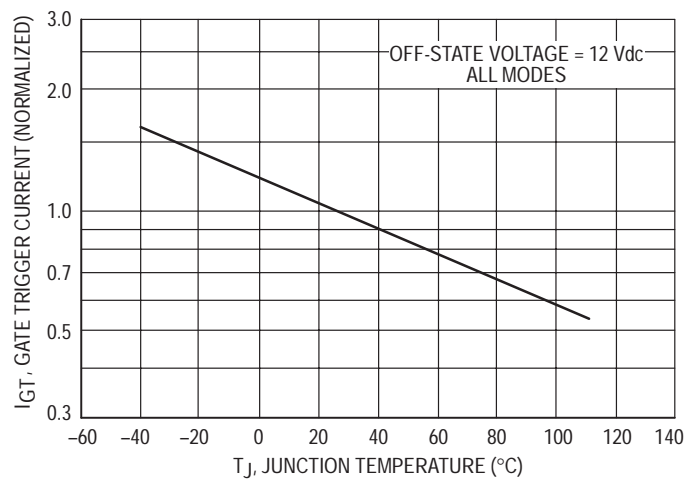

**Figure 6. Typical Gate-Trigger Current**

# 2N6071A/B Series

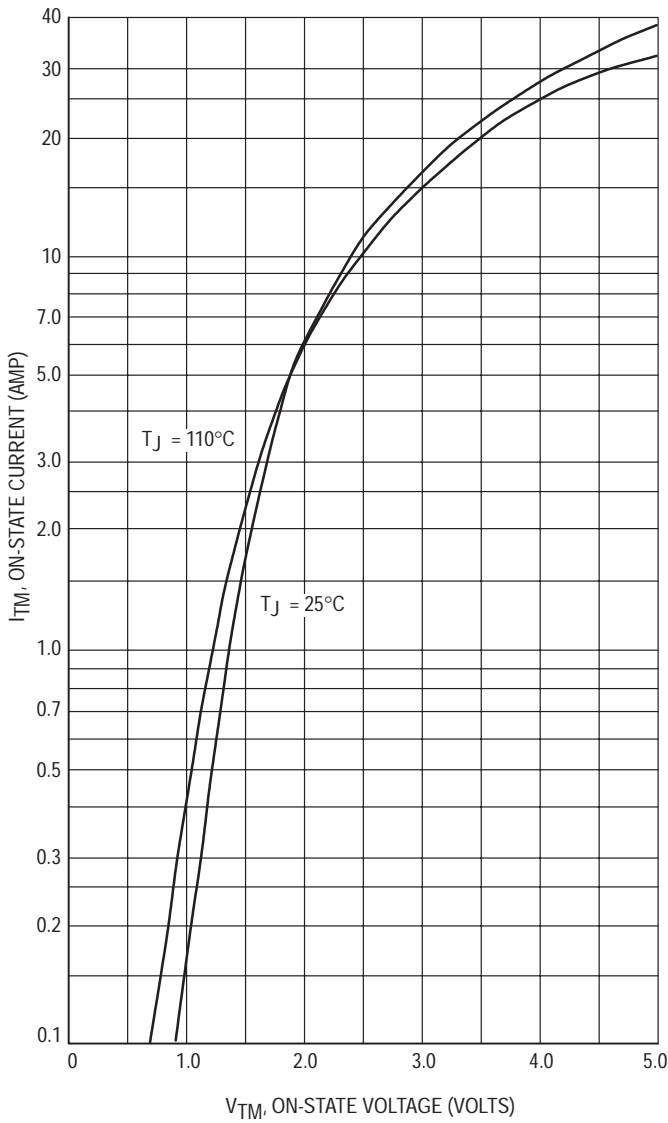

Figure 7. Maximum On-State Characteristics

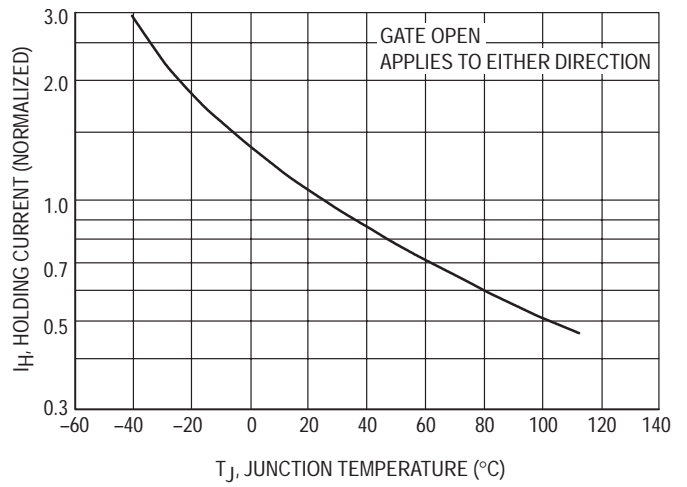

Figure 8. Typical Holding Current

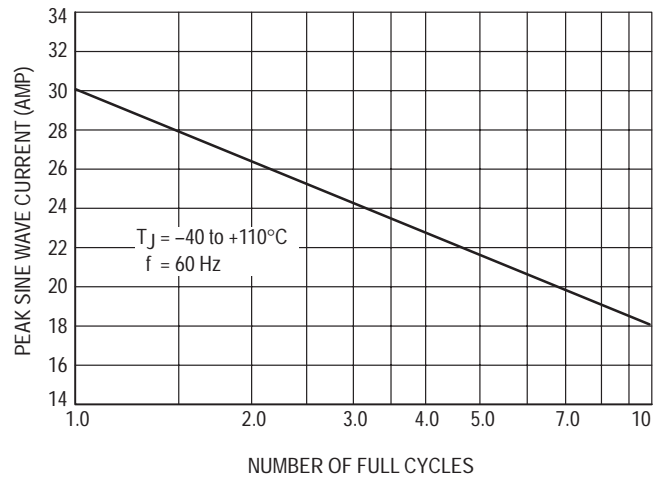

Figure 9. Maximum Allowable Surge Current

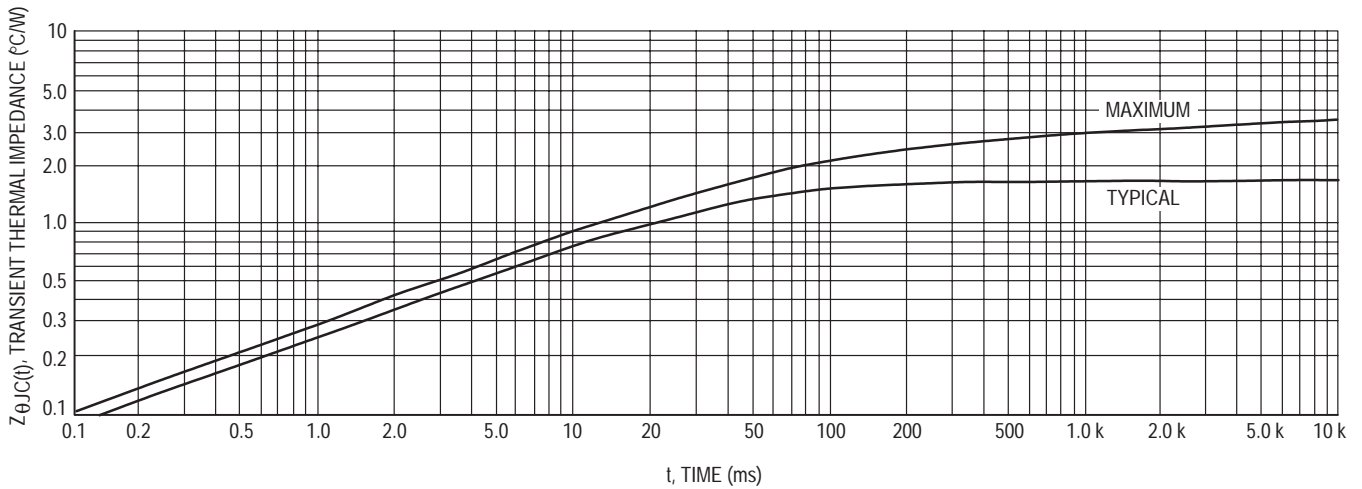
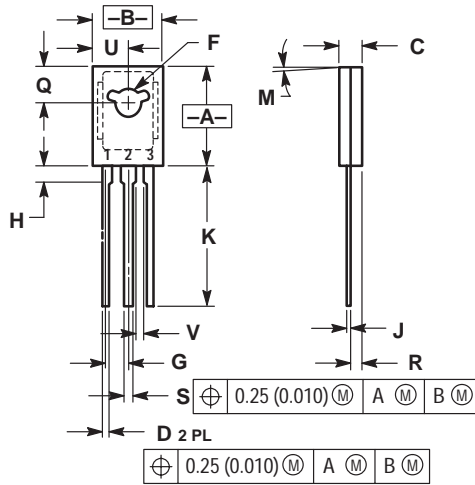

Figure 10. Thermal Response

# 2N6071A/B Series

## PACKAGE DIMENSIONS

TO-225AA  
(formerly TO-126)  
CASE 077-09  
ISSUE W



- NOTES:
1. DIMENSIONING AND TOLERANCING PER ANSI Y14.5M, 1982.
  2. CONTROLLING DIMENSION: INCH.

DIM	INCHES		MILLIMETERS	
	MIN	MAX	MIN	MAX
A	0.425	0.435	10.80	11.04
B	0.295	0.305	7.50	7.74
C	0.095	0.105	2.42	2.66
D	0.020	0.026	0.51	0.66
F	0.115	0.130	2.93	3.30
G	0.094 BSC		2.39 BSC	
H	0.050	0.095	1.27	2.41
J	0.015	0.025	0.39	0.63
K	0.575	0.655	14.61	16.63
M	5° TYP		5° TYP	
Q	0.148	0.158	3.76	4.01
R	0.045	0.065	1.15	1.65
S	0.025	0.035	0.64	0.88
U	0.145	0.155	3.69	3.93
V	0.040	—	1.02	—

- STYLE 5:  
PIN 1. MT 1  
2. MT 2  
3. GATE



## 2N6071A/B Series

**ON Semiconductor** and  are trademarks of Semiconductor Components Industries, LLC (SCILLC). SCILLC reserves the right to make changes without further notice to any products herein. SCILLC makes no warranty, representation or guarantee regarding the suitability of its products for any particular purpose, nor does SCILLC assume any liability arising out of the application or use of any product or circuit, and specifically disclaims any and all liability, including without limitation special, consequential or incidental damages. "Typical" parameters which may be provided in SCILLC data sheets and/or specifications can and do vary in different applications and actual performance may vary over time. All operating parameters, including "Typicals" must be validated for each customer application by customer's technical experts. SCILLC does not convey any license under its patent rights nor the rights of others. SCILLC products are not designed, intended, or authorized for use as components in systems intended for surgical implant into the body, or other applications intended to support or sustain life, or for any other application in which the failure of the SCILLC product could create a situation where personal injury or death may occur. Should Buyer purchase or use SCILLC products for any such unintended or unauthorized application, Buyer shall indemnify and hold SCILLC and its officers, employees, subsidiaries, affiliates, and distributors harmless against all claims, costs, damages, and expenses, and reasonable attorney fees arising out of, directly or indirectly, any claim of personal injury or death associated with such unintended or unauthorized use, even if such claim alleges that SCILLC was negligent regarding the design or manufacture of the part. SCILLC is an Equal Opportunity/Affirmative Action Employer.

### PUBLICATION ORDERING INFORMATION

#### **NORTH AMERICA Literature Fulfillment:**

Literature Distribution Center for ON Semiconductor  
P.O. Box 5163, Denver, Colorado 80217 USA  
**Phone:** 303-675-2175 or 800-344-3860 Toll Free USA/Canada  
**Fax:** 303-675-2176 or 800-344-3867 Toll Free USA/Canada  
**Email:** ONlit@hibbertco.com  
Fax Response Line: 303-675-2167 or 800-344-3810 Toll Free USA/Canada

**N. American Technical Support:** 800-282-9855 Toll Free USA/Canada

**EUROPE:** LDC for ON Semiconductor – European Support

**German Phone:** (+1) 303-308-7140 (M-F 1:00pm to 5:00pm Munich Time)  
**Email:** ONlit-german@hibbertco.com  
**French Phone:** (+1) 303-308-7141 (M-F 1:00pm to 5:00pm Toulouse Time)  
**Email:** ONlit-french@hibbertco.com  
**English Phone:** (+1) 303-308-7142 (M-F 12:00pm to 5:00pm UK Time)  
**Email:** ONlit@hibbertco.com

**EUROPEAN TOLL-FREE ACCESS\*: 00-800-4422-3781**

\*Available from Germany, France, Italy, England, Ireland

#### **CENTRAL/SOUTH AMERICA:**

**Spanish Phone:** 303-308-7143 (Mon-Fri 8:00am to 5:00pm MST)  
**Email:** ONlit-spanish@hibbertco.com

**ASIA/PACIFIC:** LDC for ON Semiconductor – Asia Support

**Phone:** 303-675-2121 (Tue-Fri 9:00am to 1:00pm, Hong Kong Time)  
Toll Free from Hong Kong & Singapore:  
**001-800-4422-3781**  
**Email:** ONlit-asia@hibbertco.com

**JAPAN:** ON Semiconductor, Japan Customer Focus Center  
4-32-1 Nishi-Gotanda, Shinagawa-ku, Tokyo, Japan 141-0031

**Phone:** 81-3-5740-2745  
**Email:** r14525@onsemi.com

**ON Semiconductor Website:** <http://onsemi.com>

For additional information, please contact your local Sales Representative.