

Total solder points: 93

Difficulty level: beginner 1 2 3 4 5 advanced

10 LED MONO VU METER

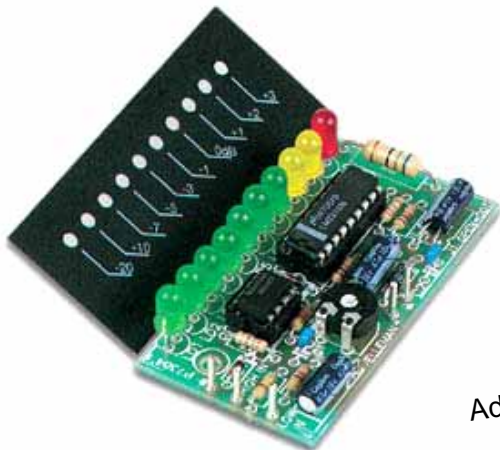

K4304

Add a visual readout to your existing or new equipment.

Features:

- ☑ For instant visualization of audio signal levels.
- ☑ Easy hook up to a LINE level (LOW input) signal source.
- ☑ For use with mixing panels, amplifiers, CD players, radio's, ...
- ☑ A special input (HIGH INPUT) is provided, which allows direct connection to a SPEAKER output .
- ☑ DOT or BAR display mode selectable to suit your application.
- ☑ Attractive display window supplied, which can be used both horizontal as vertical.
- ☑ If wanted, the unit can be calibrated by means of a trim potentiometer.

Specifications:

- 1 X 10 LED's
- Bar or dot mode.
- Indication range : 0dB = 0.775mVrms.
-20dB, -10dB, -7dB, -5dB, -3dB, -1dB, 0dB, +1dB, +2dB, +3dB
- Frequency range : 20Hz to 30KHz
- Low input for 0dB: 150mV to 6Vrms (47K)
- High input for 0dB: 1.5V to 60Vrms (470K).
- Power supply : 10 to 15VDC / 110mA max.
- PCB Dimensions : 68X37mm

 **NOT SUITED FOR CONNECTION TO HIGH POWER CAR STEREO SYSTEM**

1. Assembly (Skipping this can lead to troubles !)

Ok, so we have your attention. These hints will help you to make this project successful. Read them carefully.

1.1 Make sure you have the right tools:

- A good quality soldering iron (25-40W) with a small tip.
- Wipe it often on a wet sponge or cloth, to keep it clean; then apply solder to the tip, to give it a wet look. This is called 'thinning' and will protect the tip, and enables you to make good connections. When solder rolls off the tip, it needs cleaning.
- Thin raisin-core solder. Do not use any flux or grease.
- A diagonal cutter to trim excess wires. To avoid injury when cutting excess leads, hold the lead so they cannot fly towards the eyes.
- Needle nose pliers, for bending leads, or to hold components in place.
- Small blade and Phillips screwdrivers. A basic range is fine.

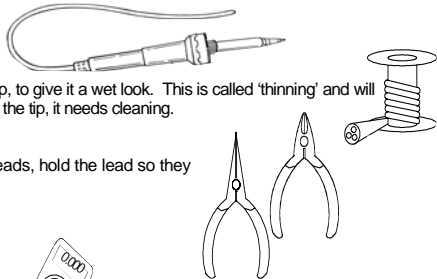

For some projects, a basic multi-meter is required, or might be handy

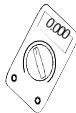

1.2 Assembly Hints :

- ⇒ Make sure the skill level matches your experience, to avoid disappointments.
 - ⇒ Follow the instructions carefully. Read and understand the entire step before you perform each operation.
 - ⇒ Perform the assembly in the correct order as stated in this manual
 - ⇒ Position all parts on the PCB (Printed Circuit Board) as shown on the drawings.
 - ⇒ Values on the circuit diagram are subject to changes.
 - ⇒ Values in this assembly guide are correct*
 - ⇒ Use the check-boxes to mark your progress.
 - ⇒ Please read the included information on safety and customer service
- * Typographical inaccuracies excluded. Always look for possible last minute manual updates, indicated as 'NOTE' on a separate leaflet.

1.3 Soldering Hints :

1- Mount the component against the PCB surface and carefully solder the leads

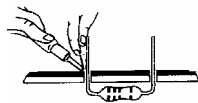

2- Make sure the solder joints are cone-shaped and shiny

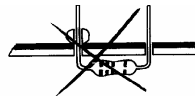
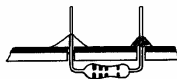

3- Trim excess leads as close as possible to the solder joint



REMOVE THEM FROM THE TAPE ONE AT A TIME !

AXIAL COMPONENTS ARE TAPED IN THE CORRECT MOUNTING SEQUENCE !

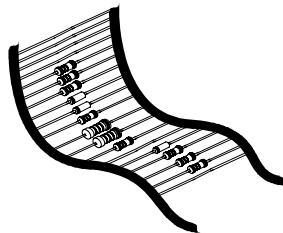

1. Jumper wires

□ J1

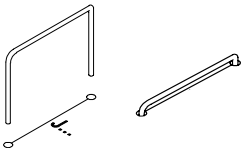

□ J2, mount for **BAR** mode, do not mount for **DOT** mode.

BAR

DOT

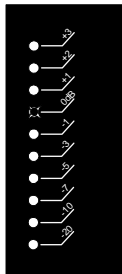
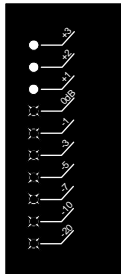

2. Diodes. Watch the polarity !

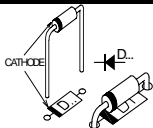

- D1 : 1N4148
- D2 : 1N4148

3. Zenerdiode. Watch the polarity !

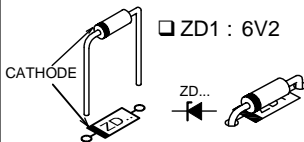

□ ZD1 : 6V2

4. Diode. Watch the polarity !

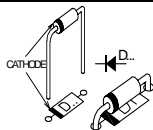

□ D3 : 1N4007

5. Resistors

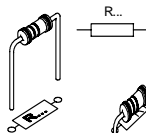

- R1 : 47K (4-7-3-B)
- R2 : 47K (4-7-3-B)
- R3 : 330 (3-3-1-B)
- R4 : 10K (1-0-3-B)
- R5 : 10K (1-0-3-B)
- R6 : 2K2 (2-2-2-B)
- R7 : 470K (4-7-4-B)

6. IC sockets. Watch the position of the notch!

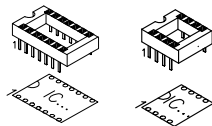

- IC1 : 8p
- IC2 : 18p

7. Capacitors.

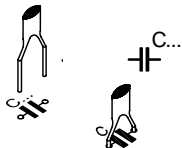

- C1 : 220nF (224)
- C2 : 220nF (224)

8. Trim potentiometer

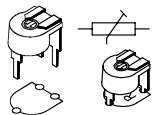

- RV1 : 220K
(Sensitivity)

9. Electrolytic Capacitors.
Watch the polarity !

- C3 : 47 μ F
- C4 : 47 μ F
- C5 : 47 μ F

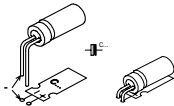

10. 1W resistor

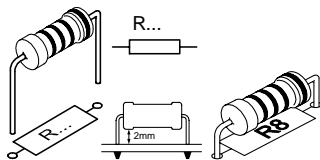

- R8 : 68 (6 - 8 - 0 - B)

11. IC's. Watch the polarity !

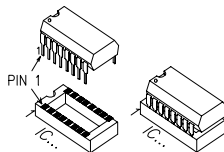

- IC1 : UA741
- IC2 : LM3916

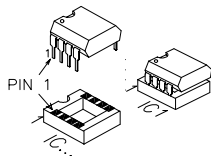

12. MOUNT THE LEDs (Check the polarity)

☞ **Remark:** Depending on your application, these LED's can be mounted perpendicular or parallel (see also points 13 and 14):

- | | | | | |
|--------------------------------------|--------------------------------------|--------------------------------------|---------------------------------------|---------------------------------------|
| <input type="checkbox"/> LD1 : green | <input type="checkbox"/> LD3 : green | <input type="checkbox"/> LD5 : green | <input type="checkbox"/> LD7 : green | <input type="checkbox"/> LD9 : yellow |
| <input type="checkbox"/> LD2 : green | <input type="checkbox"/> LD4 : green | <input type="checkbox"/> LD6 : green | <input type="checkbox"/> LD8 : yellow | <input type="checkbox"/> LD10 : red |

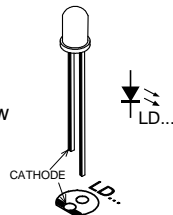

Perpendicular mounting :

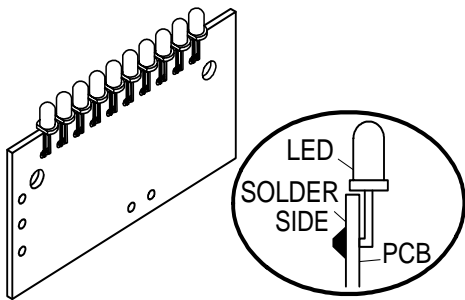

Parallel mounting :

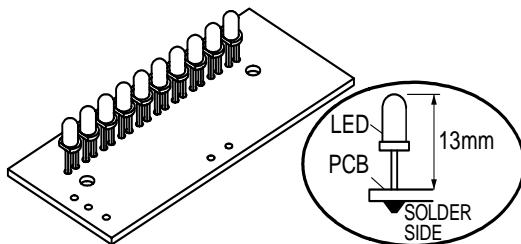

13. PARALLEL MOUNTING (optional)

(A) Make the holes in the housing or panel (fig.1.0) :

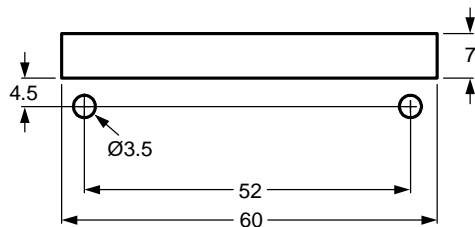

Fig. 1.0

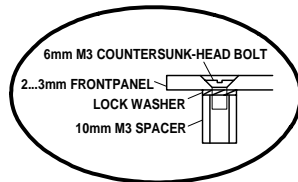
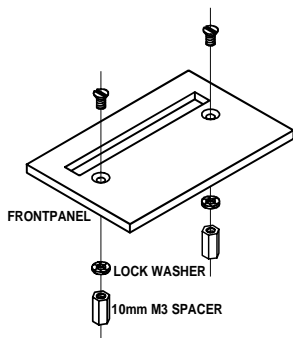
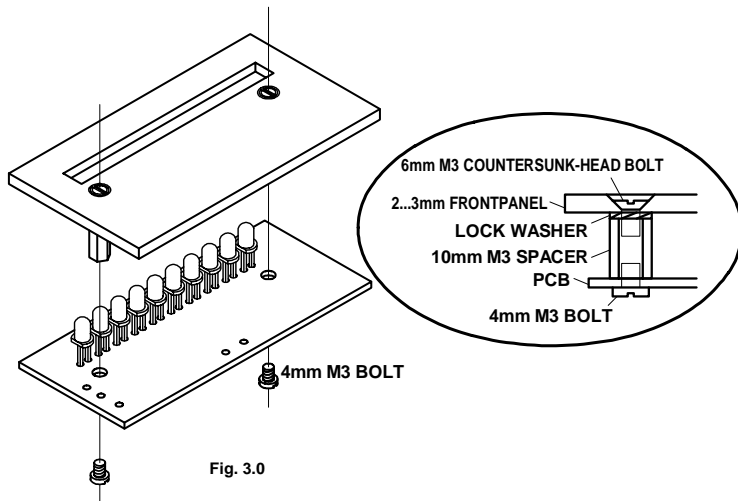

Fig. 2.0

(B) Mount the suitable spacers (fig. 2.0) :

(C) Mount the PCB onto the spacers (fig 3.0) :



14. PERPENDICULAR MOUNTING (optional)

(A) Make or search for a suitable bracket :

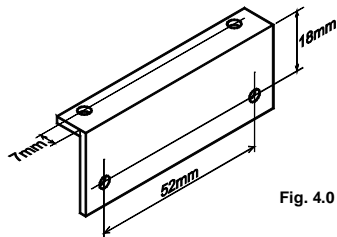

Fig. 4.0

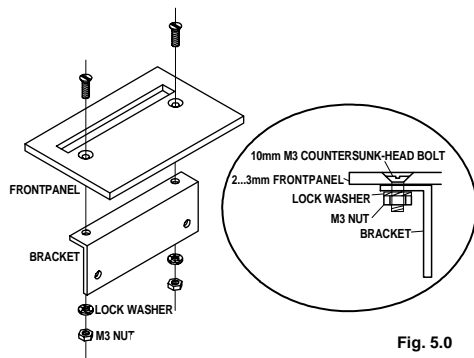

Fig. 5.0

(B) Make the holes in the housing or panel and mount the bracket (fig. 5.0) :

(C) Mount the PCB with spacers onto the bracket (fig. 6.0) :

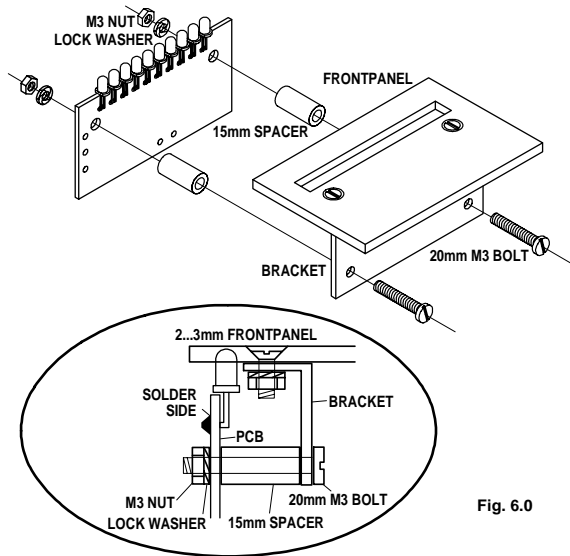

Fig. 6.0

15. CONNECTION TO A SUITABLE SIGNAL

Connecting to a line level output (tuner, preamp, cd player...) and connecting a power supply from 10 to 15VDC / 110mA max..

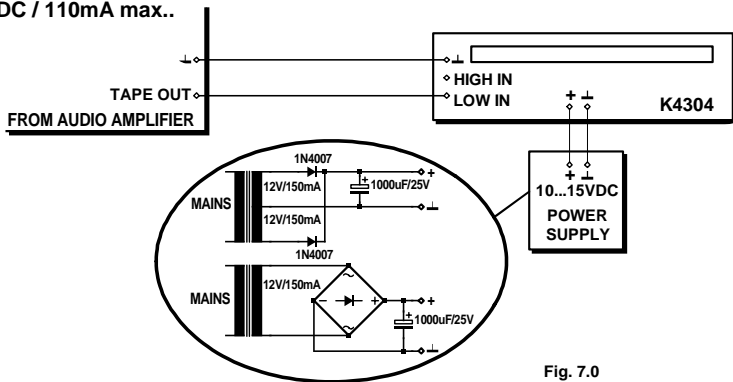

Fig. 7.0

Connect the unit to a suitable supply voltage between 10VDC and 15VDC, this can also be a standard DC adapter. You can also build your own power supply, see diagram. Use a 2x12V transformer, two rectifier diodes and a electrolytic capacitor or use a single 12V transformer with a bridge rectifier and a electrolytic capacitor.

16. CONNECTION TO A SPEAKER OUTPUT

Connecting to a speaker level output and connecting a power supply from 10 to 15VDC / 110mA max.

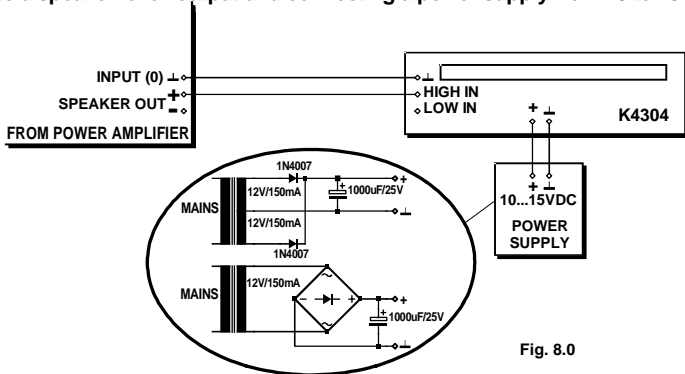
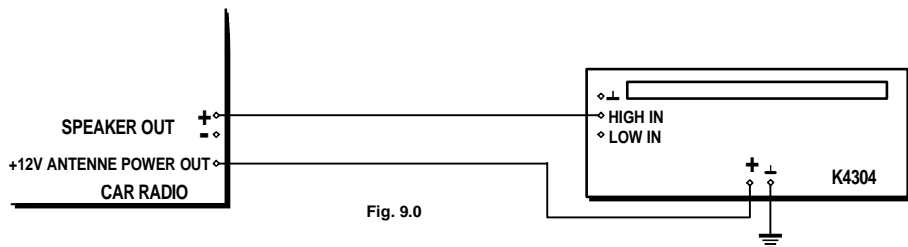

Fig. 8.0

Connect the unit to a suitable supply voltage between 10VDC and 15VDC, this can also be a standard DC adapter. You can also build your own power supply, see diagram. Use a 2x12V transformer, two rectifier diodes and a electrolytic capacitor or use a single 12V transformer with a bridge rectifier and a electrolytic capacitor.

17. CONNECTION TO A CAR RADIO

Connecting to a speaker output from a regular car radio.



The 12VDC car battery power or car radio antenna output can be used to supply the VU meter.

REMARK: Do not connect the unit to a high power car booster or car stereo, this equipment uses isolated ground connection. The connection to this kind of amplifier can cause permanent damage to the amplifier or car radio!

Adjust the units sensitivity according to your preference by means of the trim potentiometer RV1

18. PCB LAYOUT

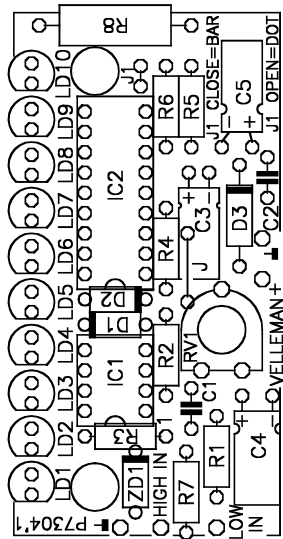

19. DIAGRAM

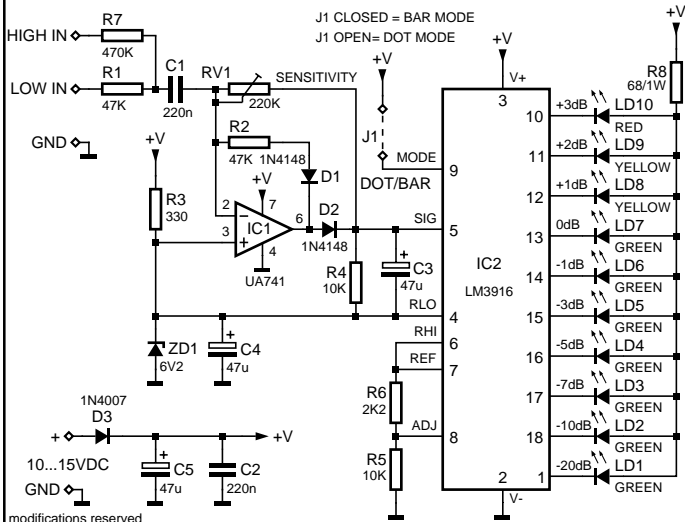



Modifications and typographical errors reserved
© Velleman Components nv.
H4304IP - 2004 - ED1

