

ARRANGEMENT OF CONTACTS								SPECIFICATIONS	
PARTS	B2001-3P	B2001-4P	B2001-5P	B2001-5A	B2001-6P	B2001-7P	B2001-8P	Contact resistance	20M Ω Max.
ANGLE	180°	216°	180°	240°	240°	270°	270°	Dielectric strength	1,000V AC/1 Minute
POSITION OF VIEWS								Insulation resistance	100M Ω Min. at 500V DC
								Rating	100V AC 2A

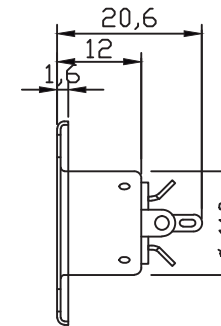
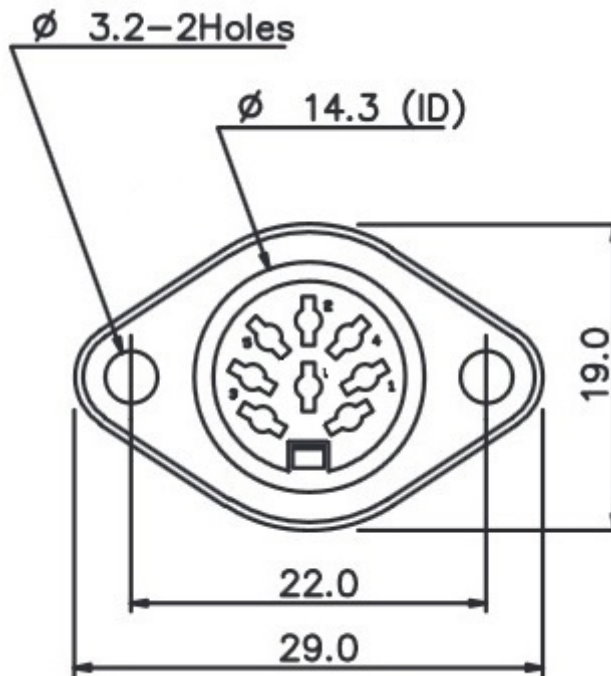

P/N	PART NAME	Q'TY	MATERIAL	PLATING	REMARKS
4	GROUNDING PIECE	1	BSR-H (0.2t) [C5191R-H]	NICKEL	3-5U*
3	CONTACT TERMINAL	5	BSR-H (0.6t) [C2680R]	NICKEL	3-5U*
2	PLASTIC CORE	1	ABS [777D]	BLACK	UL94
1	MAIN BODY	1	JIS G3141 SPCC-SD (0.5t)	NICKEL	3-5U*

GOLDSUN ELECTRONICS CO., LTD.

JAMECO NO.	15861	GOLDSUN NO.	B-2001-8P
Description	8-PIN STANDARD DIN FEMALE SOCKET METAL BODY 270		Rev. 1
UNIT:	SCALE:	SHEET 1 OF 1	CAS No: ERN No:
mm			