

Distributed by:

JAMECO[®]
ELECTRONICS

www.Jameco.com ♦ 1-800-831-4242

The content and copyrights of the attached
material are the property of its owner.

Jameco Part Number 1589849

Features

- Surface Mount Package Ideally Suited for Automated Insertion
- Very Low Leakage Current
- **Lead Free/RoHS Compliant (Note 3)**
- **"Green" Device (Notes 4 and 5)**

Mechanical Data

- Case: SOT-363
- Case Material: Molded Plastic. UL Flammability Classification Rating 94V-0
- Moisture Sensitivity: Level 1 per J-STD-020D
- Terminals: Finish - Matte Tin Solderable per MIL-STD-202, Method 208
- Lead Free Plating (Matte Tin Finish annealed over Alloy 42 leadframe).
- Polarity: See Diagram
- Marking Information: See Page 2
- Ordering Information: See Page 2
- Weight: 0.008 grams (approximate)



TOP VIEW

SOT-363

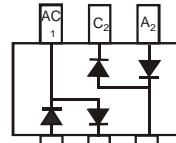

TOP VIEW
Internal Schematic

Maximum Ratings @T_A = 25°C unless otherwise specified

| Characteristic | Symbol | Value | Unit | |
|---|------------------------------|------------------|------------|----|
| Peak Repetitive Reverse Voltage | V _{RRM} | 85 | V | |
| Working Peak Reverse Voltage | V _{RWM} | | | |
| DC Blocking Voltage | V _R | | | |
| RMS Reverse Voltage | V _{R(RMS)} | 60 | V | |
| Forward Continuous Current (Note 2) | Single diode Double diode | I _{FM} | 160 140 | mA |
| | | I _{FRM} | 500 | mA |
| Repetitive Peak Forward Current (Note 2) | | | | |
| Non-Repetitive Peak Forward Surge Current | | @ t = 1.0µs | 4.0 | A |
| | | @ t = 1.0ms | 1.0 | |
| | | @ t = 1.0s | 0.5 | |

Thermal Characteristics

| Characteristic | Symbol | Value | Unit |
|---|-----------------------------------|-------------|------|
| Power Dissipation (Note 2) | P _D | 200 | mW |
| Thermal Resistance Junction to Ambient Air (Note 2) | R _{θJA} | 625 | °C/W |
| Operating and Storage Temperature Range | T _J , T _{STG} | -65 to +150 | °C |

Electrical Characteristics @T_A = 25°C unless otherwise specified

| Characteristic | Symbol | Min | Typ | Max | Unit | Test Condition |
|------------------------------------|--------------------|-----|-----|-----------|----------|---|
| Reverse Breakdown Voltage (Note 1) | V _{(BR)R} | 85 | — | — | V | I _R = 100µA |
| Forward Voltage | V _F | — | — | 0.90 | V | I _F = 1.0mA |
| | | | | 1.0 | | I _F = 10mA |
| | | | | 1.1 | | I _F = 50mA |
| | | | | 1.25 | | I _F = 150mA |
| Leakage Current (Note 1) | I _R | — | — | 5.0 80 | nA nA | V _R = 75V V _R = 75V, T _J = 150°C |
| Total Capacitance | C _T | — | 2 | — | pF | V _R = 0, f = 1.0MHz |
| Reverse Recovery Time | t _{rr} | — | — | 3.0 | µs | I _F = I _R = 10mA, I _{rr} = 0.1 x I _R , R _L = 100Ω |

- Notes:
1. Short duration pulse test used to minimize self-heating effect.
 2. Part mounted on FR-4 PC board with recommended pad layout, which can be found on our website at <http://www.diodes.com/datasheets/ap02001.pdf>.
 3. No purposefully added lead.
 4. Diodes Inc.'s "Green" policy can be found on our website at http://www.diodes.com/products/lead_free/index.php.
 5. Product manufactured with Date Code UO (week 40, 2007) and newer are built with Green Molding Compound. Product manufactured prior to Date Code UO are built with Non-Green Molding Compound and may contain Halogens or Sb₂O₃ Fire Retardants.

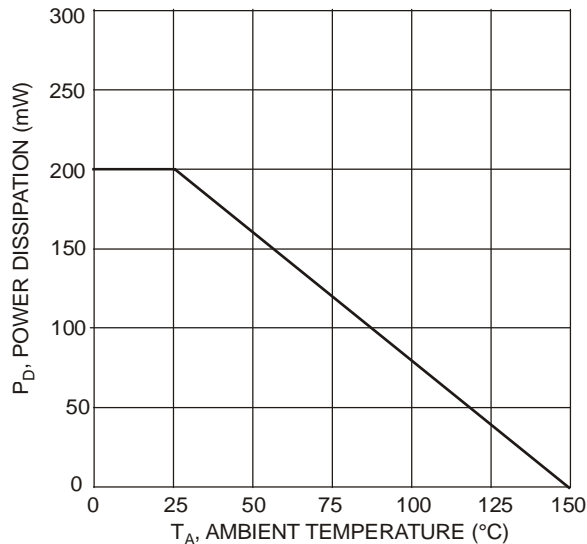

Fig. 1 Power Derating Curve, Total Package

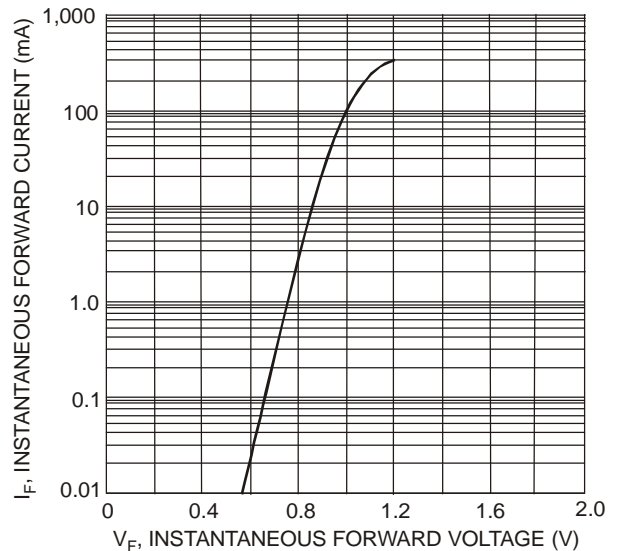

Fig. 2 Typical Forward Characteristics, Per Element

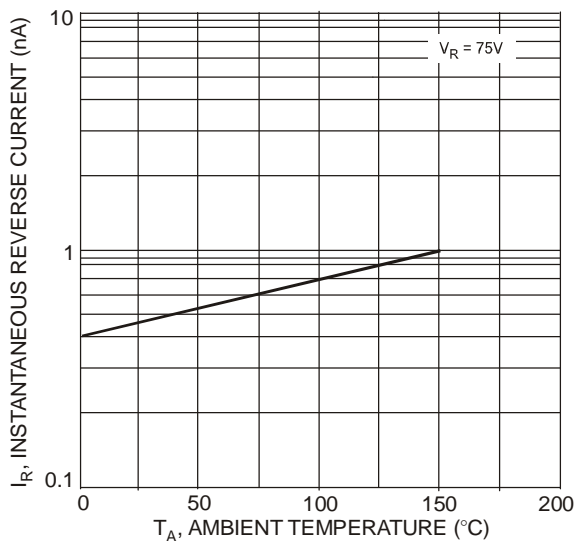

Fig. 3 Typical Reverse Characteristics, Per Element

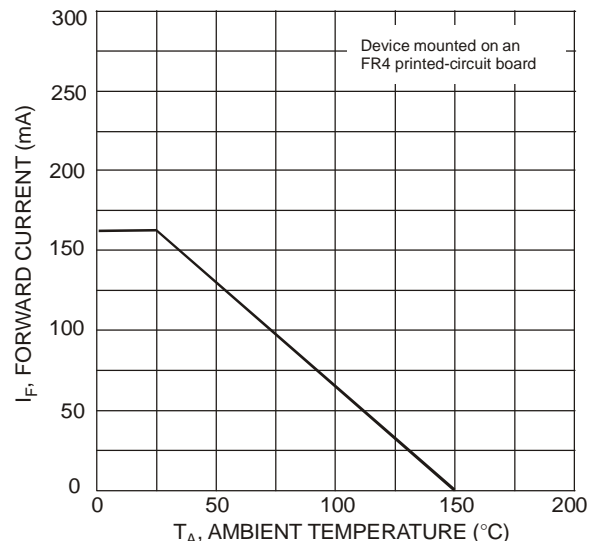

Fig. 4 Current Derating Curve, Per Element

Ordering Information (Notes 5 & 6)

| Part Number | Case | Packaging |
|--------------|---------|------------------|
| BAV199DW-7-F | SOT-363 | 3000/Tape & Reel |

Notes: 6. For packaging details, go to our website at <http://www.diodes.com/datasheets/ap02007.pdf>.

Marking Information

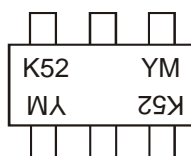

K52 = Product Type Marking Code
 YM = Date Code Marking
 Y = Year ex: T = 2006
 M = Month ex: 9 = September

Date Code Key

| Year | 2006 | 2007 | 2008 | 2009 | 2010 | 2011 | 2012 |
|------|------|------|------|------|------|------|------|
| Code | T | U | V | W | X | Y | Z |

| Month | Jan | Feb | Mar | Apr | May | Jun | Jul | Aug | Sep | Oct | Nov | Dec |
|-------|-----|-----|-----|-----|-----|-----|-----|-----|-----|-----|-----|-----|
| Code | 1 | 2 | 3 | 4 | 5 | 6 | 7 | 8 | 9 | O | N | D |

Package Outline Dimensions

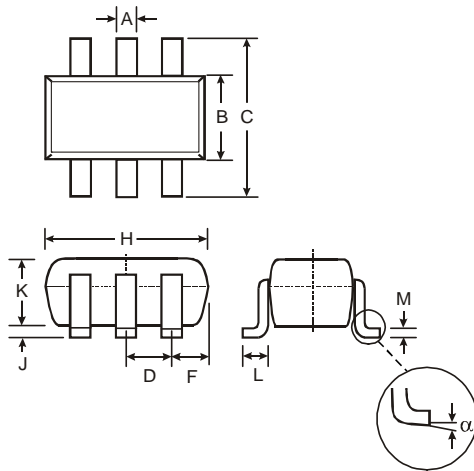

| SOT-363 | | |
|----------------------|--------------|------|
| Dim | Min | Max |
| A | 0.10 | 0.30 |
| B | 1.15 | 1.35 |
| C | 2.00 | 2.20 |
| D | 0.65 Nominal | |
| F | 0.30 | 0.40 |
| H | 1.80 | 2.20 |
| J | — | 0.10 |
| K | 0.90 | 1.00 |
| L | 0.25 | 0.40 |
| M | 0.10 | 0.25 |
| α | 0° | 8° |
| All Dimensions in mm | | |

Suggested Pad Layout

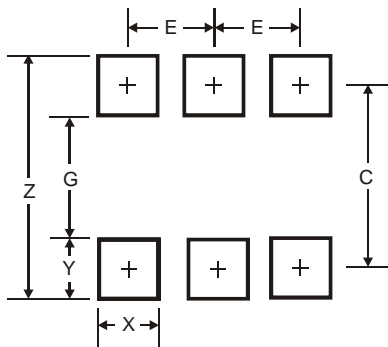

| Dimensions | Value (in mm) |
|------------|---------------|
| Z | 2.5 |
| G | 1.3 |
| X | 0.42 |
| Y | 0.6 |
| C | 1.9 |
| E | 0.65 |

IMPORTANT NOTICE

Diodes Incorporated and its subsidiaries reserve the right to make modifications, enhancements, improvements, corrections or other changes without further notice to any product herein. Diodes Incorporated does not assume any liability arising out of the application or use of any product described herein; neither does it convey any license under its patent rights, nor the rights of others. The user of products in such applications shall assume all risks of such use and will agree to hold Diodes Incorporated and all the companies whose products are represented on our website, harmless against all damages.

LIFE SUPPORT

Diodes Incorporated products are not authorized for use as critical components in life support devices or systems without the expressed written approval of the President of Diodes Incorporated.