

Distributed by:

JAMECO[®]
ELECTRONICS

www.Jameco.com ♦ 1-800-831-4242

The content and copyrights of the attached
material are the property of its owner.

Jameco Part Number 162886

A Wide Range of Models:

6 × 6 mm, 12 × 12 mm, Side-operated, High-force, and Gold-plated.

- A positive click action plus a long life equal to that of a no-contact switch.
- Radial models (taping specifications) that allow the use of general-purpose radial taping parts insertion machines have been added to the series.
- Series also includes gold-plated models delivering long-term contact and insulation reliability.
- Projected plunger types that allow the installation of B32-series Special Key Tops are available.

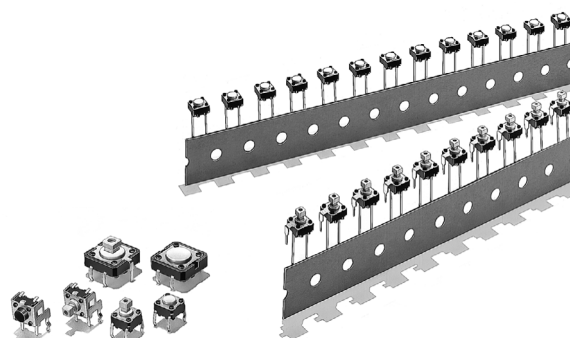



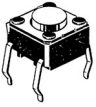
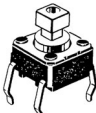

RoHS Compliant (Refer to page 8 for details.)

Ordering Information

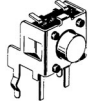
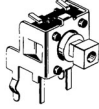
6 × 6 mm Models

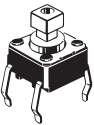
Type	Plunger	Height	Operating force (OF)	Bags (in units of 100 Switches)		
				Without ground terminal	With ground terminal	
Standard (B3F-1000)	Flat type 	4.3 mm	0.98 N {100 gf}	B3F-1000	B3F-1100	
			1.47 N {150 gf}	B3F-1002	B3F-1102	
			2.55 N {260 gf}	B3F-1005	B3F-1105	
			4.9 N {50 gf}	B3F-1006	---	
		5.0 mm	0.98 N {100 gf}	B3F-1020	B3F-1120	
			1.47 N {150 gf}	B3F-1022	B3F-1122	
			2.55 N {260 gf}	B3F-1025	B3F-1125	
			4.9 N {50 gf}	B3F-1026	---	
		5.0 mm (7.5-mm pitch)	0.98 N {100 gf}	---	B3F-1110	
		9.5 mm	7.0 mm	0.98 N {100 gf}	B3F-1060	---
				1.47 N {150 gf}	B3F-1062	---
			9.5 mm	0.98 N {100 gf}	B3F-1070	---
	1.47 N {150 gf}			B3F-1072	---	
	2.55 N {260 gf}	B3F-1075	---			
	Projected type 	7.3 mm	0.98 N {100 gf}	B3F-1050	B3F-1150	
			1.47 N {150 gf}	B3F-1052	B3F-1152	
2.55 N {260 gf}			B3F-1055	B3F-1155		
4.9 N {50 gf}			B3F-1056	---		

Type	Plunger	Height	Operating force (OF)	Bags (in units of 100 Switches)	
				Without ground terminal	With ground terminal
Side-operated (B3F-3000)	 Flat type	3.15 mm	0.98 N {100 gf}	---	B3F-3100
			1.47 N {150 gf}	---	B3F-3102
			2.55 N {260 gf}	---	B3F-3105
		3.85 mm	0.98 N {100 gf}	---	B3F-3120
			1.47 N {150 gf}	---	B3F-3122
			2.55 N {260 gf}	---	B3F-3125
	 Projected type	6.15 mm	0.98 N {100 gf}	---	B3F-3150
			1.47 N {150 gf}	---	B3F-3152
			2.55 N {260 gf}	---	B3F-3155
Gold-plated (B3F-G)	 Flat type	4.3 mm	1.76 N {179 gf}	B3F-1002-G	B3F-1102-G
		5.0 mm		B3F-1022-G	B3F-1122-G
		7.0 mm		B3F-1062-G	---
		9.5 mm		B3F-1072-G	---
	 Projected type	7.3 mm		B3F-1052-G	---
	 Flat type	3.85 mm		---	B3F-3122-G

Note: Orders must be made in multiples of 100 (the quantity per bag).

12 × 12 mm Models

Type	Plunger (or LED color)	Height	Operating force (OF)	Bags (in units of 100 Switches)	
				Without ground terminal	With ground terminal
Standard (B3F-4000)	Flat type	4.3 mm	1.27 N {130 gf}	B3F-4000	B3F-4100
			2.55 N {260 gf}	B3F-4005	B3F-4105
	Projected type	7.3 mm	1.27 N {130 gf}	B3F-4050	B3F-4150
			2.55 N {260 gf}	B3F-4055	B3F-4155
Long life expectancy (B3F-5000)	Flat type	4.3 mm	1.27 N {130 gf}	B3F-5000	B3F-5100
	Projected type	7.3 mm		B3F-5050	B3F-5150
High reliability gold-plated (B3F-5001)	Flat type	4.3 mm	1.27 N {130 gf}	B3F-5001	B3F-5101
	Projected type	7.3 mm		B3F-5051	B3F-5151

Note: Orders must be made in multiples of 100 (the quantity per bag).

6 × 6 mm Radial Models (Taping Specifications)

Type	Plunger	Height	Operating force: 0.98 N {100 gf}		Operating force: 1.47 N {150 gf}	
			Without ground terminal	With ground terminal	Without ground terminal	With ground terminal
Radial models (B3F-6000)	Flat type	4.3 mm	B3F-6000	B3F-6100	B3F-6002	B3F-6102
		5.0 mm	B3F-6020	B3F-6120	B3F-6022	B3F-6122
	Projected type	7.3 mm	B3F-6050	B3F-6150	B3F-6052	B3F-6152

Note: Orders must be made in multiples of 1,000. Switches are not sold individually.

Specifications

■ Ratings/Characteristics

Switching capacity	1 to 50 mA, 5 to 24 VDC (resistive load) B3F-G: 100 μ A to 50 mA, 5 to 24 VDC
Ambient operating temperature	-25°C to 70°C at 60% max. humidity (with no icing or condensation)
Ambient operating humidity	35% to 85% (at 5 to 35°C)
Contact form	SPST-NO
Contact resistance	100 m Ω max. (initial value) (rated: 1 mA, 5 VDC) B3F-G: (rated: 100 μ A, 5 VDC)
Insulation resistance	100 M Ω min. (at 250 VDC)
Dielectric strength	500 VAC, 50/60 Hz for 1 min
Bounce time	5 ms max.
Vibration resistance	Malfunction: 10 to 55 Hz, 1.5 mm double amplitude
Shock resistance	Destruction: 1,000 m/s ² {approx. 100G} max. Malfunction: 100 m/s ² {approx. 10G} max.
Life expectancy	B3F-1000, B3F-3000, B3F-6000: 1,000,000 operations min (OF: 0.98 N {100 gf}) (B3F-1070: 500,000 operations min) 300,000 operations min (OF: 1.47 N {150 gf}) 100,000 operations min (OF: 2.55 N {260 gf}) 50,000 operations min (OF: 4.9 N {500 gf}) B3F-4000: 3,000,000 operations min (OF: 1.27 N {131 gf}) 1,000,000 operations min (OF: 2.55 N {260 gf}) B3F-5000: 10,000,000 operations min. B3F-G: 300,000 operations min.
Weight	6 \times 6 mm models: approx. 0.25 g 12 \times 12 mm models (standard types): approx. 0.85 g Radial models: approx. 0.25 g

■ Operating Characteristics

Operating force (OF)	B3F-1000, B3F-3000, B3F-6000				B3F-4000, B3F-5000		B3F-G
	0.98 N	1.47 N	2.55 N	4.9 N	1.27 N	2.55 N	1.76 N
Item	B3F-1□□□0 B3F-3□□□0 B3F-6□□□0	B3F-1□□□2 B3F-3□□□2 B3F-6□□□2	B3F-1□□□5 B3F-3□□□5	B3F-10□□6	B3F-4□□□0 B3F-5□□□0	B3F-4□□□5	B3F-1□□□2-G B3F-3□□□2-G
Operating force (OF)	0.98 \pm 0.29 N {100 \pm 30 gf}	1.47 \pm 0.49 N {150 \pm 50 gf}	2.55 \pm 0.69 N {260 \pm 70 gf}	4.9 \pm 1.47 N {500 \pm 150 gf}	1.27 \pm 0.49 N {130 \pm 50 gf}	2.55 \pm 0.69 N {260 \pm 70 gf}	1.76 \pm 0.49 N {180 \pm 50 gf}
Releasing force (RF)	0.2 N {20 gf} min.	0.49 N {50 gf} min.	0.49 N {50 gf} min.	0.7 N {70 gf} min.	0.29 N {30 gf} min.	0.49 N {50 gf} min.	0.49 N {50 gf} min.
Pretravel (PT)	0.25 ^{+0.2} / _{-0.1} mm				0.3 ^{+0.2} / _{-0.1} mm		0.25 ^{+0.2} / _{-0.1} mm

Dimensions

- Note:** 1. All units are in millimeters unless otherwise indicated. Unless otherwise specified, a tolerance of ± 0.4 mm applies to all dimensions.
2. No terminal numbers are indicated on the Switches. The numbers used for terminals in the following graphics are indicated in the "Bottom View" diagram below. In this diagram, the Switch is rotated so that the terminals are on the right and left-hand sides, and the OMRON logo appears the right way up. (Except Side-operated and Radial Models)



6 × 6 mm Models

Standard, Flat Plunger Type (without Ground Terminal)

B3F-1000, B3F-1002, B3F-1005, B3F-1006
 B3F-1020 (See note.), B3F-1022 (See note.),
 B3F-1025 (See note.), B3F-1026 (See note.)
 B3F-1002-G
 B3F-1022-G (See note.)

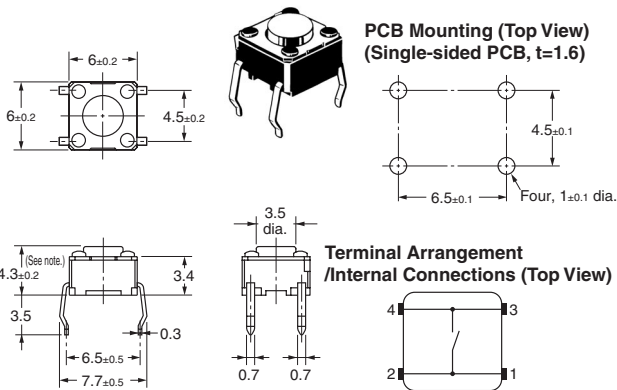

Note: The height of B3F-1020, B3F-1022, B3F-1025, and B3F-1026 is 5 ± 0.2 mm.

Standard, Flat Plunger Type (with Ground Terminal, Pitch: 6.5 mm)

B3F-1100, B3F-1102, B3F-1105
 B3F-1120 (See note.), B3F-1122 (See note.)
 B3F-1125 (See note.)
 B3F-1102-G
 B3F-1122-G (See note.)

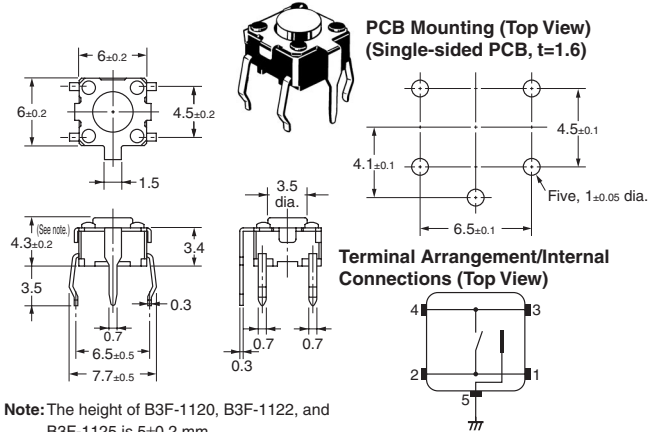

Note: The height of B3F-1120, B3F-1122, and B3F-1125 is 5 ± 0.2 mm.

Standard, Flat Plunger Type (with Ground Terminal, Pitch: 7.5 mm)

B3F-1110

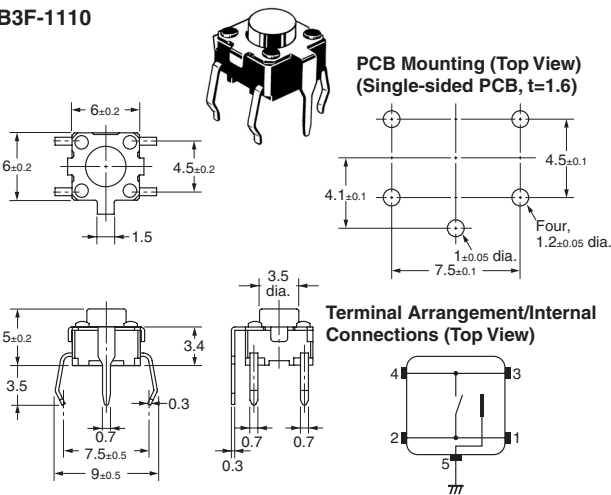

Standard, Flat Plunger Type (without Ground Terminal)

B3F-1060, B3F-1062, B3F-1062-G

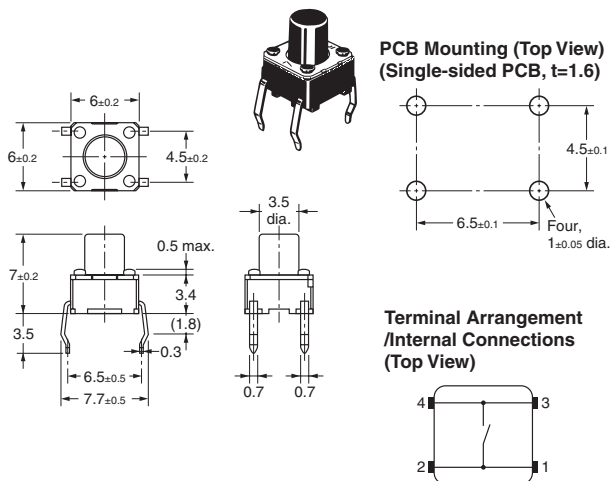

**Standard, Flat Plunger Type
(without Ground Terminal)**

B3F-1070, B3F-1072-N, B3F-1075, B3F-1072-G

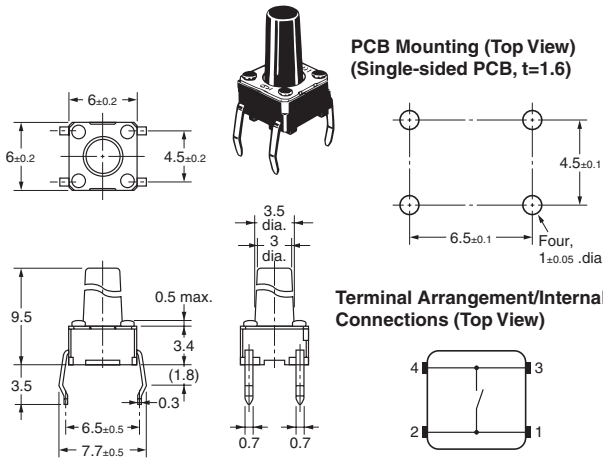

**Standard, Projected Plunger Type
(without Ground Terminal)**

**B3F-1050, B3F-1052
B3F-1055, B3F-1056
B3F-1052-G**

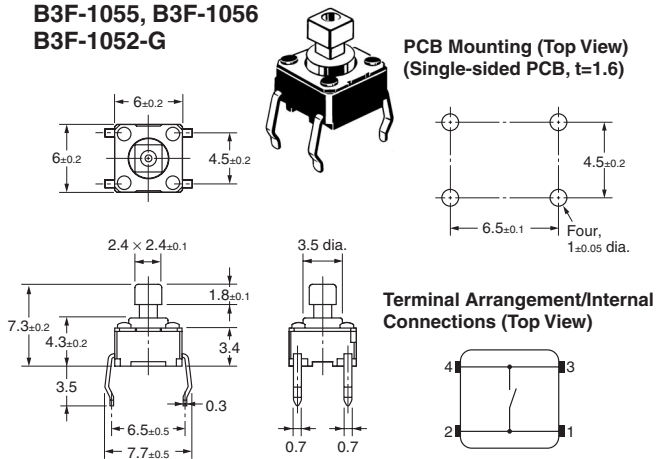

**Standard, Projected Plunger Type
(with Ground Terminal)**

B3F-1150, B3F-1152, B3F-1155

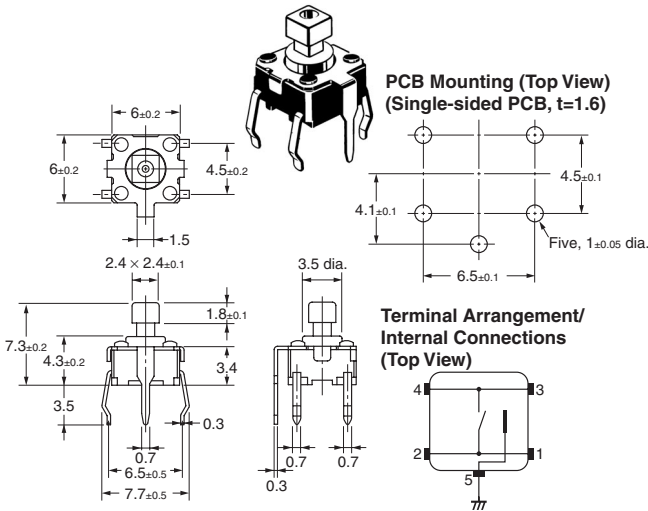

Side-operated, Flat Plunger Type

B3F-3100, B3F-3102, B3F-3105

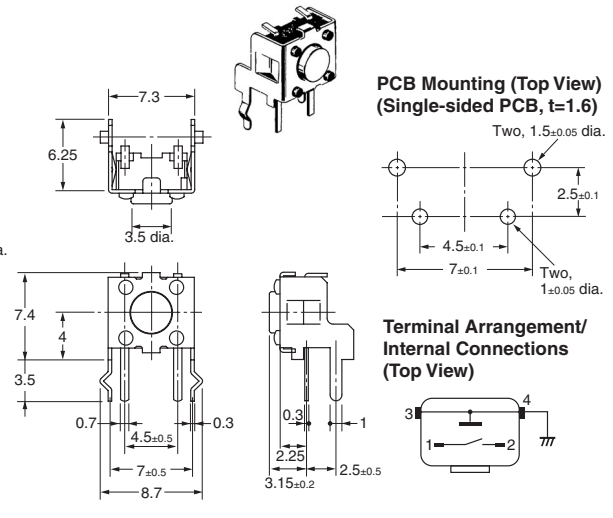

Side-operated, Flat Plunger Type (Height: 3.85 mm)

B3F-3120, B3F-3122, B3F-3125, B3F-3122-G

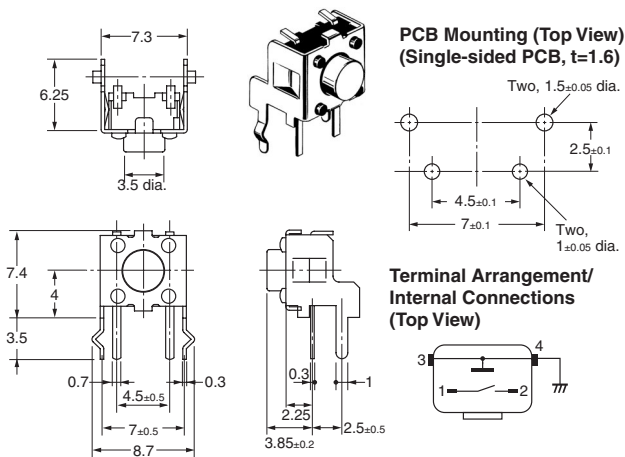

Side-operated, Projected Plunger Type

B3F-3150, B3F-3152, B3F-3155

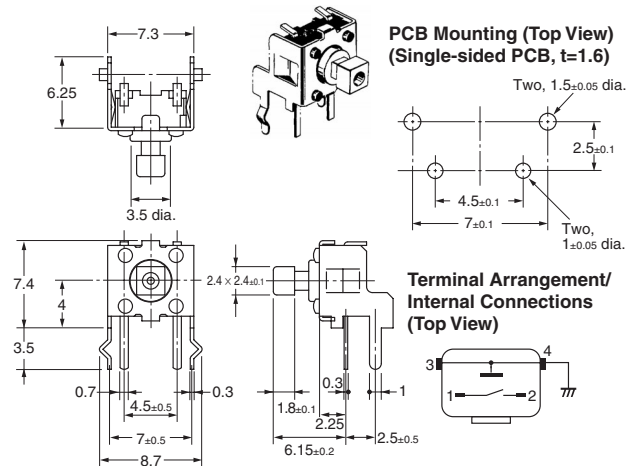

12 × 12 mm Models

Standard, Long-life,
and High-reliability Models
Flat Plunger Type
(without Ground Terminal)

B3F-4000, B3F-4005,
B3F-5000, B3F-5001

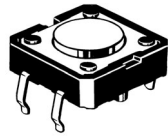

PCB Mounting (Top View)
(Single-sided PCB, t=1.6)

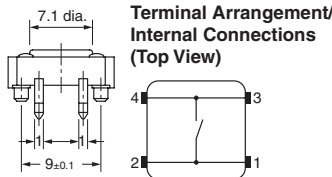
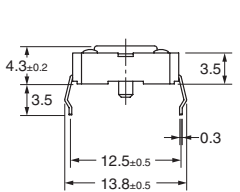
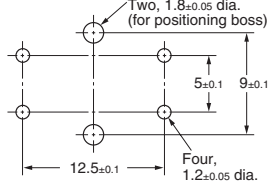
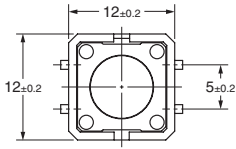

Standard, Long-life,
and High-reliability Models
Flat Plunger Type
(with Ground Terminal)

B3F-4100, B3F-4105,
B3F-5100, B3F-5101

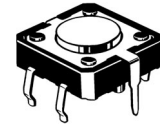

PCB Mounting (Top View)
(Single-sided PCB, t=1.6)

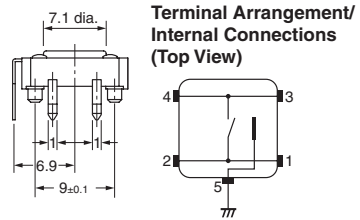
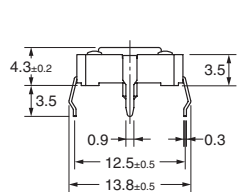
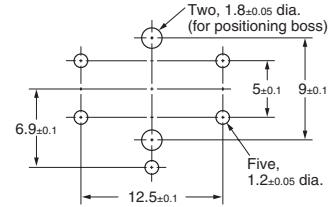
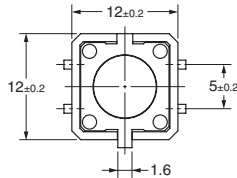

Standard, Long-life,
and High-reliability Models
Projected Plunger Type
(without Ground Terminal)

B3F-4050, B3F-4055,
B3F-5050, B3F-5051

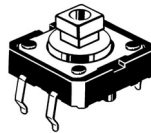

PCB Mounting (Top View)
(Single-sided PCB, t=1.6)

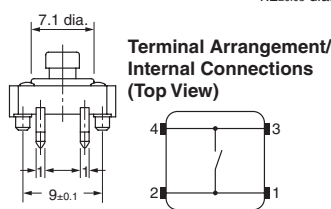
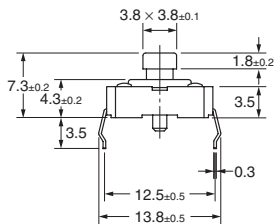
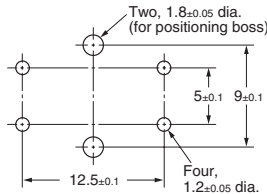
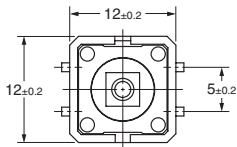

Standard, Long-life,
and High-reliability Models
Projected Plunger Type
(with Ground Terminal)

B3F-4150, B3F-4155,
B3F-5150, B3F-5151

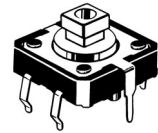

PCB Mounting (Top View)
(Single-sided PCB, t=1.6)

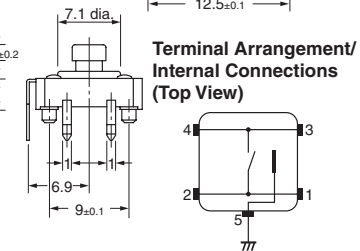
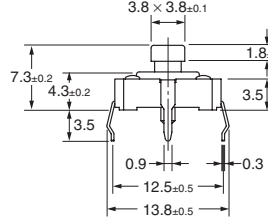
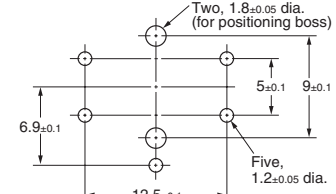
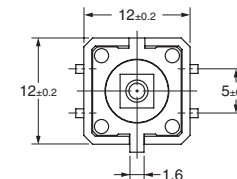

Note: The numbers used for terminals in the following graphics are indicated in the "Bottom View" diagram below. In this diagram, the Switch is rotated so that the terminals are on the right and left-hand sides, and the OMRON logo appears the right way up.

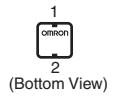

6 mm × 6 mm Radial Types (Taping Specifications): Sold in Units of 1,000 Switches

**Flat Plunger Type
(without Ground Terminal)
B3F-6000, B3F-6002**

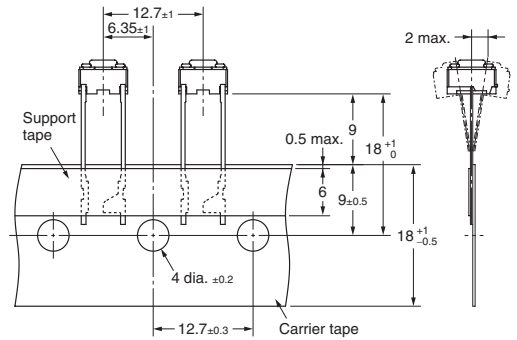
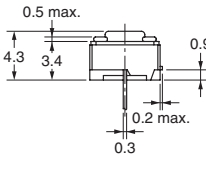
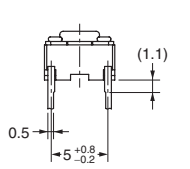
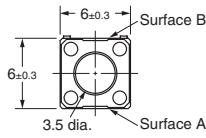
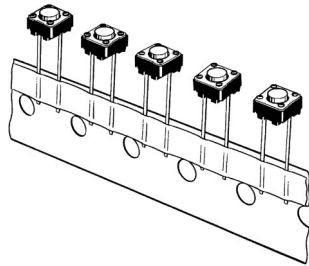

**PCB Mounting
(Top View)
(Single-sided PCB, t=1.6)**

**Terminal Arrangement
/Internal Connections
(Top View)**

Note: The tape is random between surface A and surface B.

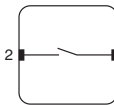
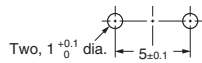

**Flat Plunger Type
(with Ground Terminal)
B3F-6100, B3F-6102**

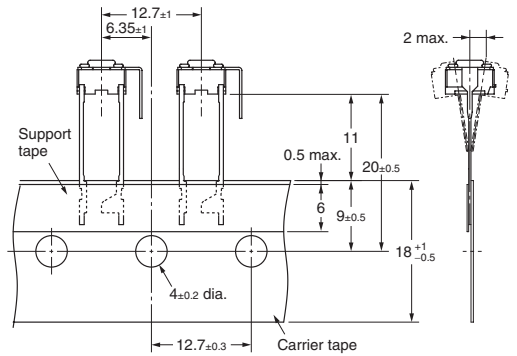
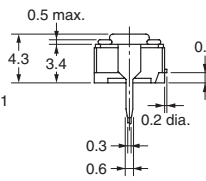
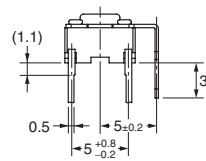
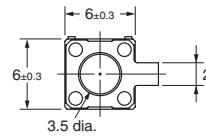
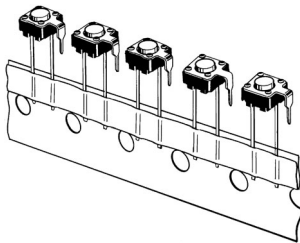

**PCB Mounting
(Top View)
(Single-sided PCB, t=1.6)**

**Terminal Arrangement
/Internal Connections
(Top View)**

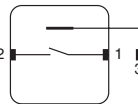
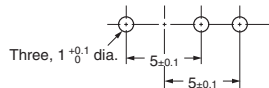

**Flat Plunger Type
(without Ground Terminal)
B3F-6020, B3F-6022**

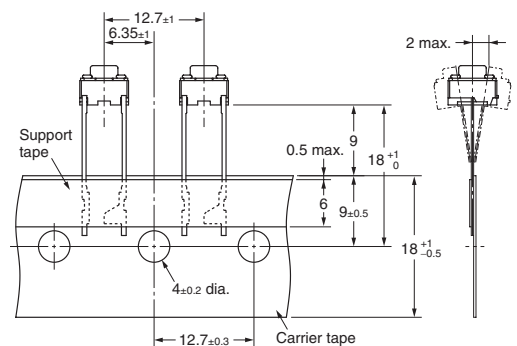
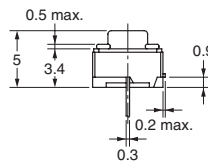
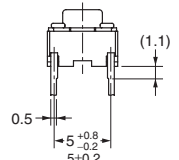
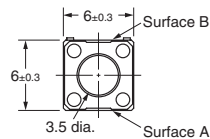
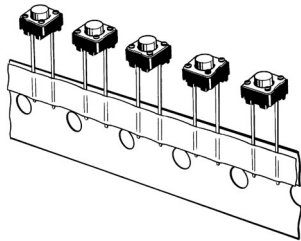

**PCB Mounting
(Top View)
(Single-sided PCB, t=1.6)**

**Terminal Arrangement
/Internal Connections
(Top View)**

Note: The tape is random between surface A and surface B.

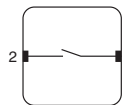
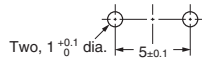

**Flat Plunger Type
(with Ground Terminal)
B3F-6120, B3F-6122**

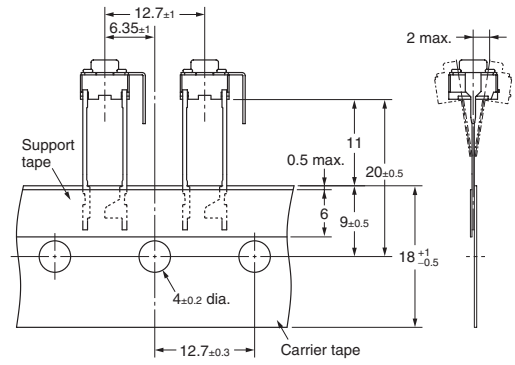
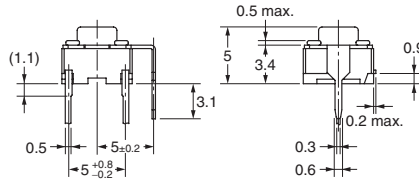
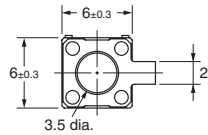
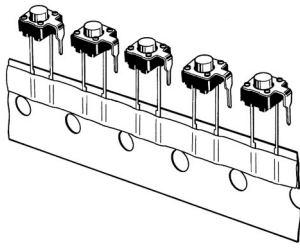

**PCB Mounting
(Top View)
(Single-sided PCB, t=1.6)**

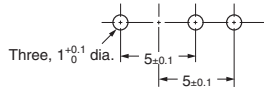

**Terminal Arrangement
/Internal Connections
(Top View)**

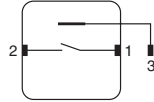

**Projected Plunger Type
(without Ground Terminal)
B3F-6050, B3F-6052**

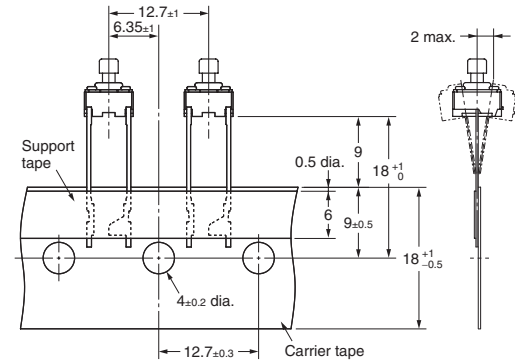
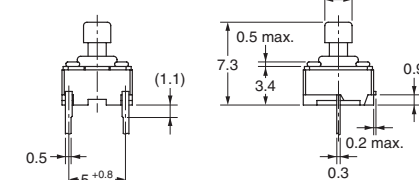
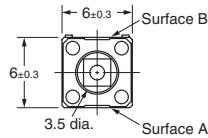
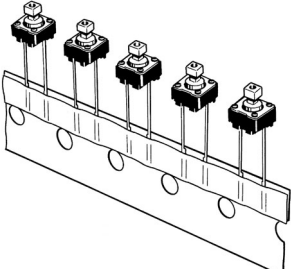

**PCB Mounting
(Top View)
(Single-sided PCB, t=1.6)**

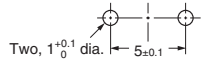

**Terminal Arrangement
/Internal Connections
(Top View)**

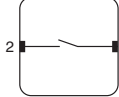

Note: The tape is random between surface A and surface B.

**Projected Plunger Type
(with Ground Terminal)
B3F-6150, B3F-6152**

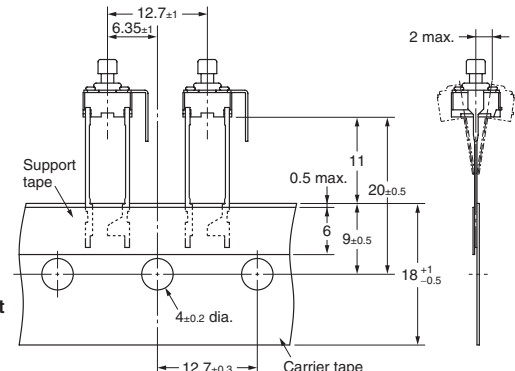
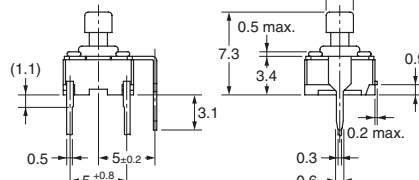
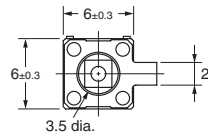
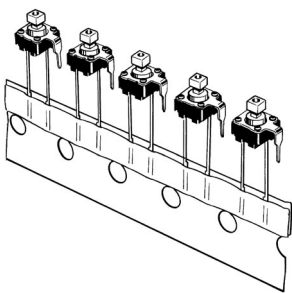

**PCB Mounting
(Top View)
(Single-sided PCB, t=1.6)**

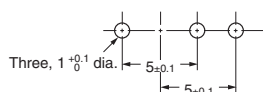

**Terminal Arrangement
/Internal Connections
(Top View)**

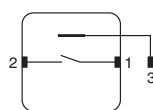

Key Tops

B32-series Special Key Tops are available for projected plunger models. Refer to page 42 for details.

Precautions

Be sure to read the precautions common to all Tactile Switches on pages 5 to 7 for correct use.

ALL DIMENSIONS SHOWN ARE IN MILLIMETERS.

To convert millimeters into inches, multiply by 0.03937. To convert grams into ounces, multiply by 0.03527.