

Distributed by:

**JAMECO**<sup>®</sup>  
ELECTRONICS

**www.Jameco.com ♦ 1-800-831-4242**

The content and copyrights of the attached  
material are the property of its owner.

Jameco Part Number 16935

# FP-108-1

119x119x38mm VENUS



DIMENSION:MM

## DESIGN FEATURES

\***BEARING SYSTEM:** SLEEVE BEARING & BALL BEARING\***WEIGHT:** 550 (g)\***IMPELLER:** PLASTIC WITH FIBER GLASS FILLED UL 94V-0\***HOUSING:** DIE CAST ALUMINUM PAINTED BLACK OR NATURAL COLOR PBT PLASTIC UL 94V-0\***MOTOR:** SHADED POLE, IMPEDANCE PROTECTED\***CONNECTING:** TERMINAL & WIRE LEADS

\***SPEED:** S-1 HIGH SPEED TYPE  
 S-2 MEDIUM SPEED TYPE  
 S-3 LOW SPEED TYPE

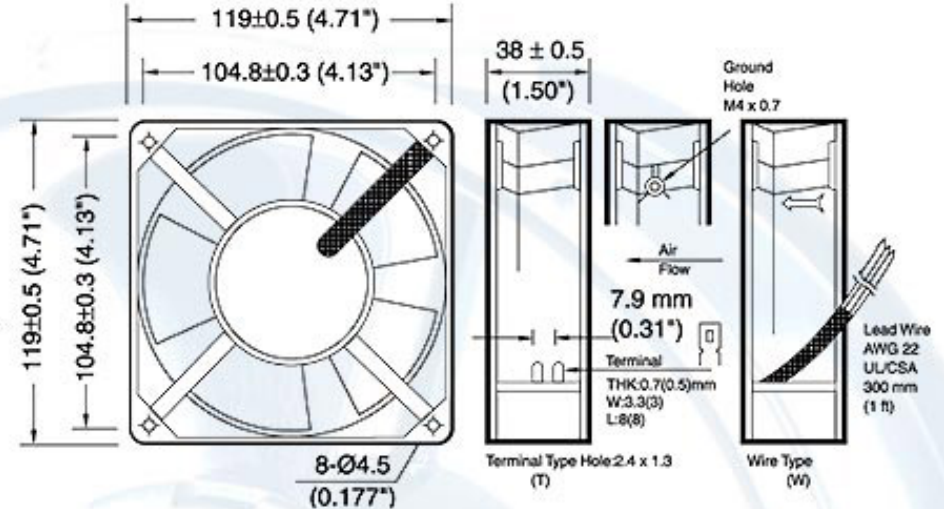
\***OTHER VOLTAGE:** 24 ,48 ,100 ,380AC (50/60Hz) ARE AVAILABLE

## SPECIFICATIONS

Model No.	Voltage (VDC)	Frequency (HZ)	Air (CFM)	Volume (M <sup>3</sup> /Min)	Current (A)	Power (W)	Speed (RPM)	Static pressure (Inch-H <sub>2</sub> O)	Noise (dBA)
**NEW FP-108-1 (S-ULTRA)	110/120	50/60	112/120	3.18/3.40	0.25/0.19	18/19	2700/3000	0.27/0.30	40/45
	220/240	50/60	112/120	3.18/3.40	0.25/0.19	18/19	2700/3000	0.27/0.30	40/45
FP-108-1 (S-1)	110/120	50/60	80/105	2.3/3.0	0.24/0.18	18/17	2700/3000	0.23/0.28	42/47
	220/240	50/60	80/105	2.3/3.0	0.13/0.11	18/17	2700/3000	0.23/0.28	42/47
FP-108-1 (S-2)	110/120	50/60	63/71	1.65/1.85	0.13/0.12	11/10	2200/2500	0.19/0.21	37/39
	220/240	50/60	63/71	1.65/1.85	0.11/0.09	11/10	2200/2500	0.19/0.21	37/39
FP-108-1 (S-3)	110/120	50/60	54/52	1.5/1.4	0.11/0.10	9/8	1800/2000	0.16/0.15	30/34
	220/240	50/60	54/52	1.5/1.4	0.08/0.06	9/8	1800/2000	0.16/0.15	30/34

## PERFORMANCE

