

Distributed by:

JAMECO[®]
ELECTRONICS

www.Jameco.com ♦ 1-800-831-4242

The content and copyrights of the attached
material are the property of its owner.

Jameco Part Number 1710813

MINI® Blade Fuse Rated 32V

RoHS

Blade Fuses



Specifications

Interrupting Rating: 1000A @ 32 VDC
Voltage Rating: 32 VDC
Operating Temperature Range: -40°C to +125°C

The MINI Fuse is quickly becoming the new standard for vehicle circuit protection. Its miniature design meets the need for more circuits to be protected while utilizing less space, and its ability to cope with high temperatures in adverse environments makes the MINI Fuse the recommended choice for protection.

Die MINI®-Sicherung entwickelt sich rasch zum neuen Standard für den Schaltungsschutz in Fahrzeugen. Ihr Miniatur-Design ermöglicht es, mehr Schaltkreise bei insgesamt geringerem Platzbedarf zu schützen. Kleinste Abmessungen in Kombination mit der für raue Umgebungsbedingungen erforderlichen hohen Temperaturbelastbarkeit machen die MINI®-Sicherung besonders empfehlenswert.

Time-Current Characteristics / Schmelzeit-Grenzwerte

% of Rating % des Nennstromes	Opening Time Min / Max (s) Schmelzcharakteristik Min / Max (s)
110	100 hrs. / –
135	0.75 s / 600 s
200	0.15 s / 5 s
350	0.080 s / 0.250 s
600	0.030 s / 0.100 s

Meets SAE J2077

Part Number Artikel-Nr.	Current Rating Nennstrom	Housing Color Kennfarbe	Typ. Voltage Drop Typ. Spannungsfall	Cold Resistance Kaltwiderstand	I ² t
0297002_	2 A	Grey	171 mV	55.60 mΩ	2.8 A ² s
0297003_	3 A	Purple	153 mV	33.75 mΩ	9.4 A ² s
0297004_	4 A	Pink	121 mV	23.48 mΩ	17 A ² s
0297005_	5 A	Brown	129 mV	17.75 mΩ	25 A ² s
029707.5_	7.5 A	Dark Brown	135 mV	10.85 mΩ	68 A ² s
0297010_	10 A	Red	108 mV	7.42 mΩ	93 A ² s
0297015_	15 A	Blue	98 mV	4.58 mΩ	270 A ² s
0297020_	20 A	Yellow	96 mV	3.21 mΩ	380 A ² s
0297025_	25 A	White	86 mV	2.36 mΩ	625 A ² s
0297030_	30 A	Green	87 mV	1.85 mΩ	1130 A ² s

Last figure of part number = packaging code, see Section "Packaging Index," pg. 157.
 Corresponding holder see Section "Fuse Holders."

MINI® Blade Fuse Rated 32V

Dimensions in mm / Maße in mm

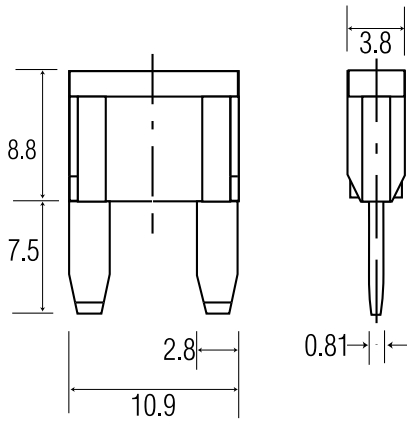

MINI Fuse Temperature Derating Curve

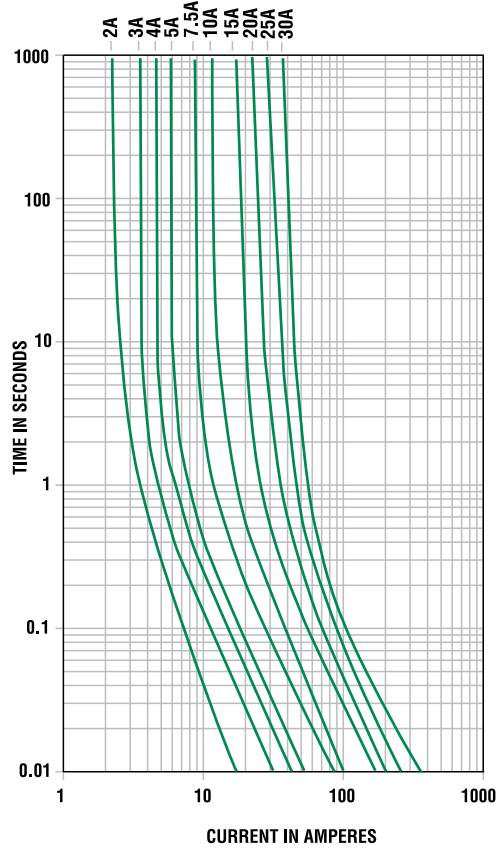
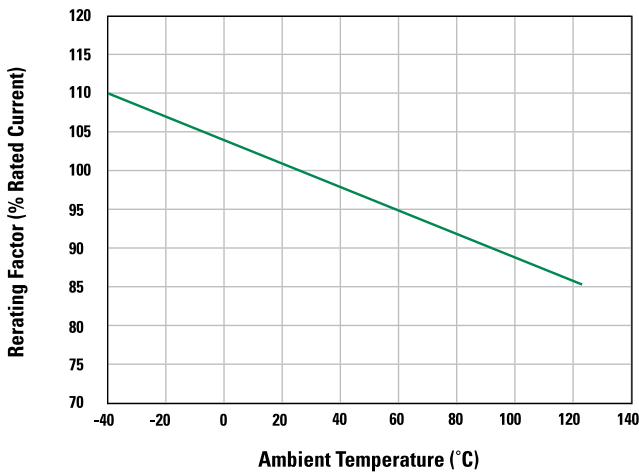

Blade Fuses

See Section Specialty Products for Resistors, Diodes, and Shunts.