

Distributed by:

JAMECO[®]
ELECTRONICS

www.Jameco.com ♦ 1-800-831-4242

The content and copyrights of the attached
material are the property of its owner.

Jameco Part Number 180021

1003 Series

D-SUB Dip Straight Type

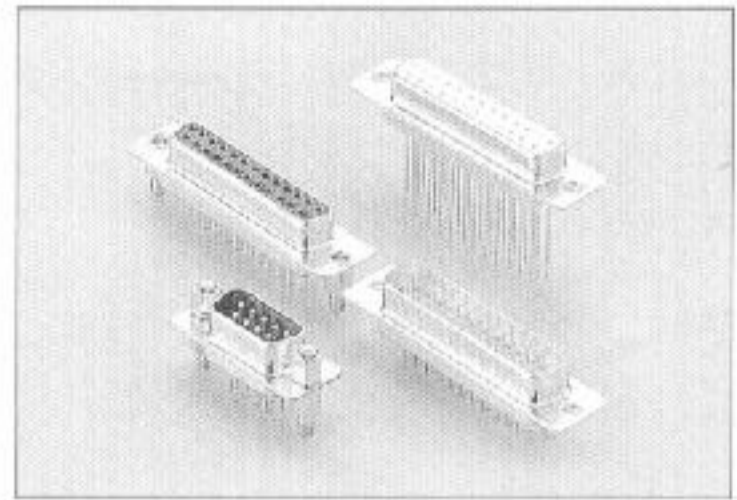

(ROHS)

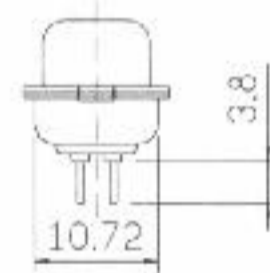
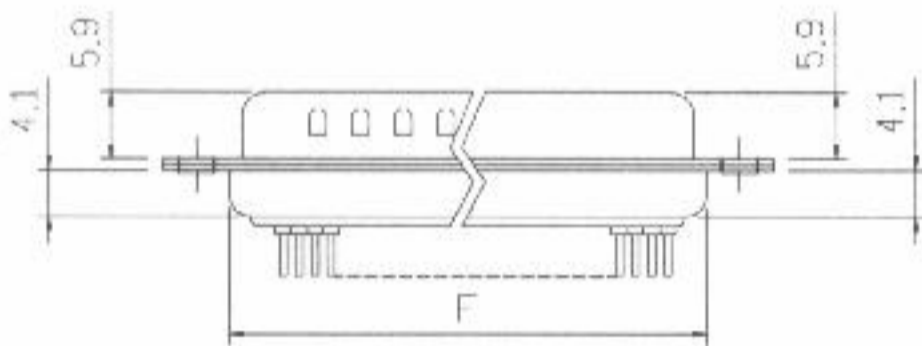
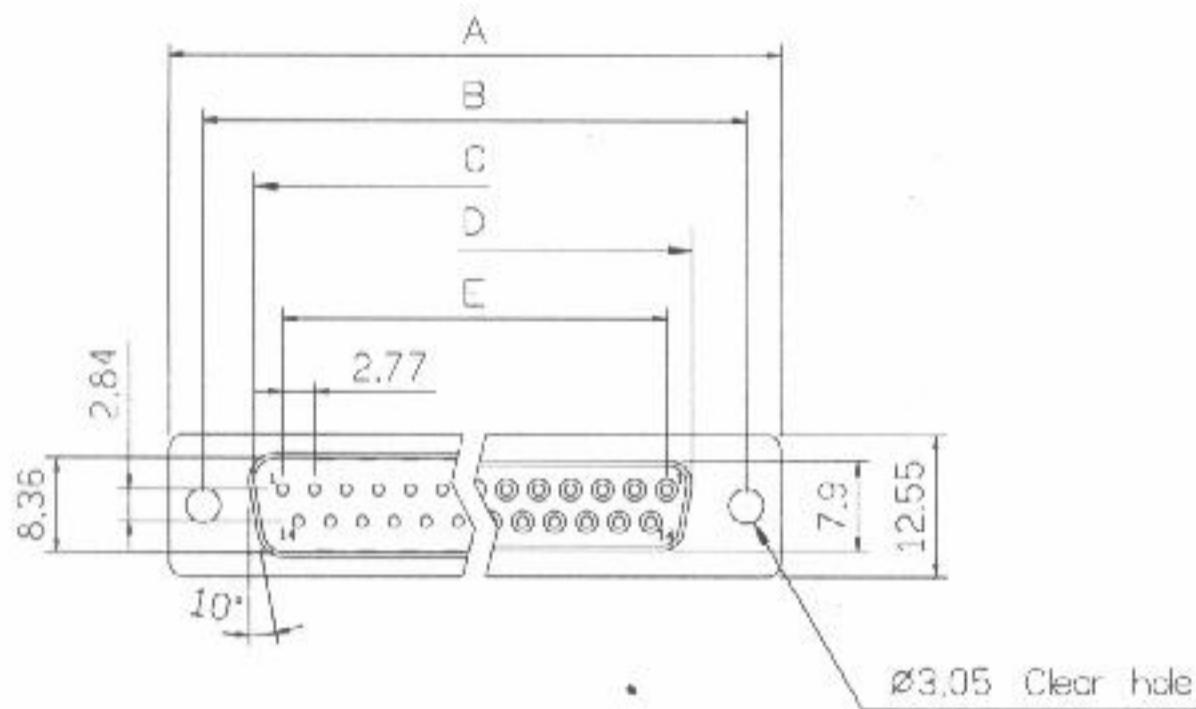

Dimensions

Positions	A	B	C	D	E	F
9	30.81	24.99	16.92	16.33	11.08	19.20
15	39.14	33.32	25.50	24.66	19.39	27.70
25	53.04	47.04	38.96	38.38	33.24	41.10
37	69.32	63.50	55.42	54.84	49.86	57.30

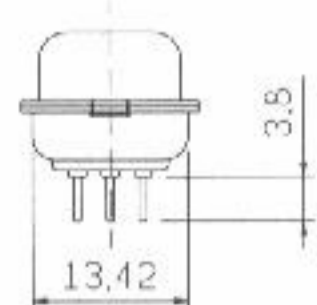
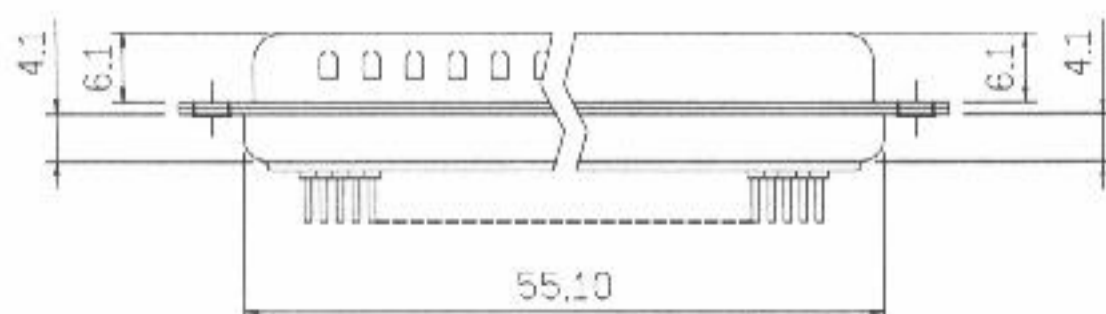
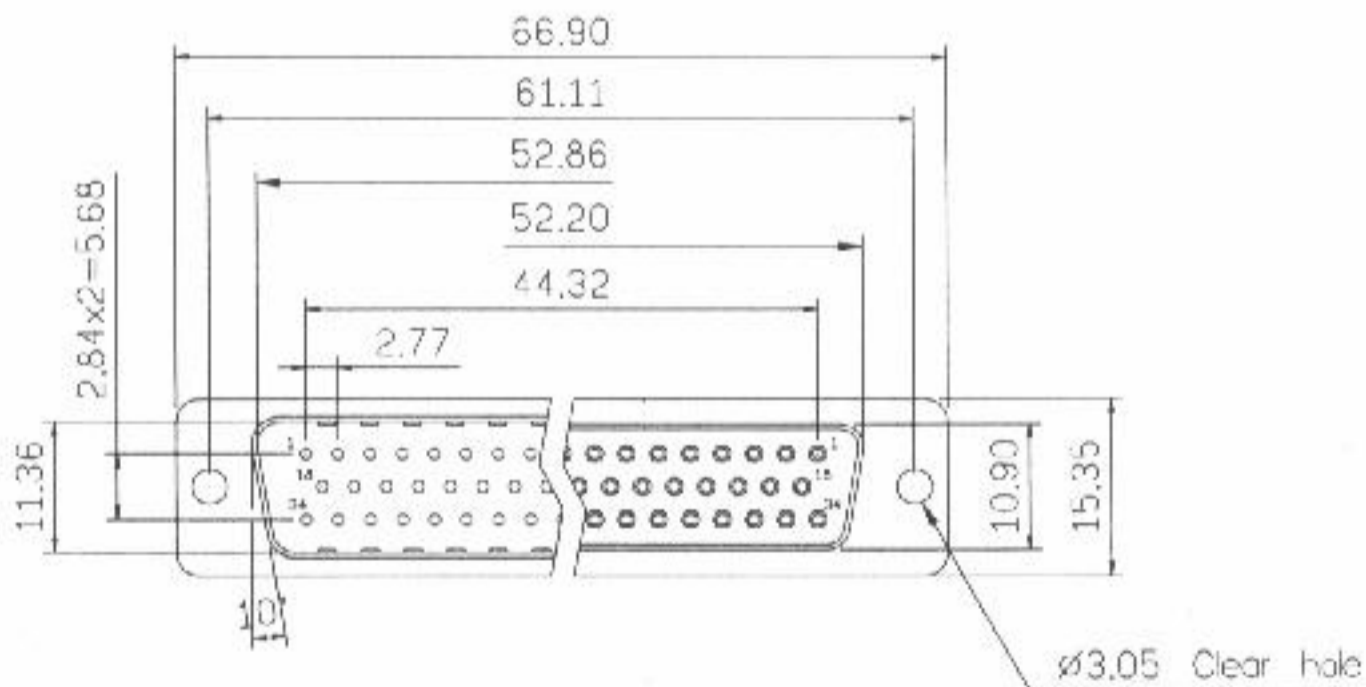

50 Positions

Product Specification

Material

Insulator : Glass-Filled Thermoplastic
PBT,UL 94V-0 rated

Contact : Brass or Phosphor Bronze

Shell : Steel, 100u" Tin Over 50u" min
Nickel.

Clinch Nut: Brass, 100u" min Nickel
Plated.

Boardlock : Brass, 100u" min Nickel
Plated.

Screwlock : Brass, 100u" min Nickel
Plated.

Electrical

Contact Resistance : 20 milliohms
Max at 1 AMP DC.

Insulation Resistance : 1000
megohms at 500 VDC

Dielectric Withstanding Voltage :
1000 VAC/rms 60Hz for 1 minute

Current Rating : 5 AMP

Volatge Rating : 250 VAC/rms
60Hz