

- High sensitivity: 150 mW nominal power consumption with 96 mW pickup power
- Small size at 10 H x 7.5 W x 12.5 L mm (0.394 H x 0.295 W x 0.492 L in)
- Conforms to FCC part 68 voltage surge
- Fully-sealed construction
- Ideal for use in telecommunications, security, and computer/peripheral equipment
- Available in PCB through-hole, SMT gullwing; high ambient versions and high dielectric versions

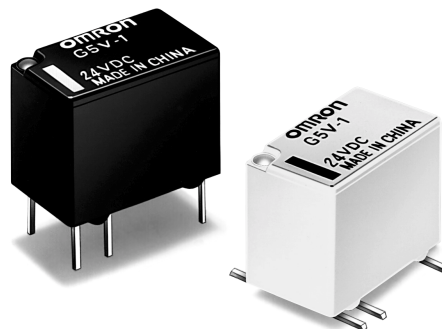

Ordering Information

To Order: Select the part number and add the desired coil voltage rating (e.g., G5V-1-DC12).

Terminal	Type	Contact form	Contact type	Construction	Part number
PCB through-hole	Standard	SPDT	Single crossbar	Fully sealed	G5V-1
	Special pickup				G5V-1-2
	High dielectric				G5V-1-HTY
Surface mount gullwing	Standard				G5V-1F
	High dielectric				G5V-1F-Y

Note: Reflow solder process version is also available in PCB through-hole configuration. Please consult your local Omron sales representative for more information.

Specifications

CONTACT DATA

Load	Resistive load (p.f. = 1)	Inductive load (p.f. = 0.4, L/R = 7ms)
Rated load	0.50 A at 125 VAC, 1 A 24 VDC	
Contact material	Ag (Au clad)	
Carry current	2 A	
Max. operating voltage	125 VAC, 60 VDC	
Max. operating current	1 A	
Max. switching capacity	62.50 VA, 30W	
Min. permissible load	1 mA, 5 VDC	

■ COIL DATA (G5V-1, G5V-1-2)

Rated voltage (VDC)	Rated current (mA)	Coil resistance (Ω)	Coil inductance (Ref. value) (H)		Pick-up voltage	Dropout voltage	Maximum voltage	Power consumption (mW)
			Armature OFF	Armature ON				
3	50	60	0.11	0.05	80% 70% (special pickup)	10% min.	200% at 55°C (131°F) 160% at 70°C (158°F)	Approx. 150
5	30	166.70	0.29	0.15				
6	25	240	0.41	0.20				
9	16.70	540	0.93	0.45				
12	12.50	960	1.63	0.85				
24	6.30	3,840	6.61	3.48				

Note: 1. The rated current and coil resistance are measured at a coil temperature of 23°C (73°F) with a tolerance of $\pm 10\%$.
2. The operating characteristics are measured at a coil temperature of 23°C (73°F).

■ COIL DATA (G5V-1-HTY, G5V-1F, G5V-1F-Y)

Rated voltage (VDC)	Rated current (mA)	Coil resistance (Ω)	Coil inductance (Ref. value) (H)		Pick-up voltage	Dropout voltage	Maximum voltage	Power consumption (mW)
			Armature OFF	Armature ON				
5	30	166.70	0.29	0.15	80% max.	10% min.	200% at 55°C (131°F) 160% at 70°C (158°F)	Approx. 150
12	12.50	960	1.63	0.85				Approx. 200
24	8.3	2,880	4.95	2.61				

Note: 1. The rated current and coil resistance are measured at a coil temperature of 23°C (73°F) with a tolerance of $\pm 10\%$.
2. The operating characteristics are measured at a coil temperature of 23°C (73°F).

■ CHARACTERISTICS

Contact resistance		100 m Ω max.
Operate time		5 ms max. (mean value: approx. 2.50 ms)
Release time		5 ms max. (mean value: approx. 0.90 ms)
Bounce time		5 ms max. (mean value: approx. 0.17 ms)
Operating frequency	Mechanical	36,000 operations/hour
	Electrical	1,800 operations/hour
Insulation resistance		1,000 M Ω min. (at 500 VDC)
Dielectric strength		1,000 VAC, 50/60 Hz for 1 minute between coil and contacts 1,500 VAC, 50/60 Hz for 1 minute between coil and contacts (high dielectric versions) 400 VAC, 50/60 Hz for 1 minute between contacts of same polarity
Surge withstand voltage		1,500 V 10 X 160 μ s (conforms to FCC Part 68)
Vibration	Mechanical durability	10 to 55 Hz, 3.30 mm (0.13 in) double amplitude
	Malfunction durability	
Shock	Mechanical durability	1,000 m/s ² (approx. 100 G)
	Malfunction durability	100 m/s ² (approx. 10 G)
Ambient temperature		-30°C to 70°C (-22°F to 158°F) for standard and special pickup PCB through-hole version; -40°C to 70°C (-40°F to 158°F) for surface mount versions
Humidity		35% to 85% RH
Service life	Mechanical	5 million operations min. (at 36,000 operations/hour)
	Electrical	See "Characteristic Data"
Weight		2.20 g (0.08 oz)

Note: Data shown are of initial value.

■ CHARACTERISTIC DATA

Maximum switching capacity

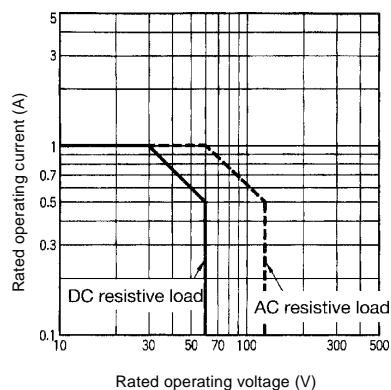

Ambient temperature vs. maximum voltage (reference only)

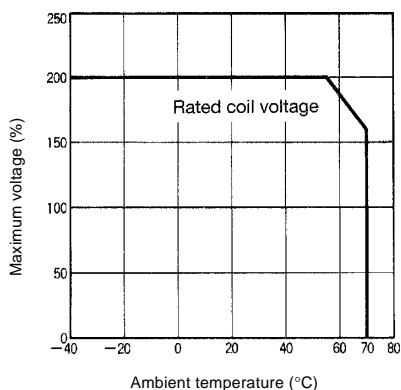

Electrical service life

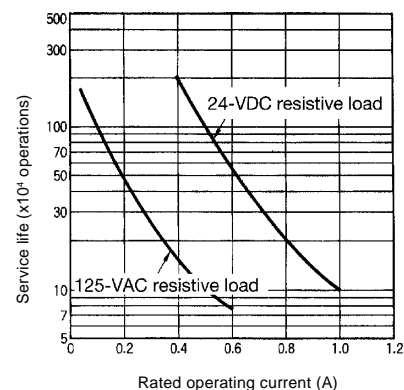

Dimensions

Unit: mm (inch)

■ RELAYS

G5V-1, G5V-1-2

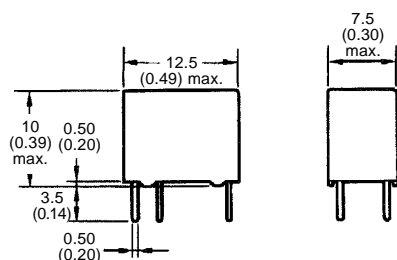

Terminal arrangement/ Internal connections (bottom view)

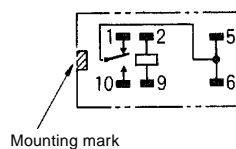

Mounting holes (bottom view)

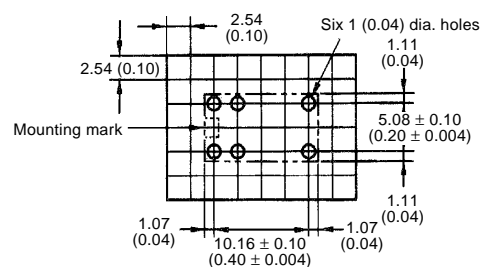

G5V-1-HTY

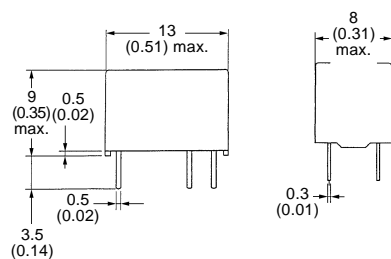

Terminal arrangement/ Internal connections (bottom view)

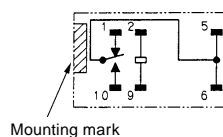

Mounting holes (bottom view)

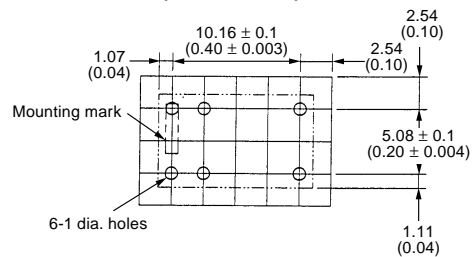

G5V-1F, G5V-1F-Y

Terminal arrangement/
Internal connections
(top view)

Mounting pads
(top view)

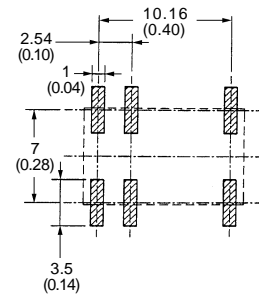
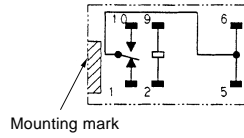
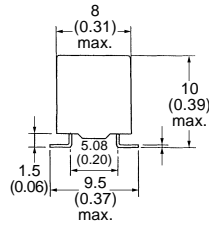
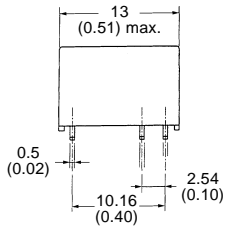

- Note: 1. and indicate mounting orientation marks.
2. A tolerance of ± 0.10 (0.004) applies to the above dimensions.

REEL DIMENSIONS (FOR SURFACE MOUNT VERSIONS ONLY)

Unit: mm (inch)

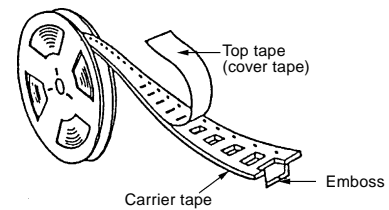
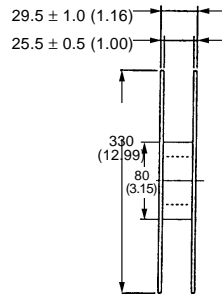
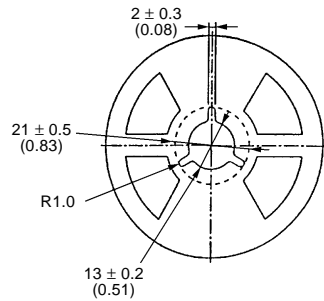

Tape

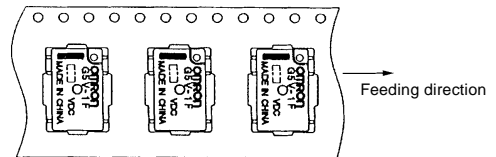
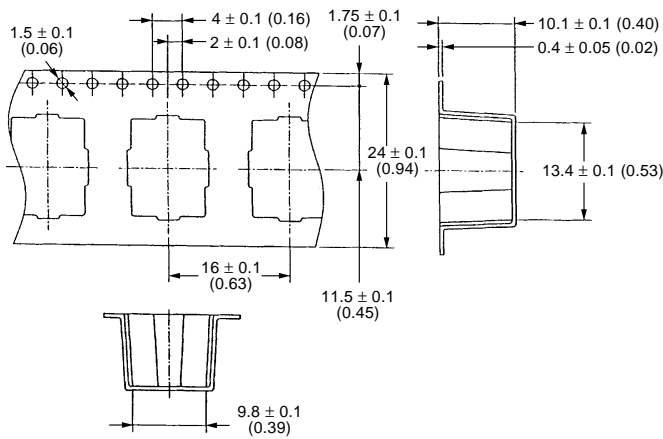

■ APPROVALS

UL (File No. E41515)/CSA (File No. LR24825)

Type	Contact form	Coil rating	Contact ratings
G5V-1	SPDT	3 to 24 VDC	0.5 A, 125 VAC
G5V-1-2			0.3 A, 60 VDC
G5V-1F			1.0 A, 30 VDC
G5V-1F-Y			
G5V-1-HTY			

- Note: 1. In the interest of product improvement, specifications are subject to change.
 2. Complies with UL1950 Basic Insulation at 125 V (pollution degree 1 for internal spacings, pollution degree 2 for external spacings).

NOTE: DIMENSIONS ARE SHOWN IN MILLIMETERS. To convert millimeters to inches divide by 25.4.

OMRON

OMRON ELECTRONICS, INC.

One East Commerce Drive
 Schaumburg, IL 60173
1-800-55-OMRON

OMRON CANADA, INC.

885 Milner Avenue
 Scarborough, Ontario M1B 5V8
416-286-6465