

Distributed by:

**JAMECO**<sup>®</sup>  
ELECTRONICS

**www.Jameco.com ♦ 1-800-831-4242**

The content and copyrights of the attached  
material are the property of its owner.

Jameco Part Number 1885736

## FLAT CHIP THICK FILM (1% • 0.5%) PRECISION RK73H

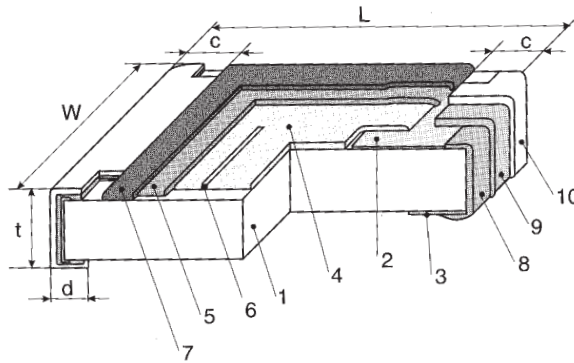

### STRUCTURE

- |    |                            |           |
|----|----------------------------|-----------|
| 1  | Ceramic substrate          |           |
| 2  | Top termination (Ag Pd)    | ~ 11 μm   |
| 3  | Bottom termination (Ag Pd) | ~ 11 μm   |
| 4  | Resistive layer            | ~ 11 μm   |
| 5  | Glass layer                | ~ 11 μm   |
| 6  | Trimming cut               |           |
| 7  | Protective layer           | ~ 25 μm   |
| 8  | End termination            | ~ 0.05 μm |
| 9  | Diffusion barrier (Ni)     | ~ 8 μm    |
| 10 | Solder plating             | ~ 8 μm    |

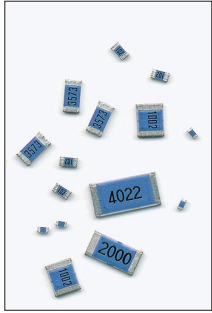

### IDENTIFICATION

TYPE	COATING COLOR	MARKING
RK73H 1H	Black	None
RK73H 1E		None
RK73H 1J	Blue	Black, 3 digits (E24) None (E96)
RK73H 2A ... RK73H 3A		Black, 4 digits

### TYPE DESIGNATION (HOW TO ORDER)

Old Part No.	<b>RK73H</b>	<b>1J</b>	<b>F</b>	<b>TD</b>	<b>22K1</b>		
New Part No.	<b>RK73H</b>	<b>1J</b>		<b>TD</b>	<b>2212</b>	<b>F</b>	
	PRODUCT CODE	STYLE	TOLERANCE	TERMINATION SURFACE MATERIAL T: Sn L: Sn/Pb	TAPING*	NOMINAL RESISTANCE 4 digits	TOLERANCE

### FEATURES

- RuO<sub>2</sub> thick film resistor element
- Anti-leaching nickel barrier terminations
- Excellent heat resistance and moisture resistance are ensured by the use of metal glaze thick film
- Rated ambient temperature: +70° C
- Taping according to IEC-60 286-3
- Meets or exceeds IEC 60 115, CECC 40 401-802
- Suitable for reflow and wave soldering

### DIMENSIONS (mm)

SIZE	TYPE	L	W	c	d	t
0201	RK73H 1H	0.6 ± 0.03	0.3 ± 0.03	0.1 ± 0.05	0.15 ± 0.05	0.23 ± 0.03
0402	RK73H 1E	1.0 ± 0.05	0.5 ± 0.05	0.2 ± 0.1	0.25 ± 0.05	0.35 ± 0.05
0603	RK73H 1J	1.6 ± 0.2	0.8 ± 0.1	0.3 ± 0.1	0.3 ± 0.1	0.45 ± 0.1
0805	RK73H 2A	2.0 ± 0.2	1.25 ± 0.1	0.4 ± 0.2	0.3 ± 0.1	0.5 ± 0.1
1206	RK73H 2B	3.2 ± 0.2	1.6 ± 0.2			
1210	RK73H 2E		2.6 ± 0.2		0.4 ± 0.1	0.6 ± 0.1
2010	RK73H 2H	5.0 ± 0.2	2.5 ± 0.2	0.5 ± 0.3		
2512	RK73H 3A	6.3 ± 0.2	3.1 ± 0.2			

### RATING

SIZE	TYPE	T.C.R. (ppm/K)	POWER RATING	MAX. WORKING VOLTAGE	MAX. OVERLOAD VOLTAGE	RESISTANCE RANGE (E24 • E96)		OPERATING TEMPERATURE RANGE
						D (±0.5%)	F (±1%)	
<b>NEW</b> 0201	RK73H 1H	± 200	0.05 W	25 V	50 V	—	10 Ω ... 1 MΩ (E24)	-55° C...+125°C*
0402	RK73H 1E	± 200	0.063 W	50 V	100 V	10 Ω ... 976 kΩ	1.02 MΩ ... 10 MΩ	
0603	RK73H 1J	± 400	0.1 W	150 V	200 V	10 Ω ... 976 kΩ	10 Ω ... 1 MΩ	-55° C...+155°C*
0805	RK73H 2A	± 400	0.125 W	200 V	400 V	10 Ω ... 976 kΩ	10 Ω ... 1 MΩ	
1206	RK73H 2B	± 200	0.25 W	200 V	400 V	10 Ω ... 976 kΩ	1.02 MΩ ... 5.6 MΩ	-55°C...+125°C*
1210	RK73H 2E	± 400	0.5 W	200 V	400 V	10 Ω ... 976 kΩ	10 Ω ... 1 MΩ	
2010	RK73H 2H	± 200	0.75 W	200 V	400 V	10 Ω ... 976 kΩ	1.02 MΩ ... 5.6 MΩ	-55°C...+125°C*
2512	RK73H 3A	± 100	1 W	200 V	400 V	10 Ω ... 976 kΩ	10 Ω ... 1 MΩ	

\* Please note derating diagram

**FLAT CHIP  
THICK FILM  
RK73**

**PERFORMANCE**

TEST	TEST CONDITIONS	TYP. TEST RESULTS
Life test at 70° C rated power (P <sub>70</sub> )	IEC 115-1 4.25.1 70° C ± 3° C, 1000 h; 1.5 h On / 0.5 h Off cycle	± (1% · R + 0.05 Ω)
Rapid change of temperature	IEC 115-1 4.19 - 55° C (30 min) / + 125° C (30 min); 5 cycles	± (0.5% · R + 0.1 Ω)
Damp heat steady state	IEC 115-1 4.24 56 days at 40° C and 93% relative humidity	± (1% · R + 0.05 Ω)
Endurance at 125° C	IEC 115-1 4.25.3 + 125° C / 1000 h	± (1% · R + 0.05 Ω)
Short time overload	IEC 115-1 4.13 6.25 x rated power for 5 sec., but smaller 2.5 x U <sub>max</sub>	± (1% · R + 0.05 Ω)
T.C.R.	IEC 115-1 4.8 Cycle: + 25° C / - 55° C / + 25° C / 125° C / + 25° C	Within specified T.C.R.
Bending test	IEC 115-1 4.31 Bending: 5 mm (1J, 2A, 2B); 3 mm (1H, 1E); 2 mm (2E, 2H, 3A)	± (0.5% · R + 0.05 Ω)
Solderability	IEC 68-2-20 235 ± 5° C / 2 ± 0.5 sec.	Terminations > 95% covered with new solder
Resistance to soldering heat	IEC 115-1 4.18 10 ± 1 sec. at 260 ± 5° C solder bath temperature	± (0.5% · R + 0.05 Ω)

**DERATING CURVE**

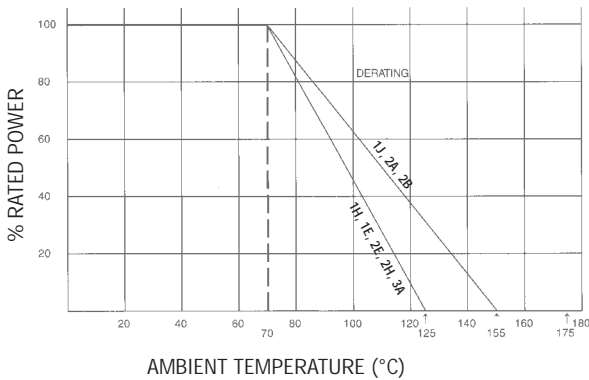

**SURFACE TEMPERATURE RISE**

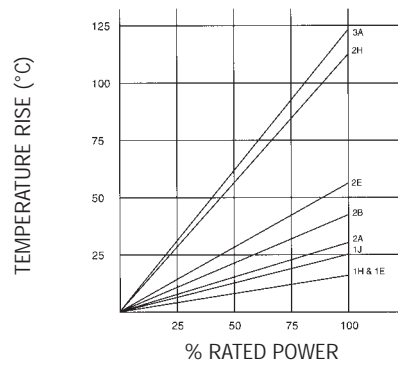

**ONE-PULSE LIMITING ELECTRIC POWER**

KOA RK73 Flat Chip Resistors

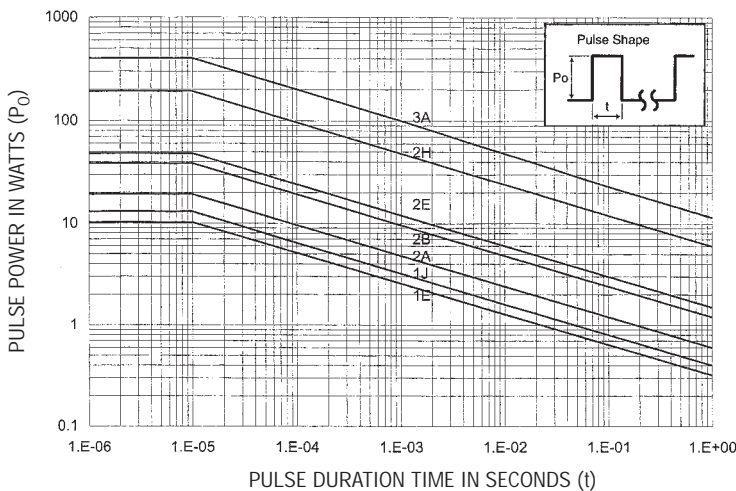

Specifications given herein may be changed at any time without prior notice. Please confirm technical specifications before you order and/or use.

## RECOMMENDED PAD DIMENSIONS

### FOR REFLOW SOLDERING

TYPE	STYLE	DIMENSIONS (mm)				
		COMPONENT SIZE	A	B	C	D
RK73	1H	0.6 x 0.3	0.25	0.7	0.3	0.225
SG73	1E	1.0 x 0.5	0.5	1.3	0.3	0.4
RN73	1J	1.6 x 0.8	1.0	2.0	0.6	0.5
SR73	1J	1.6 x 0.8	1.0	2.0	0.6	0.5
RK73N	2A	2.0 x 1.25	1.3	2.5	1.05	0.6
LT73	2A	2.0 x 1.25	1.3	2.5	1.05	0.6
NT73	2B	3.2 x 1.6	2.2	4.0	1.4	0.9
PT72	2B	3.2 x 1.6	2.2	4.0	1.4	0.9
LA73	2E	3.2 x 2.5	2.2	4.0	2.3	0.9
CR73	2H	5.0 x 2.5	3.5	6.3	2.3	1.4
RF73	2H	5.0 x 2.5	3.5	6.3	2.3	1.4
KL73	3A	6.4 x 3.2	4.6	8.0	3.0	1.7

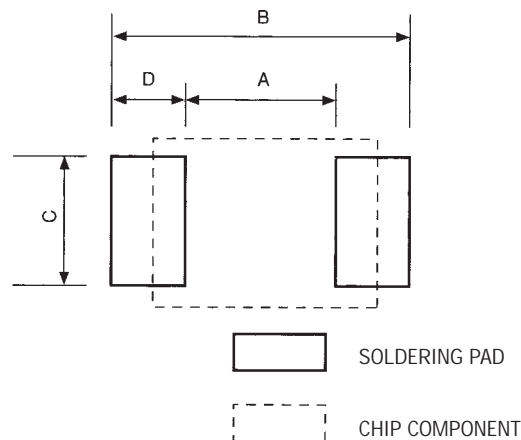

### FOR WAVE SOLDERING

TYPE	STYLE	DIMENSIONS (mm)				
		COMPONENT SIZE	A	B	C	D
RK73	1E	1.0 x 0.5	0.5	1.5	0.5	0.5
SG73	1J	1.6 x 0.8	1.0	2.4	0.8	0.7
RN73	1J	1.6 x 0.8	1.0	2.4	0.8	0.7
SR73	2A	2.0 x 1.25	1.3	3.1	1.25	0.9
RK73N	2A	2.0 x 1.25	1.3	3.1	1.25	0.9
LT73	2B	3.2 x 1.6	2.2	4.4	1.6	1.1
NT73	2B	3.2 x 1.6	2.2	4.4	1.6	1.1
LA73	2E	3.2 x 2.5	2.2	4.4	2.5	1.1
CR73	2H	5.0 x 2.5	3.5	6.3	2.5	1.4
RF73	2H	5.0 x 2.5	3.5	6.3	2.5	1.4
KL73	3A	6.4 x 3.2	4.6	8.0	3.2	1.7

## RECOMMENDED IR PROFILE (FLAT TYPE COMPONENTS)

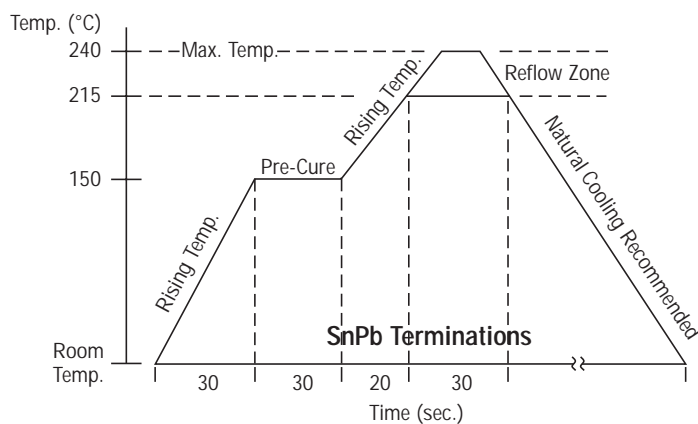

## RECOMMENDED WAVE SOLDER PROFILE (FLAT TYPE COMPONENTS)

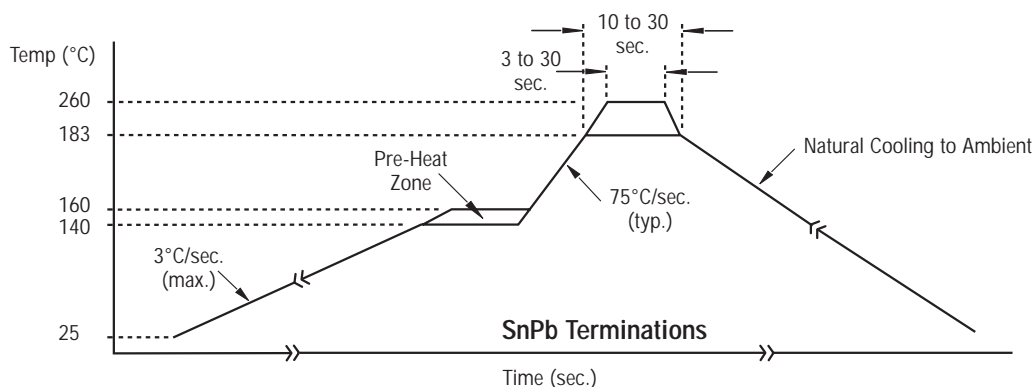

Specifications given herein may be changed at any time without prior notice. Please confirm technical specifications before you order and/or use.