

P1: M-001

P2: M-052A

Customer No.: No.:

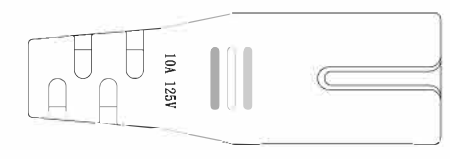
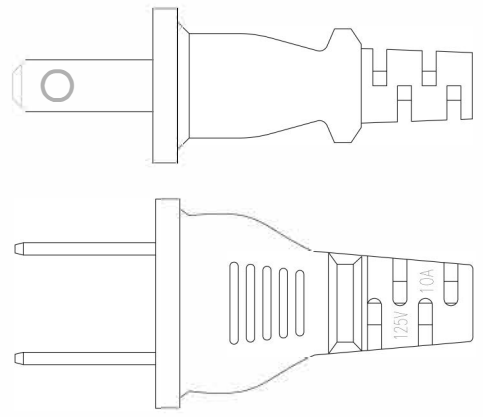
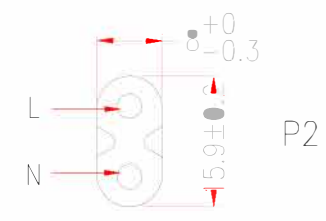
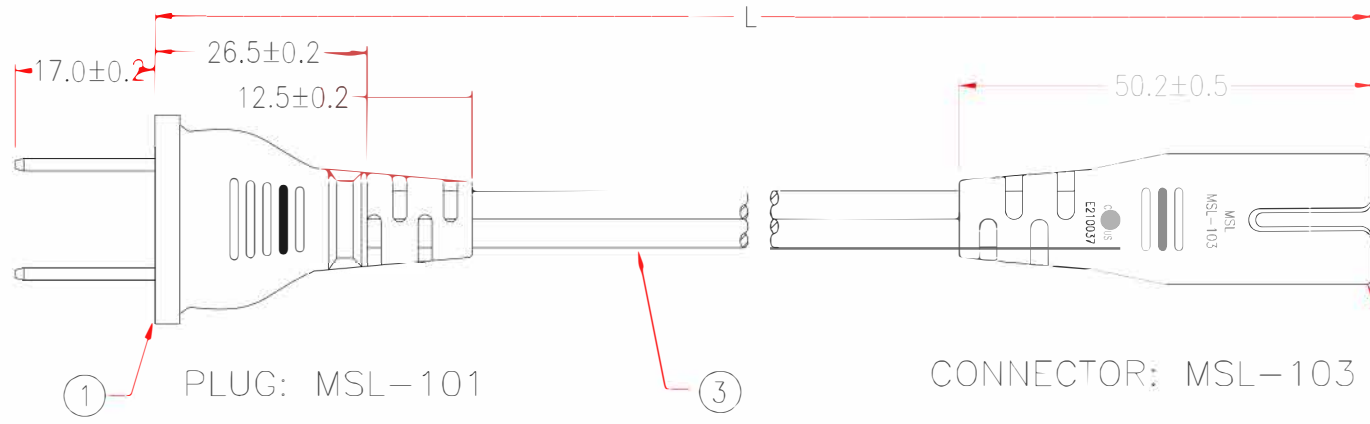
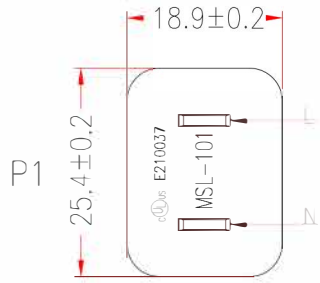

PACKING A: <3M

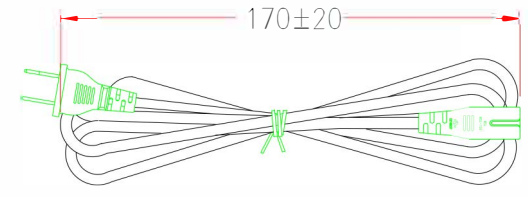

PACKING B: >3M

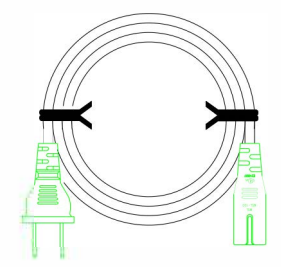

P1,P2: US E210037

CABLE MARKING:

(UL) SPT-2 2/C 18AWG(0.824MM<sup>2</sup>) VW-1 105°C 300V E204978 CSA  
 SPT-2 2/C 0.824MM<sup>2</sup>(18AWG) FT2 105°C 300V 204790 MSL



NOTE: All relevant materials are complied with RoHS directive .  
 THE CABLE MARKING IS CONCAVE LETTERING MOULD

3	UL SPT-2 18AWG x 2C, OD 3.5*6.9mm, JACKET BLACK, DRAWING No. EPSPT001802C-050	H5TA04-0304K09	L-20mm	M304
	MOLDED PVC 35P, COLOR BLACK	H1BC02-0304K09		M304
2	2.35 BRACKET: YS-031, COLOR BLACK	A1QC03-0767K09	1	M767
	2.35 TERMINAL: 98714PS-0	A1QB05-0257	2	M257
1	MOLDED PVC 35P, COLOR BLACK	H1BC02-0304K09		M304
	BRACKET: YS-001	A1QC02-0767	1	M767
	TERMINAL: 98661BS-1	A1QB01-0257	2	M257
No.	DESCRIPTION		Q'TY	Supplier

APPROVED					Cable Length Unless Other Spec. Tolerances: 0~200mm ±10mm 201~1000mm ±20mm 1001~1500mm ±25mm 1501~2100mm ±30mm 2100mm± ±40mm
CHECKED	HU	08/JUN/18	DRAWN NAME	POWER SUPPLY CORDS & CORDS SETS	
DRAWING	XIAO	08/JUN/18	PRODUCT NO.	<b>10W1-132XX-NE</b>	
					UNIT: mm

NOTE: Cable Length Unless Otherwise Spec. Tolerances: Under 6FT ±25mm; Another ±50mm