

Distributed by:

JAMECO[®]
ELECTRONICS

www.Jameco.com ♦ 1-800-831-4242

The content and copyrights of the attached
material are the property of its owner.

Jameco Part Number 1938439

Section 3: Introduction



Foreword

AVX offers a broad line of solid Tantalum capacitors in a wide range of sizes, styles, and ratings to meet any design needs. This catalog combines into one source AVX's leaded tantalum capacitor information from its worldwide tantalum operations.

The TAP is rated for use from -55°C to +85°C at rated voltage and up to +125°C with voltage derating. There are three preferred wire forms to choose from which are available on tape and reel, and in bulk for hand insertion.

Four sizes of molded axials, the TAR series, are also available. The TAR is fully marked and available on tape and reel for high speed insertion. The TAA is a hermetically sealed series also with four case sizes available.

AVX has a complete tantalum applications service available for use by all our customers. With the capability to prototype and mass produce solid tantalum capacitors in special configurations, almost any design need can be fulfilled. And if the customer requirements are outside our standard testing, AVX will work with you to define and implement a test or screening plan.

AVX is determined to become the world leader in tantalum capacitor technology and has made, and is continuing to make, significant investments in equipment and research to reach that end. We believe that the investment has paid off with the devices shown on the following pages.

Dipped Radial Capacitors

SOLID TANTALUM RESIN DIPPED SERIES TAP

The TAP resin dipped series of miniature tantalum capacitors is available for individual needs in both commercial and professional applications. From computers to automotive to industrial, AVX has a dipped radial for almost any application.

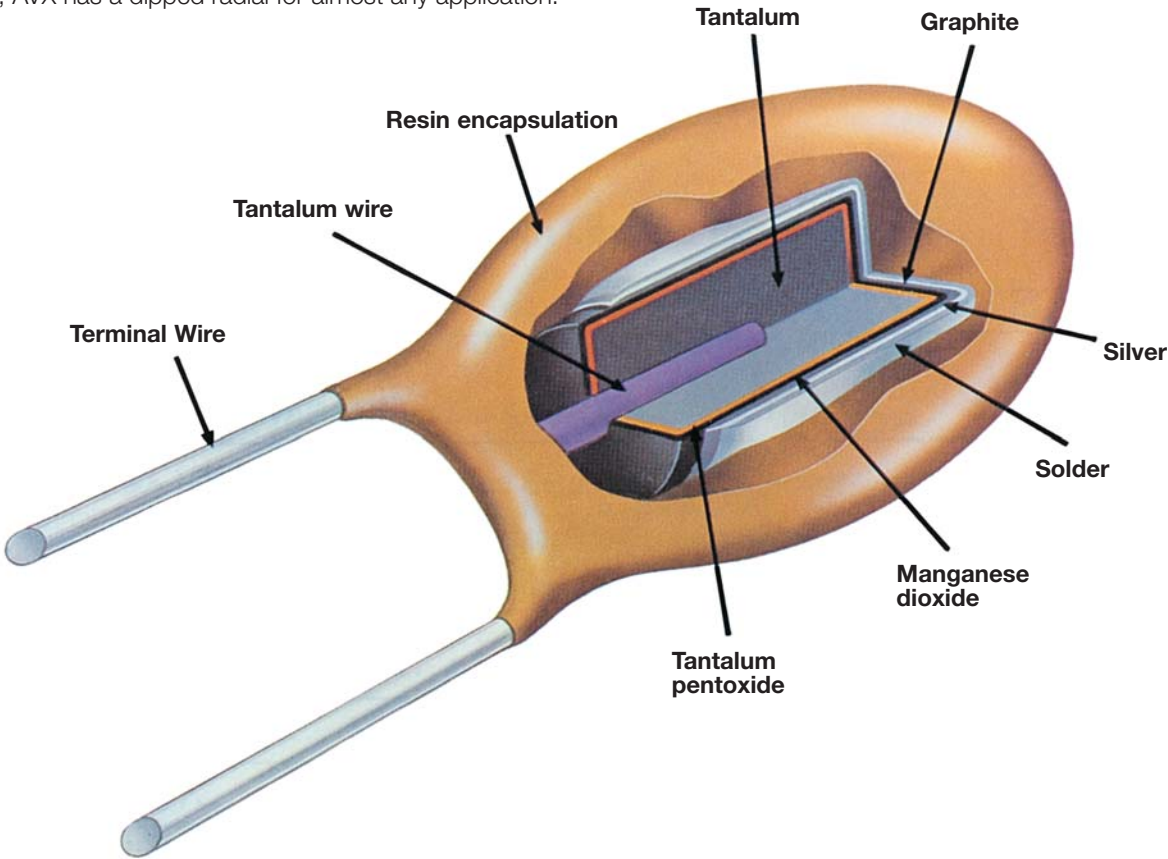

Dipped Radial Capacitors



Wire Form Outline

SOLID TANTALUM RESIN DIPPED TAP

Preferred Wire Forms

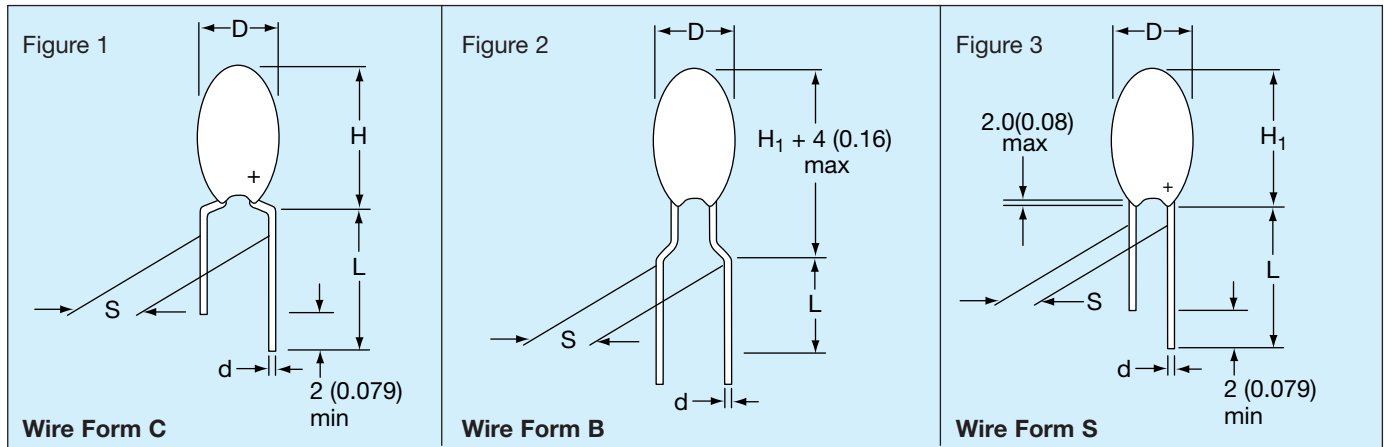

Non-Preferred Wire Forms (Not recommended for new designs)

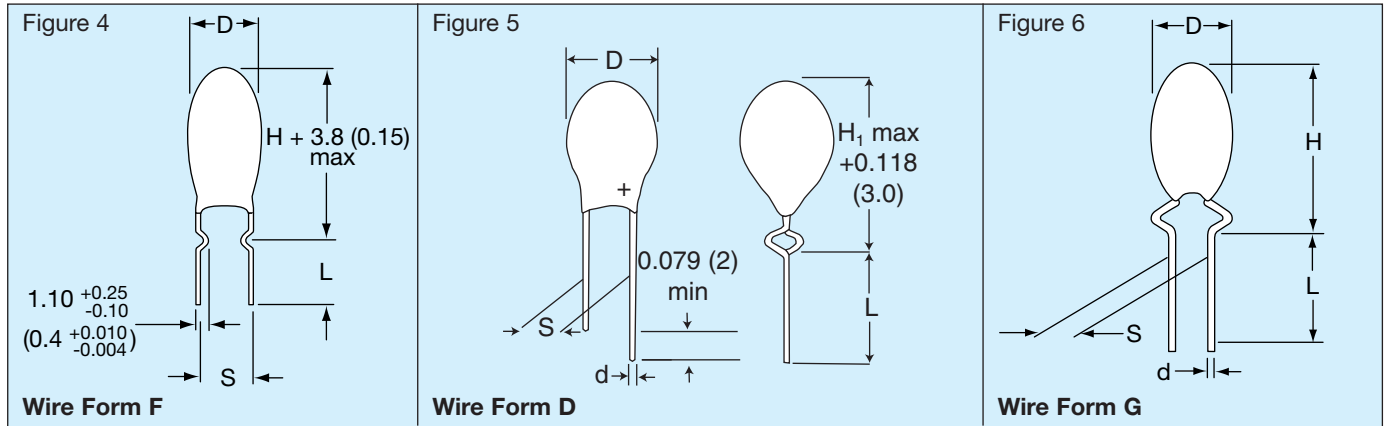

DIMENSIONS

millimeters (inches)

Wire Form	Figure	Case Size	L (see note 1)	S	d	Packaging Suffixes Available*
-----------	--------	-----------	----------------	---	---	-------------------------------

Preferred Wire Forms

C	Figure 1	A - R*	16.0±4.00 (0.630±0.160)	5.00±1.00 (0.200±0.040)	0.50±0.05 (0.020±0.002)	CCS Bulk CRW Tape/Reel CRS Tape/Ammo
B	Figure 2	A - J*	16.0±4.00 (0.630±0.160)	5.00±1.00 (0.200±0.040)	0.50±0.05 (0.020±0.002)	BRW Tape/Reel BRS Tape/Ammo
S	Figure 3	A - J*	16.0±4.00 (0.630±0.160)	2.50±0.50 (0.100±0.020)	0.50±0.05 (0.020±0.002)	SCS Bulk SRW Tape/Reel SRS Tape/Ammo

Non-Preferred Wire Forms (Not recommended for new designs)

F	Figure 4	A - R	3.90±0.75 (0.155±0.030)	5.00±0.50 (0.200±0.020)	0.50±0.05 (0.020±0.002)	FCS Bulk
D	Figure 5	A - H*	16.0±4.00 (0.630±0.160)	2.50±0.75 (0.100±0.020)	0.50±0.05 (0.020±0.002)	DCS Bulk DTW Tape/Reel DTS Tape/Ammo
G	Figure 6	A - J	16.0±4.00 (0.630±0.160)	3.18±0.50 (0.125±0.020)	0.50±0.05 (0.020±0.002)	GSB Bulk
H	Similar to Figure 1	A - R	16.0±4.00 (0.630±0.160)	6.35±1.00 (0.250±0.040)	0.50±0.05 (0.020±0.002)	HSB Bulk

Notes: (1) Lead lengths can be supplied to tolerances other than those above and should be specified in the ordering information.

(2) For D, H, and H₁ dimensions, refer to individual product on following pages.

* For case size availability in tape and reel, please refer to pages 134-135.

Dipped Radial Capacitors



TAP Series

SOLID TANTALUM RESIN DIPPED CAPACITORS

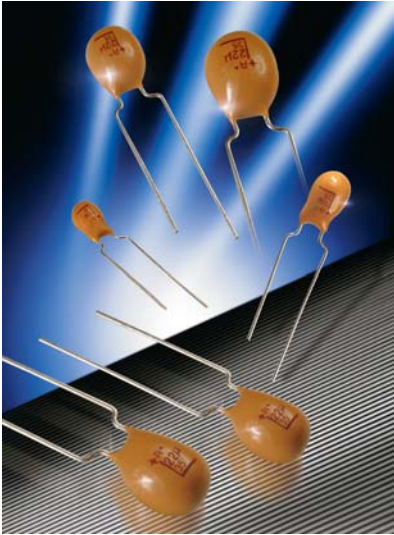

TAP is a professional grade device manufactured with a flame retardant coating and featuring low leakage current and impedance, very small physical sizes and exceptional temperature stability. It is designed and conditioned to operate to +125°C (see page 167 for voltage derating above 85°C) and is available loose or taped and reeled for auto insertion. The 15 case sizes with wide capacitance and working voltage ranges means the TAP can accommodate almost any application.

MAXIMUM CASE DIMENSIONS: millimeters (inches)

Wire Case	C, F, G, H H	B, S, D *H ₁	D
A	8.50 (0.330)	7.00 (0.280)	4.50 (0.180)
B	9.00 (0.350)	7.50 (0.300)	4.50 (0.180)
C	10.0 (0.390)	8.50 (0.330)	5.00 (0.200)
D	10.5 (0.410)	9.00 (0.350)	5.00 (0.200)
E	10.5 (0.410)	9.00 (0.350)	5.50 (0.220)
F	11.5 (0.450)	10.0 (0.390)	6.00 (0.240)
G	11.5 (0.450)	10.0 (0.390)	6.50 (0.260)
H	12.0 (0.470)	10.5 (0.410)	7.00 (0.280)
J	13.0 (0.510)	11.5 (0.450)	8.00 (0.310)
K	14.0 (0.550)	12.5 (0.490)	8.50 (0.330)
L	14.0 (0.550)	12.5 (0.490)	9.00 (0.350)
M	14.5 (0.570)	13.0 (0.510)	9.00 (0.350)
N	16.0 (0.630)		9.00 (0.350)
P	17.0 (0.670)		10.0 (0.390)
R	18.5 (0.730)		10.0 (0.390)

HOW TO ORDER

TAP

Type

475

Capacitance Code
pF code: 1st two digits represent significant figures, 3rd digit represents multiplier (number of zeros to follow)

M

Capacitance Tolerance
K = ±10%
M = ±20%
(For J = ±5% tolerance, please consult factory)

035

Rated DC Voltage

SCS

Suffix indicating wire form and packaging (see page 130)



Dipped Radial Capacitors



TAP Series

TECHNICAL SPECIFICATIONS

Technical Data:		All technical data relate to an ambient temperature of +25°C							
Capacitance Range:		0.1 μ F to 330 μ F							
Capacitance Tolerance:		\pm 20%; \pm 10% (\pm 5% consult your AVX representative for details)							
Rated Voltage DC (V_R)	\leq +85°C:	6.3	10	16	20	25	35	50	
Category Voltage (V_C)	\leq +125°C:	4	6.3	10	13	16	23	33	
Surge Voltage (V_S)	\leq +85°C:	8	13	20	26	33	46	65	
	\leq +125°C:	5	9	12	16	21	28	40	
Temperature Range:		-55°C to +125°C							
Environmental Classification:		55/125/56 (IEC 68-2)							
Dissipation Factor:		\leq 0.04 for C_R 0.1-1.5 μ F							
		\leq 0.06 for C_R 2.2-6.8 μ F							
		\leq 0.08 for C_R 10-68 μ F							
		\leq 0.10 for C_R 100-330 μ F							
Reliability:		1% per 1000 hrs. at 85°C with 0.1 Ω /V series impedance, 60% confidence level.							
Qualification:		CECC 30201 - 032							

Capacitance Range (letter denotes case size)								
Capacitance		Rated voltage DC (V_R)						
μ F	Code	6.3V	10V	16V	20V	25V	35V	50V
0.1	104						A	A
0.15	154						A	A
0.22	224						A	A
0.33	334						A	A
0.47	474						A	A
0.68	684						A	B
1.0	105				A	A	A	C
1.5	155			A	A	A	A	D
2.2	225		A	A	A	A	B	E
3.3	335	A	A	A	B	B	C	F
4.7	475	A	A	B	C	C	E	G
6.8	685	A	B	C	D	D	F	H
10	106	B	C	D	E	E	F	J
15	156	C	D	E	F	F	H	K
22	226	D	E	F	H	H	K	L
33	336	E	F	F	J	J	M	
47	476	F	G	J	K	M	N	
68	686	G	H	L	N	N		
100	107	H	K	N	N			
150	157	K	N	N				
220	227	M	P	R				
330	337	P	R					

Values outside this standard range may be available on request.
 AVX reserves the right to supply capacitors to a higher voltage rating, in the same case size, than that ordered.

MARKING

Polarity, capacitance, rated DC voltage, and an "A" (AVX logo) are laser marked on the capacitor body which is made of flame retardant gold epoxy resin with a limiting oxygen index in excess of 30 (ASTM-D-2863).

- Polarity
- Capacitance
- Voltage
- AVX logo
- Tolerance code:
 - \pm 20% = Standard (no marking)
 - \pm 10% = "K" on reverse side of unit
 - \pm 5% = "J" on reverse side of unit

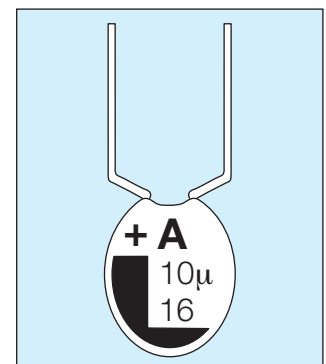

Dipped Radial Capacitors



TAP Series

RATINGS AND PART NUMBER REFERENCE

AVX Part No.	Case Size	Capacitance μF	DCL (μA) Max.	DF % Max.	ESR Max. (Ω) @ 100 kHz
6.3 volt @ 85°C (4 volt @ 125°C)					
TAP 335(+006	A	3.3	0.5	6	13.0
TAP 475(+006	A	4.7	0.5	6	10.0
TAP 685(+006	A	6.8	0.5	6	8.0
TAP 106(+006	B	10	0.5	8	6.0
TAP 156(+006	C	15	0.8	8	5.0
TAP 226(+006	D	22	1.1	8	3.7
TAP 336(+006	E	33	1.7	8	3.0
TAP 476(+006	F	47	2.4	8	2.0
TAP 686(+006	G	68	3.4	8	1.8
TAP 107(+006	H	100	5.0	10	1.6
TAP 157(+006	K	150	7.6	10	0.9
TAP 227(+006	M	220	11.0	10	0.9
TAP 337(+006	P	330	16.6	10	0.7
10 volt @ 85°C (6.3 volt @ 125°C)					
TAP 225(+010	A	2.2	0.5	6	13.0
TAP 335(+010	A	3.3	0.5	6	10.0
TAP 475(+010	A	4.7	0.5	6	8.0
TAP 685(+010	B	6.8	0.5	6	6.0
TAP 106(+010	C	10	0.8	8	5.0
TAP 156(+010	D	15	1.2	8	3.7
TAP 226(+010	E	22	1.7	8	2.7
TAP 336(+010	F	33	2.6	8	2.1
TAP 476(+010	G	47	3.7	8	1.7
TAP 686(+010	H	68	5.4	8	1.3
TAP 107(+010	K	100	8.0	10	1.0
TAP 157(+010	N	150	12.0	10	0.8
TAP 227(+010	P	220	17.6	10	0.6
TAP 337(+010	R	330	20.0	10	0.5
16 volt @ 85°C (10 volt @ 125°C)					
TAP 155(+016	A	1.5	0.5	4	10.0
TAP 225(+016	A	2.2	0.5	6	8.0
TAP 335(+016	A	3.3	0.5	6	6.0
TAP 475(+016	B	4.7	0.6	6	5.0
TAP 685(+016	C	6.8	0.8	6	4.0
TAP 106(+016	D	10	1.2	8	3.2
TAP 156(+016	E	15	1.9	8	2.5
TAP 226(+016	F	22	2.8	8	2.0
TAP 336(+016	F	33	4.2	8	1.6
TAP 476(+016	J	47	6.0	8	1.3
TAP 686(+016	L	68	8.7	8	1.0
TAP 107(+016	N	100	12.8	10	0.8
TAP 157(+016	N	150	19.2	10	0.6
TAP 227(+016	R	220	20.0	10	0.5
20 volt @ 85°C (13 volt @ 125°C)					
TAP 105(+020	A	1.0	0.5	4	10.0
TAP 155(+020	A	1.5	0.5	4	9.0
TAP 225(+020	A	2.2	0.5	6	7.0
TAP 335(+020	B	3.3	0.5	6	5.5
TAP 475(+020	C	4.7	0.7	6	4.5
TAP 685(+020	D	6.8	1.0	6	3.6
TAP 106(+020	E	10	1.6	8	2.9
TAP 156(+020	F	15	2.4	8	2.3
TAP 226(+020	H	22	3.5	8	1.8

AVX Part No.	Case Size	Capacitance μF	DCL (μA) Max.	DF % Max.	ESR Max. (Ω) @ 100 kHz
20 volt @ 85°C (13 volt @ 125°C) continued					
TAP 336(+020	J	33	5.2	8	1.4
TAP 476(+020	K	47	7.5	8	1.2
TAP 686(+020	N	68	10.8	8	0.9
TAP 107(+020	N	100	16.0	10	0.6
25 volt @ 85°C (16 volt @ 125°C)					
TAP 105(+025	A	1.0	0.5	4	10.0
TAP 155(+025	A	1.5	0.5	4	8.0
TAP 225(+025	A	2.2	0.5	6	6.0
TAP 335(+025	B	3.3	0.6	6	5.0
TAP 475(+025	C	4.7	0.9	6	4.0
TAP 685(+025	D	6.8	1.3	6	3.1
TAP 106(+025	E	10	2.0	8	2.5
TAP 156(+025	F	15	3.0	8	2.0
TAP 226(+025	H	22	4.4	8	1.5
TAP 336(+025	J	33	6.6	8	1.2
TAP 476(+025	M	47	9.4	8	1.0
TAP 686(+025	N	68	13.6	8	0.8
35 volt @ 85°C (23 volt @ 125°C)					
TAP 104(+035	A	0.1	0.5	4	26.0
TAP 154(+035	A	0.15	0.5	4	21.0
TAP 224(+035	A	0.22	0.5	4	17.0
TAP 334(+035	A	0.33	0.5	4	15.0
TAP 474(+035	A	0.47	0.5	4	13.0
TAP 684(+035	A	0.68	0.5	4	10.0
TAP 105(+035	A	1.0	0.5	4	8.0
TAP 155(+035	A	1.5	0.5	4	6.0
TAP 225(+035	B	2.2	0.6	6	5.0
TAP 335(+035	C	3.3	0.9	6	4.0
TAP 475(+035	E	4.7	1.3	6	3.0
TAP 685(+035	F	6.8	1.9	6	2.5
TAP 106(+035	F	10	2.8	8	2.0
TAP 156(+035	H	15	4.2	8	1.6
TAP 226(+035	K	22	6.1	8	1.3
TAP 336(+035	M	33	9.2	8	1.0
TAP 476(+035	N	47	10.0	8	0.8
50 volt @ 85°C (33 volt @ 125°C)					
TAP 104(+050	A	0.1	0.5	4	26.0
TAP 154(+050	A	0.15	0.5	4	21.0
TAP 224(+050	A	0.22	0.5	4	17.0
TAP 334(+050	A	0.33	0.5	4	15.0
TAP 474(+050	A	0.47	0.5	4	13.0
TAP 684(+050	B	0.68	0.5	4	10.0
TAP 105(+050	C	1.0	0.5	4	8.0
TAP 155(+050	D	1.5	0.6	4	6.0
TAP 225(+050	E	2.2	0.8	6	3.5
TAP 335(+050	F	3.3	1.3	6	3.0
TAP 475(+050	G	4.7	1.8	6	2.5
TAP 685(+050	H	6.8	2.7	6	2.0
TAP 106(+050	J	10	4.0	8	1.6
TAP 156(+050	K	15	6.0	8	1.2
TAP 226(+050	L	22	8.8	8	1.0

(*) Insert capacitance tolerance code; M for $\pm 20\%$, K for $\pm 10\%$ and J for $\pm 5\%$

NOTE: Voltage ratings are minimum values. AVX reserves the right to supply high-voltage ratings in the same case size.

SOLID TANTALUM RESIN DIPPED TAP

TAPE AND REEL PACKAGING FOR AUTOMATIC COMPONENT INSERTION

TAP types are all offered on radial tape, in reel or 'ammo' pack format for use on high speed radial automatic insertion equipment, or preforming machines.

The tape format is compatible with EIA 468A standard for component taping set out by major manufacturers of radial automatic insertion equipment.

TAP – available in three formats. See page 135 for dimensions.

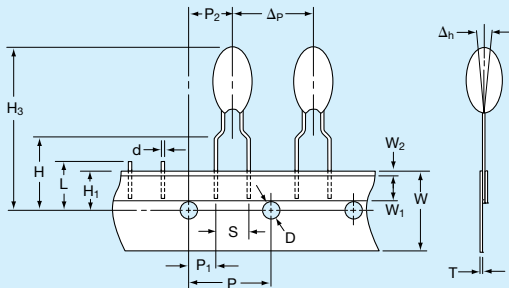

'B' wires for normal automatic insertion on 5mm pitch.

BRW suffix for reel
BRS suffix for 'ammo' pack
Available in case sizes A - J

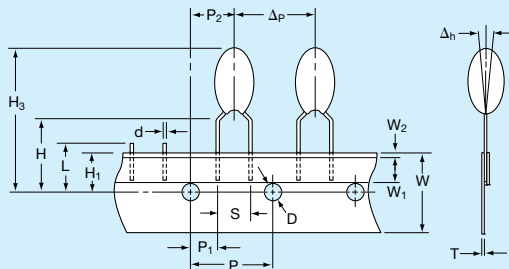

'C' wires for preforming.

CRW suffix for reel
CRS suffix for 'ammo' pack
Available in case sizes A - R

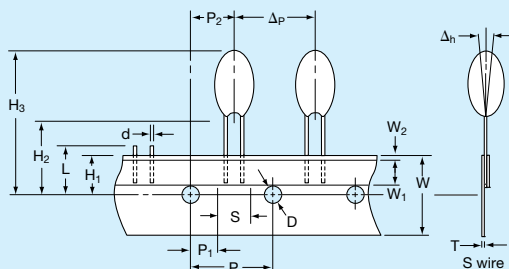

'S' and 'D' wire for special applications, automatic insertion on 2.5mm pitch.

SRW, DTW suffix for reel
SRS, DTS suffix for 'ammo' pack
Available in case sizes A - J

Dipped Radial Capacitors



Tape and Reel Packaging

SOLID TANTALUM RESIN DIPPED TAP

DIMENSIONS:

Description	Code	Dimension millimeters (inches)
Feed hole pitch	P	12.7 ± 0.30 (0.500 ± 0.010)
Hole center to lead	P ₁	3.85 ± 0.70 (0.150 ± 0.030) to be measured at bottom of clench
		5.05 ± 1.00 (0.200 ± 0.040) for S wire
Hole center to component center	P ₂	6.35 ± 0.40 (0.250 ± 0.020)
Change in pitch	Δp	± 1.00 (± 0.040)
Lead diameter	d	0.50 ± 0.05 (0.020 ± 0.003)
Lead spacing	S	See wire form table
Component alignment	Δh	0 ± 2.00 (0 ± 0.080)
Feed hole diameter	D	4.00 ± 0.20 (0.150 ± 0.008)
Tape width	W	18.0 + 1.00 (0.700 + 0.040) - 0.50 - 0.020)
Hold down tape width	W ₁	6.00 (0.240) min.
Hold down tape position	W ₂	1.00 (0.040) max.
Lead wire clench height	H	16.0 ± 0.50 (0.630 ± 0.020)
		19.0 ± 1.00 (0.750 ± 0.040) on request
Hole position	H ₁	9.00 ± 0.50 (0.350 ± 0.020)
Base of component height	H ₂	18.0 (0.700) min. (S wire only)
Component height	H ₃	32.25 (1.300) max.
Length of snipped lead	L	11.0 (0.430) max.
Total tape thickness	T	0.70 ± 0.20 (0.030 ± 0.001)
		Carrying card 0.50 ± 0.10 (0.020 ± 0.005)

REEL CONFIGURATION AND DIMENSIONS:

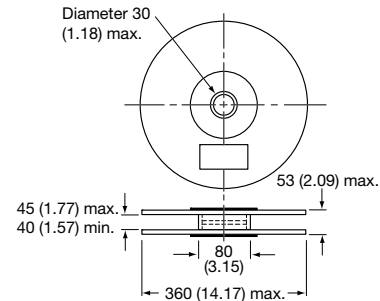

Manufactured from cardboard with plastic hub.

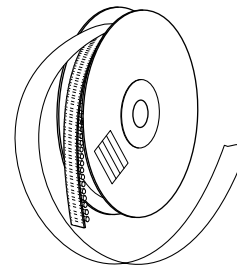

Holding tape outside. Positive terminal leading.

PACKAGING QUANTITIES

For Reels

Style	Case size	No. of pieces
TAP	A	1500
	B, C, D	1250
	E, F	1000
	G, H, J	750
	K, L, M, N, P, R	500

For 'Ammo' pack

Style	Case size	No. of pieces
TAP	A, B, C, D	3000
	E, F, G	2500
	H, J	2000
	K, L, M, N, P, R	1000

For bulk products

Style	Case size	No. of pieces
TAP	A to H	1000
	J to L	500
	M to R	100

AMMO PACK DIMENSIONS

millimeters (inches) max.

Height 360 (14.17), width 360 (14.17), thickness 60 (2.36)

GENERAL NOTES

Resin dipped tantalum capacitors are only available taped in the range of case sizes and in the modular quantities by case size as indicated.

Packaging quantities on tape may vary by ±1%.

Material Data and Handling

This should be read in conjunction with the Product Datasheet. Failure to observe the ratings and the information on this sheet may result in a safety hazard.

1. Material Content

Solid Tantalum and OxiCap® capacitors do not contain liquid hazardous materials.

The operating section contains:

Tantalum/Niobium	Graphite/carbon
Tantalum/Niobium oxide	Conducting paint/resins
Manganese dioxide	Fluoropolymers (not TAC)

The encapsulation contains:

TAA - solder, metal case, solder coated terminal wires, glass seal and plastic sleeve

TAC - epoxy molding compound, solder/tin coated terminal pads

TAJ, TPS, THJ, NOJ, NOS, NOM - epoxy molding compound, tin/solder coated terminal pads

TAP - solder, solder coated terminal wires, epoxy dipped resin

The epoxy resins may contain Antimony trioxide and Bromine compounds as fire retardants. The capacitors do not contain PBB or PBBO/PBBE. The solder alloys may contain lead.

2. Physical Form

These capacitors are physically small and are either rectangular with solderable terminal pads, or cylindrical or bead shaped with solderable terminal wires.

3. Intrinsic Properties

Operating

Both Tantalum and OxiCap® capacitors are polarized devices and operate satisfactorily in the correct d.c. mode. They will withstand a limited application of reverse voltage as stated in the datasheets. However, a reverse application of the rated voltage will result in early short circuit failure and may result in fire or explosion. Consequential failure of other associated components in the circuit e.g. diodes, transformers, etc. may also occur. When operated in the correct polarity, a long period of satisfactory operation will be obtained but failure may occur for any of the following reasons:

- normal failure rate
- surge voltage exceeded
- reverse voltage exceeded
- temperature too high
- ripple rating exceeded

If this failure mode is a short circuit, the previous conditions apply. If the adjacent circuit impedance is low, voltage or current surges may exceed the power handling capability of the capacitor. For this reason capacitors in circuits of below 1Ω/V should be derated by minimum 50% for tantalum and 20% for OxiCap®. Precautions should be taken to prevent reverse voltage spikes. Where capacitors may be subjected to fast switched, low impedance source voltages, the manufacturers advice should be sought to determine the most suitable capacitors for such applications.

Non-operating

Both Tantalum and OxiCap® capacitors contain no liquids or noxious gases to leak out. However, cracking or damage to the encapsulation may lead to premature failure due to ingress of material such as cleaning fluids or to stresses transmitted to the tantalum anode.

4. Fire Characteristics

Primary

Any component subject to abnormal power dissipation may

- self ignite
- become red hot
- break open or explode emitting flaming or red hot material, solid, molten or gaseous.

Fumes from burning components will vary in composition depending on the temperature, and should be considered to be hazardous, although fumes from a single component in a well ventilated area are unlikely to cause problems.

Secondary

Induced ignition may occur from an adjacent burning or red hot component. Epoxy resins used in the manufacture of capacitors give off noxious fumes when burning as stated above. Wherever possible, capacitors comply with the following: BS EN 60065

UL 492.60A/280

LOI (ASTM D2863-70) as stated in the datasheets.

5. Storage

Tantalum and OxiCap® capacitors exhibit a very low random failure rate after long periods of storage and apart from this there are no known modes of failure under normal storage conditions. All capacitors will withstand any environmental conditions within their ratings for the periods given in the detail specifications. Storage for longer periods under high humidity conditions may affect the leakage current of resin protected capacitors. Solderability of solder coated surfaces may be affected by storage of excess of 2 years. Recommended storage conditions: Temperature: 15°C-35°C

Humidity: 45-75% RH

6. Disposal

Incineration of epoxy coated capacitors will cause emission of noxious fumes and metal cased capacitors may explode due to build up of internal gas pressure. Disposal by any other means normally involves no special hazards. Large quantities may have salvage value.

7. Unsafe Use

Most failures are of a passive nature and do not represent a safety hazard. A hazard may, however, arise if this failure causes a dangerous malfunction of the equipment in which the capacitor is employed. Circuits should be designed to fail safe under the normal modes of failure. The usual failure mode is an increase in leakage current or short circuit. Other possible modes are decrease of capacitance, increase in dissipation factor (and impedance) or an open-circuit. Operations outside the ratings quoted in the datasheets represents unsafe use.

8. Handling

Careless handling of the cut terminal leads could result in scratches and/or skin punctures. Hands should be washed after handling solder coated terminals before eating or smoking, to avoid ingestion of lead. Capacitors must be kept out of the reach of small children. Care must be taken to discharge capacitors before handling as capacitors may retain a residual charge even after equipment in which they are being used has been switched off. Sparks from the discharge could ignite a flammable vapor.

Environmental Information

AVX has always sought to minimize the environmental impact of its manufacturing operations and of its capacitors supplied to customers throughout the world. We have a policy of preventing and minimizing waste streams during manufacture, and recycling materials wherever possible. We actively avoid or minimize environmentally hazardous materials in our production processes.

1. Material Content

For customers wishing to assess the environmental impact of AVX's capacitors contained in waste electrical and electronic equipment, the following information is provided:

Surface mount tantalum capacitors contain:

- Tantalum/Niobium and Tantalum/Niobium oxide
- Manganese dioxide
- Carbon/graphite
- Silver
- Nickel-iron alloy or Copper alloy depending on design (consult factory for details)
- Tin/Tin-lead alloy plating
- Polymers including fluorinated polymers
- Epoxide resin encapsulant

The encapsulant is made fire retardant to UL 94 V-0 by the inclusion of inert mineral filler, antimony trioxide and an organic bromine compound.

2. AVX capacitors do not contain any Polybrominated Biphenyl (PBB) or PBBE/PBBO, Mercury (Hg), Cadmium (Cd) or Hexavalent Chromium (Cr₆₊).

The approximate content of some materials is given in the table below for TAJ, TPS, THJ, TRJ, TPM, TCJ, TLJ, NOJ, NOS, NOM and NPV series:

Tantalum TAJ, TPS, THJ, TRJ, TPM, TLJ				Polymer TCJ		Niobium Oxide NOJ, NOS, NOM		CoreCap® NPV	
Case Size	Typical Weight (mg)	Antimony Trioxide (%)	Organic Bromine Compound (%)	Case Size	Typical Weight (mg)	Case Size	Typical Weight (mg)	Case Size	Typical Weight (mg)
A	31	1.2	0.9	A	31	A	26		
B	72	1.0	0.7	B	72	B	56		
C	194	0.9	0.7	C	194	C	154		
D	373	0.8	0.6			D	279		
E	531	1.0	0.7			E	399		
F	148	0.6	0.4						
G	27	0.0	0.0						
H	51	0.0	0.0	H	51				
J	4	0.8	0.6	J	4				
K	17.3	0.9	0.7						
N	9	0.0	0.0						
P	15	1.1	0.8			P	12		
R	10	1.0	0.7	R	10	R	9		
S	19	1.3	1.0			S	17		
T	35	1.1	0.9	T	35	T	32		
V	681	1.1	0.8			V	510	V	498
W	97	1.1	0.8	W	97	W	82		
X	158	1.1	0.8			X	127		
Y	237	1.2	0.9			Y	182		

NOJ, NOS, NOM series does not contain lead, antimony trioxide or organic bromine compound.

TAC series does not contain lead, antimony trioxide or organic bromine compound.

The specific weight of other materials contained in the various case sizes is available on written request. The component packing tape is either recyclable Polycarbonate or PVC (depending on case size), and the sealing tape is a laminate of halogen-free polymers. The reels are recyclable polystyrene, and marked with the recycling symbol. The reels are over-packed in recyclable fiber board boxes. None of the packing contains heavy metals.

3. Lead

Parts supplied today are electroplated over the terminal contact area with 100% Tin (Sn). Older products may contain lead comprising much less than 0.2% of the component weight.

4. Fire Retardants

Currently the only known way of supplying a fire retardant encapsulant which meets all our performance requirements, is to incorporate antimony trioxide and an organic bromine compound. These materials are commonly used in many plastic items in the home and industry. We expect to be able to offer an alternative fire retardant encapsulant, free of these materials, by 2005. A combustible encapsulant free of these materials could be supplied today, but AVX believes that the health and safety benefits of using these materials to provide fire retardancy during the life of the product, far outweigh the possible risks to the environment and human health.

5. Nickel alloy

It is intended that all case sizes will be made with a high copper alloy termination. Some case sizes are supplied now with this termination, and other sizes may be available. Please contact AVX if you prefer this.

6. Recycling

Surface mount Tantalum and OxiCap® capacitors have a very long service life with no known wear-out mechanism, and a low failure rate. However, parts contained in equipment which is of no further use will have some residual value mainly because of the Tantalum metal or niobium oxide contained. This can be recovered and recycled by specialist companies. The silver and nickel or copper alloy will also have some value. Please contact AVX if you require assistance with the disposal of parts. Packaging can be recycled as described above.

7. Disposal

Surface mount Tantalum and OxiCap® capacitors do not contain any liquids and no part of the devices is normally soluble in water at neutral pH values. Incineration will cause the emission of noxious fumes and is not recommended except by specialists. Landfill may be considered for disposal, bearing in mind the small lead content.

Under certain extreme physical conditions it is possible to generate ignition of Tantalum, Niobium and Niobium oxide capacitors. These physical conditions relate to high-speed impact and although not considered to be a normal operating occurrence may occur as a method of material(s) recovery. Therefore appropriate safeguards procedures and methodologies need to be adopted to eliminate any risks of material ignition.

Environmental Information

For further information, please contact your local AVX sales office or representative.

8. RoHS Compliance

AVX can declare that we do not add any materials from the list below to series TAJ, TPS, THJ, TRJ, TPM, TAC, TLC, TMC, TPC, NOJ, NOS, NOM and NPV during production, so they are not contained in any significant level.

Substances	Taping Code	RoHS Compliance	
Heavy Metals	Cadmium and cadmium compounds	All	YES
	Lead and lead compounds	A,B,Y,P	YES
		R,S	YES, since production date 1/1/04
	K,H	NO	
Mercury and mercury compounds	All	YES	
Hexavalent chromium compounds	All	YES	
Chlorinated organic compounds	Polychlorinated biphenyls (PCB)	All	YES
	Polychlorinated naphthalenes (PCN)	All	YES
	Chlorinated paraffins (CP)	All	YES
	Mirex (Perchlordecone)	All	YES
Brominated organic compounds	Polybrominated biphenyls (PBB)	All	YES
	Polybrominated diphenylethers (PBDE)	All	YES
Organic tin compounds	All	YES	
Asbestos	All	YES	
Azo compounds	All	YES	
Formaldehyde	All	YES	
Polyvinyl chloride (PVC) and PVC blends	All	YES	
Terpentyne	All	YES	

Section 2: Niobium Oxide Capacitors*

OxiCap® NOJ, NOS, NOM Series

DEVELOPMENT ROADMAP

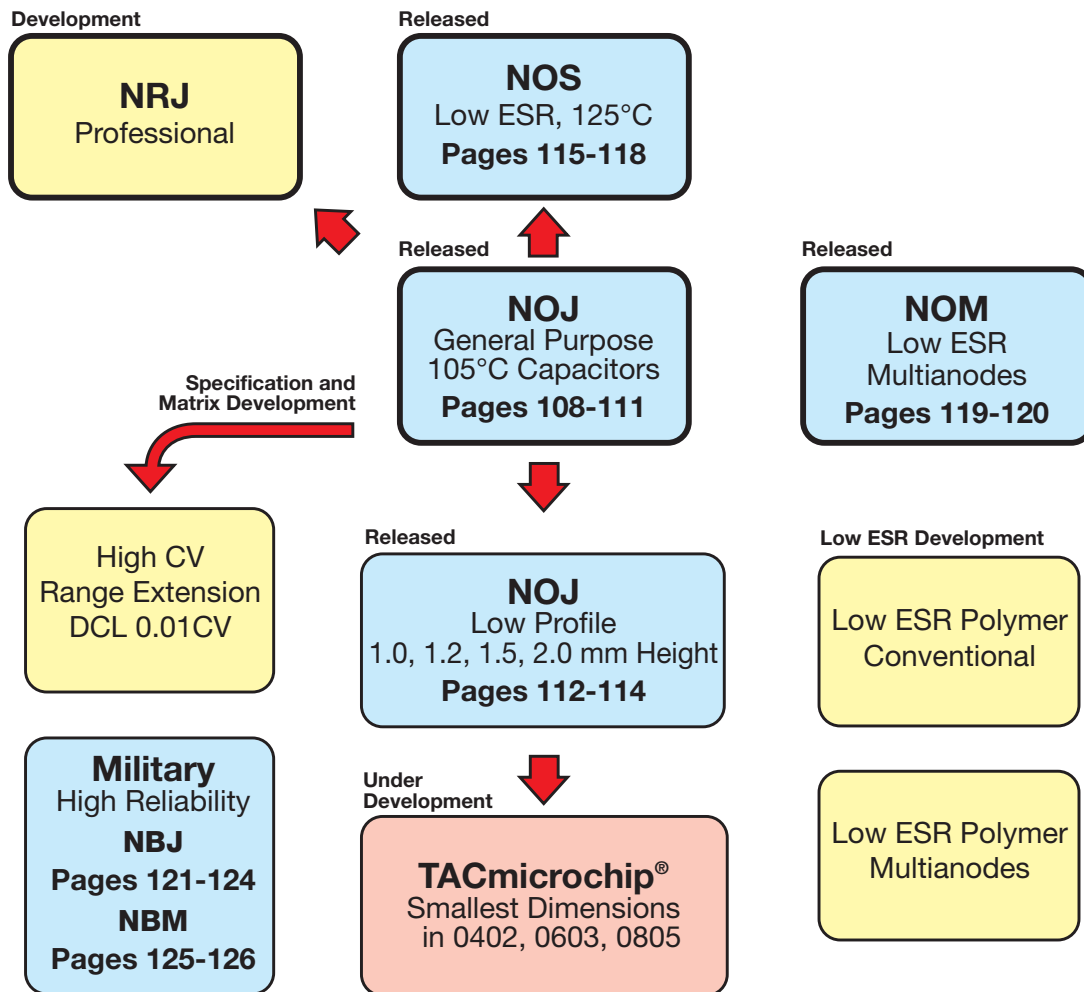

*Niobium Oxide Capacitors are manufactured and sold under patent license from Cabot Corporation, Boyertown, Pennsylvania U.S.A.

TAP Technical Summary and Application Guidelines



SECTION 1: ELECTRICAL CHARACTERISTICS AND EXPLANATION OF TERMS

1.1 CAPACITANCE

1.1.1 Rated capacitance (C_R)

This is the nominal rated capacitance. For tantalum capacitors it is measured as the capacitance of the equivalent series circuit at 20°C in a measuring bridge supplied by a 120 Hz source free of harmonics with 2.2V DC bias max.

1.1.2 Temperature dependence on the capacitance

The capacitance of a tantalum capacitor varies with temperature. This variation itself is dependent to a small extent on the rated voltage and capacitor size. See graph below for typical capacitance changes with temperature.

Typical Capacitance vs. Temperature

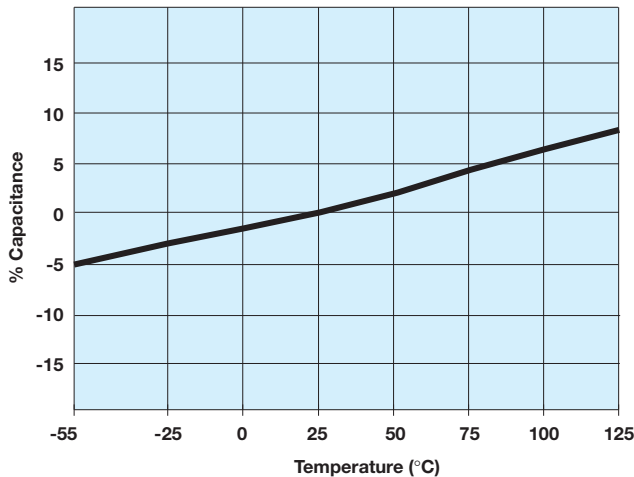

1.1.3 Capacitance tolerance

This is the permissible variation of the actual value of the capacitance from the rated value.

1.1.4 Frequency dependence of the capacitance

The effective capacitance decreases as frequency increases. Beyond 100 kHz the capacitance continues to drop until resonance is reached (typically between 0.5-5 MHz depending on the rating). Beyond this the device becomes inductive.

Typical Curve Capacitance vs. Frequency

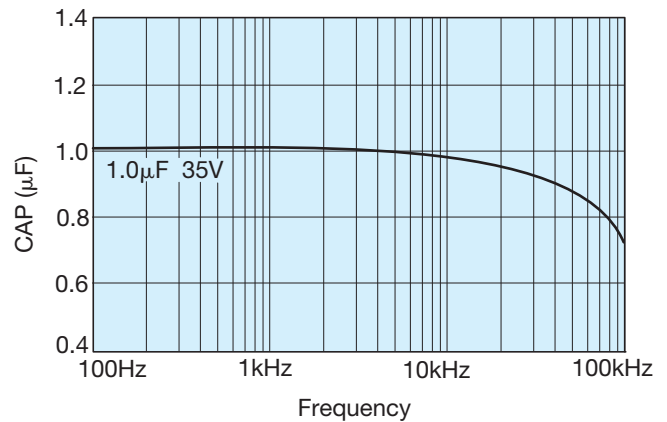

1.2 VOLTAGE

1.2.1 Rated DC voltage (V_R)

This is the rated DC voltage for continuous operation up to +85°C.

1.2.2 Category voltage (V_C)

This is the maximum voltage that may be applied continuously to a capacitor. It is equal to the rated voltage up to +85°C, beyond which it is subject to a linear derating, to 2/3 V_R at 125°C.

1.2.3 Surge voltage (V_S)

This is the highest voltage that may be applied to a capacitor for short periods of time. The surge voltage may be applied up to 10 times in an hour for periods of up to 30 seconds at a time. The surge voltage must not be used as a parameter in the design of circuits in which, in the normal course of operation, the capacitor is periodically charged and discharged.

Category Voltage vs. Temperature

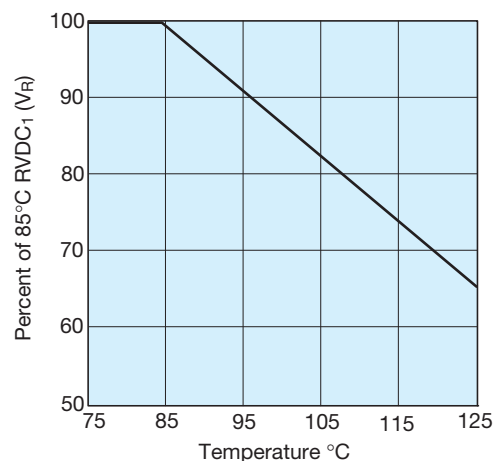

TAP Technical Summary and Application Guidelines



85°C		125°C	
Rated Voltage (V DC)	Surge Voltage (V DC)	Category Voltage (V DC)	Surge Voltage (V DC)
2	2.6	1.3	1.7
3	4	2	2.6
4	5.2	2.6	3.4
6.3	8	4	5
10	13	6.3	9
16	20	10	12
20	26	13	16
25	33	16	21
35	46	23	28
50	65	33	40

1.2.4 Effect of surges

The solid Tantalum capacitor has a limited ability to withstand surges (15% to 30% of rated voltage). This is in common with all other electrolytic capacitors and is due to the fact that they operate under very high electrical stress within the oxide layer. In the case of 'solid' electrolytic capacitors this is further complicated by the limited self healing ability of the manganese dioxide semiconductor.

It is important to ensure that the voltage across the terminals of the capacitor does not exceed the surge voltage rating at any time. This is particularly so in low impedance circuits where the capacitor is likely to be subjected to the full impact of surges, especially in low inductance applications. Even an extremely short duration spike is likely to cause damage. In such situations it will be necessary to use a higher voltage rating.

1.3 DISSIPATION FACTOR AND TANGENT OF LOSS ANGLE (TAN δ)

1.3.1 Dissipation factor (DF)

Dissipation factor is the measurement of the tangent of the loss angle (Tan δ) expressed as a percentage.

The measurement of DF is carried out at +25°C and 120 Hz with 2.2V DC bias max. with an AC voltage free of harmonics. The value of DF is temperature and frequency dependent.

1.3.2 Tangent of loss angle (Tan δ)

This is a measure of the energy loss in the capacitor. It is expressed as Tan δ and is the power loss of the capacitor divided by its reactive power at a sinusoidal voltage of specified frequency. (Terms also used are power factor, loss factor and dielectric loss, Cos (90 - δ) is the true power factor.) The measurement of Tan δ is carried out at +20°C and 120 Hz with 2.2V DC bias max. with an AC voltage free of harmonics.

1.2.5 Reverse voltage and non-polar operation

The reverse voltage ratings are designed to cover exceptional conditions of small level excursions into incorrect polarity. The values quoted are not intended to cover continuous reverse operation.

The peak reverse voltage applied to the capacitor must not exceed:

10% of rated DC working voltage to a maximum of 1V at 25°C

3% of rated DC working voltage to a maximum of 0.5V at 85°C

1% of category DC working voltage to a maximum of 0.1V at 125°C

1.2.6 Non-polar operation

If the higher reverse voltages are essential, then two capacitors, each of twice the required capacitance and of equal tolerance and rated voltage, should be connected in a back-to-back configuration, i.e., both anodes or both cathodes joined together. This is necessary in order to avoid a reduction in life expectancy.

1.2.7 Superimposed AC voltage (V_{rms}) - Ripple Voltage

This is the maximum RMS alternating voltage, superimposed on a DC voltage, that may be applied to a capacitor. The sum of the DC voltage and the surge value of the superimposed AC voltage must not exceed the category voltage, V_c. Full details are given in Section 2.

1.2.8 Voltage derating

Refer to section 3.2 (pages 172-173) for the effect of voltage derating on reliability.

1.3.3 Frequency dependence of dissipation factor

Dissipation Factor increases with frequency as shown in the typical curves below.

Typical Curve-Dissipation Factor vs. Frequency

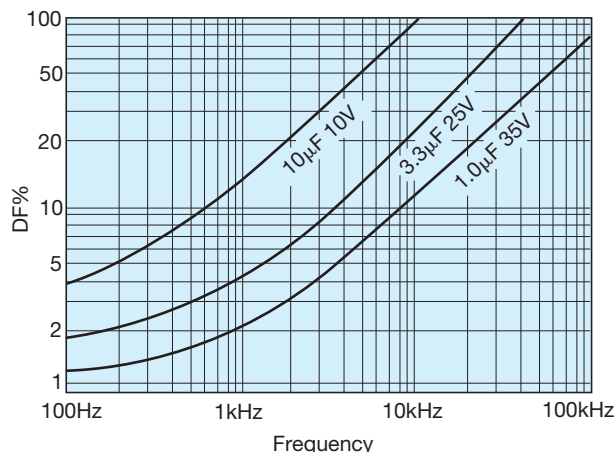

TAP Technical Summary and Application Guidelines



1.3.4 Temperature dependence of dissipation factor

Dissipation factor varies with temperature as the typical curves show to the right. For maximum limits please refer to ratings tables.

Typical Curves-Dissipation Factor vs. Temperature

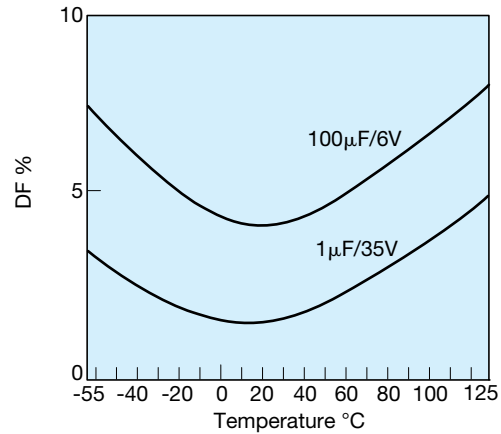

1.4 IMPEDANCE, (Z) AND EQUIVALENT SERIES RESISTANCE (ESR)

1.4.1 Impedance, Z

This is the ratio of voltage to current at a specified frequency. Three factors contribute to the impedance of a tantalum capacitor; the resistance of the semiconducting layer, the capacitance, and the inductance of the electrodes and leads.

At high frequencies the inductance of the leads becomes a limiting factor. The temperature and frequency behavior of these three factors of impedance determine the behavior of the impedance Z. The impedance is measured at 25°C and 100 kHz.

1.4.2 Equivalent series resistance, ESR

Resistance losses occur in all practical forms of capacitors. These are made up from several different mechanisms, including resistance in components and contacts, viscous forces within the dielectric, and defects producing bypass current paths. To express the effect of these losses they are considered as the ESR of the capacitor. The ESR is frequency dependent. The ESR can be found by using the relationship:

$$ESR = \frac{\tan \delta}{2\pi f C}$$

where f is the frequency in Hz, and C is the capacitance in farads. The ESR is measured at 25°C and 100 kHz.

ESR is one of the contributing factors to impedance, and at high frequencies (100 kHz and above) is the dominant factor, so that ESR and impedance become almost identical, impedance being marginally higher.

1.4.3 Frequency dependence of impedance and ESR

ESR and impedance both increase with decreasing frequency. At lower frequencies the values diverge as the extra contributions to impedance (resistance of the semiconducting layer, etc.) become more significant. Beyond 1 MHz (and beyond the resonant point of the capacitor) impedance again increases due to induction.

Frequency Dependence of Impedance and ESR

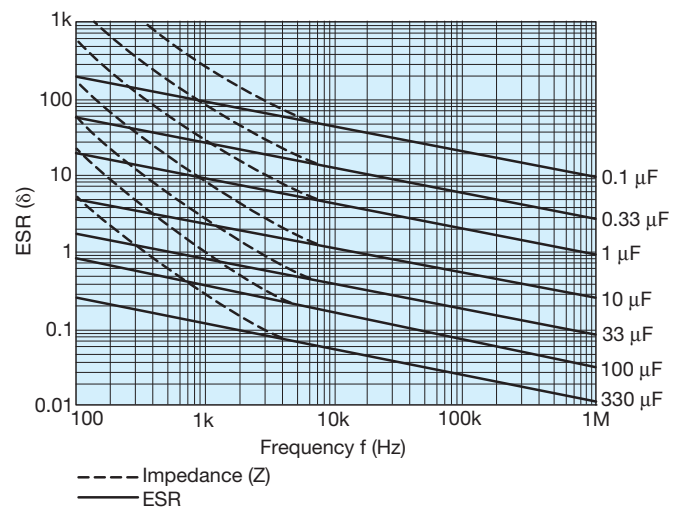

TAP Technical Summary and Application Guidelines



1.4.4 Temperature dependence of the impedance and ESR

At 100 kHz, impedance and ESR behave identically and decrease with increasing temperature as the typical curves show. For maximum limits at high and low temperatures, please refer to graph opposite.

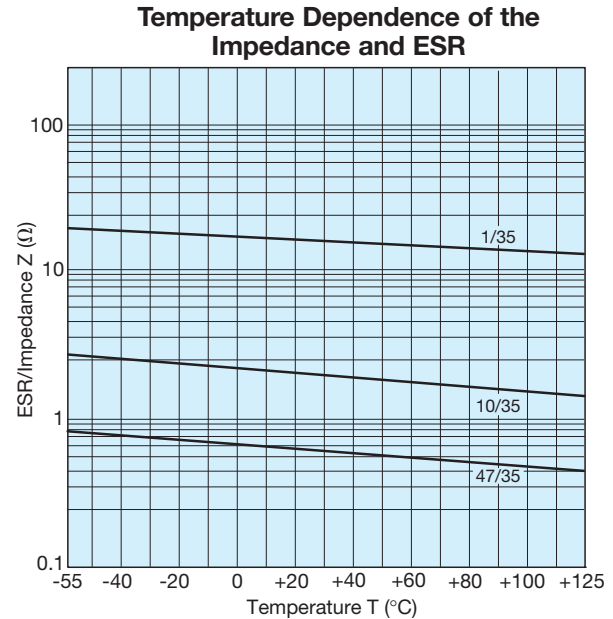

1.5 DC LEAKAGE CURRENT (DCL)

1.5.1 Leakage current (DCL)

The leakage current is dependent on the voltage applied, the time, and the capacitor temperature. It is measured at +25°C with the rated voltage applied. A protective resistance of 1000Ω is connected in series with the capacitor in the measuring circuit.

Three minutes after application of the rated voltage the leakage current must not exceed the maximum values indicated in the ratings table. Reforming is unnecessary even after prolonged periods without the application of voltage.

1.5.2 Temperature dependence of the leakage current

The leakage current increases with higher temperatures, typical values are shown in the graph.

For operation between 85°C and 125°C, the maximum working voltage must be derated and can be found from the following formula.

$$V_{\max} = \left(1 - \frac{T-85}{120}\right) \times V_R \text{ volts}$$

where T is the required operating temperature. Maximum limits are given in rating tables.

1.5.3 Voltage dependence of the leakage current

The leakage current drops rapidly below the value corresponding to the rated voltage V_R when reduced voltages are applied. The effect of voltage derating on the leakage current is shown in the graph.

This will also give a significant increase in reliability for any application. See Section 3 (pages 171-173) for details.

1.5.4 Ripple current

The maximum ripple current allowance can be calculated from the power dissipation limits for a given temperature rise above ambient. Please refer to Section 2 (page 170) for details.

Temperature Dependence of the Leakage Current for a Typical Component

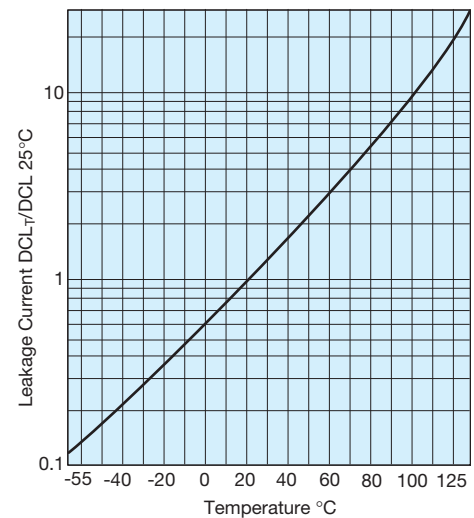

Effect of Voltage Derating on Leakage Current

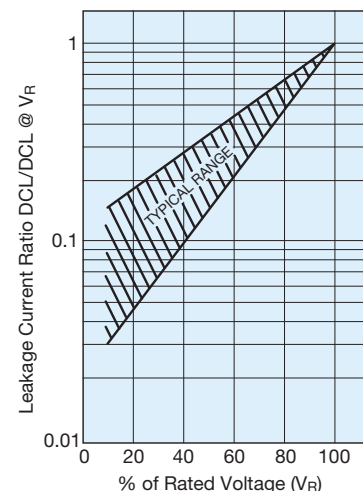

TAP Technical Summary and Application Guidelines



SECTION 2: AC OPERATION — RIPPLE VOLTAGE AND RIPPLE CURRENT

2.1 RIPPLE RATINGS (AC)

In an AC application heat is generated within the capacitor by both the AC component of the signal (which will depend upon signal form, amplitude and frequency), and by the DC leakage. For practical purposes the second factor is insignificant. The actual power dissipated in the capacitor is calculated using the formula:

$$P = I^2 R = \frac{E^2 R}{Z^2}$$

- I = rms ripple current, amperes
- R = equivalent series resistance, ohms
- E = rms ripple voltage, volts
- P = power dissipated, watts
- Z = impedance, ohms, at frequency under consideration

Using this formula it is possible to calculate the maximum AC ripple current and voltage permissible for a particular application.

2.2 MAXIMUM AC RIPPLE VOLTAGE (E_{max})

From the previous equation:

$$E_{(max)} = Z \sqrt{\frac{P_{max}}{R}}$$

where P_{max} is the maximum permissible ripple voltage as listed for the product under consideration (see table).

However, care must be taken to ensure that:

1. The DC working voltage of the capacitor must not be exceeded by the sum of the positive peak of the applied AC voltage and the DC bias voltage.
2. The sum of the applied DC bias voltage and the negative peak of the AC voltage must not allow a voltage reversal in excess of that defined in the sector, 'Reverse Voltage'.

2.3 MAXIMUM PERMISSIBLE POWER DISSIPATION (WATTS) @ 25°C

The maximum power dissipation at 25°C has been calculated for the various series and are shown in Section 2.4, together with temperature derating factors up to 125°C.

For leaded components the values are calculated for parts supported in air by their leads (free space dissipation).

The ripple ratings are set by defining the maximum temperature rise to be allowed under worst case conditions, i.e., with resistive losses at their maximum limit. This differential is normally 10°C at room temperature dropping to 2°C at 125°C. In application circuit layout, thermal management, available ventilation, and signal waveform may significantly

affect the values quoted below. It is recommended that temperature measurements are made on devices during operating conditions to ensure that the temperature differential between the device and the ambient temperature is less than 10°C up to 85°C and less than 2°C between 85°C and 125°C. Derating factors for temperatures above 25°C are also shown below. The maximum permissible proven dissipation should be multiplied by the appropriate derating factor.

For certain applications, e.g., power supply filtering, it may be desirable to obtain a screened level of ESR to enable higher ripple currents to be handled. Please contact our applications desk for information.

2.4 POWER DISSIPATION RATINGS (IN FREE AIR)

TAR – Molded Axial

Case size	Max. power dissipation (W)	Temperature derating factors	
		Temp. °C	Factor
Q	0.065	+25	1.0
R	0.075	+85	0.6
S	0.09	+125	0.4
W	0.105		

TAA – Hermetically Sealed Axial

Case size	Max. power dissipation (W)	Temperature derating factors	
		Temp. °C	Factor
A	0.09	+20	1.0
B	0.10	+85	0.9
C	0.125	+125	0.4
D	0.18		

TAP – Resin Dipped Radial

Case size	Max. power dissipation (W)	Temperature derating factors	
		Temp. °C	Factor
A	0.045	+25	1.0
B	0.05	+85	0.4
C	0.055	+125	0.09
D	0.06		
E	0.065		
F	0.075		
G	0.08		
H	0.085		
J	0.09		
K	0.1		
L	0.11		
M/N	0.12		
P	0.13		
R	0.14		



TAP Technical Summary and Application Guidelines



SECTION 3: RELIABILITY AND CALCULATION OF FAILURE RATE

3.1 STEADY-STATE

Tantalum Dielectric has essentially no wear out mechanism and in certain circumstances is capable of limited self healing, random failures can occur in operation. The failure rate of Tantalum capacitors will decrease with time and not increase as with other electrolytic capacitors and other electronic components.

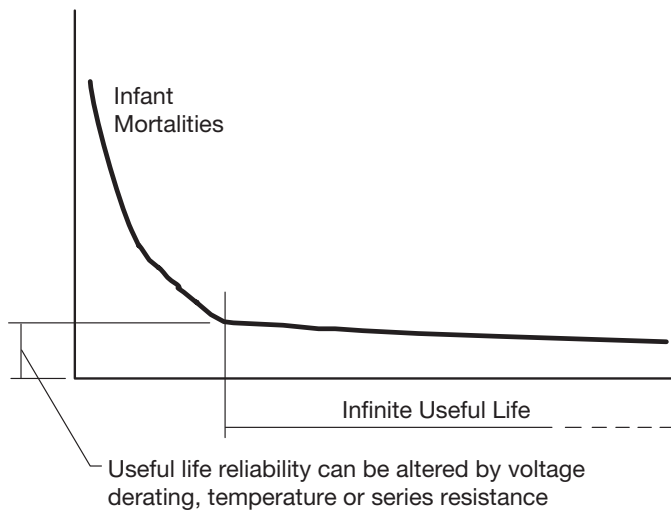

Figure 1. Tantalum reliability curve.

The useful life reliability of the Tantalum capacitor is affected by three factors. The equation from which the failure rate can be calculated is:

$$F = F_U \times F_T \times F_R \times F_B$$

where F_U is a correction factor due to operating voltage/voltage derating

F_T is a correction factor due to operating temperature

F_R is a correction factor due to circuit series resistance

F_B is the basic failure rate level. For standard leaded Tantalum product this is 1%/1000hours

Operating voltage/voltage derating

If a capacitor with a higher voltage rating than the maximum line voltage is used, then the operating reliability will be improved. This is known as voltage derating. The graph, Figure 2, shows the relationship between voltage derating (the ratio between applied and rated voltage) and the failure rate. The graph gives the correction factor F_U for any operating voltage.

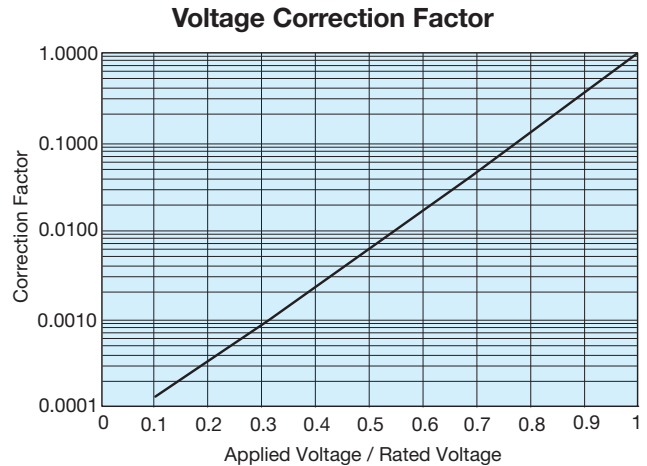

Figure 2. Correction factor to failure rate F for voltage derating of a typical component (60% con. level).

Operating temperature

If the operating temperature is below the rated temperature for the capacitor then the operating reliability will be improved as shown in Figure 3. This graph gives a correction factor F_T for any temperature of operation.

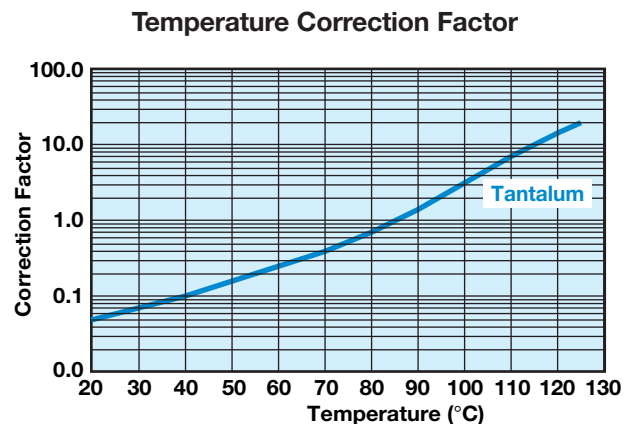

Figure 3. Correction factor to failure rate F for ambient temperature T for typical component (60% con. level).

TAP Technical Summary and Application Guidelines



Circuit Impedance

All solid tantalum capacitors require current limiting resistance to protect the dielectric from surges. A series resistor is recommended for this purpose. A lower circuit impedance may cause an increase in failure rate, especially at temperatures higher than 20°C. An inductive low impedance circuit may apply voltage surges to the capacitor and similarly a non-inductive circuit may apply current surges to the capacitor, causing localized over-heating and failure. The recommended impedance is 1Ω per volt. Where this is not feasible, equivalent voltage derating should be used (See MIL HANDBOOK 217E). Table I shows the correction factor, F_R , for increasing series resistance.

Table I: Circuit Impedance

Correction factor to failure rate F for series resistance R on basic failure rate F_B for a typical component (60% con. level).

Circuit Resistance ohms/volt	FR
3.0	0.07
2.0	0.1
1.0	0.2
0.8	0.3
0.6	0.4
0.4	0.6
0.2	0.8
0.1	1.0

Example calculation

Consider a 12 volt power line. The designer needs about 10μF of capacitance to act as a decoupling capacitor near a video bandwidth amplifier. Thus the circuit impedance will be limited only by the output impedance of the boards power unit and the track resistance. Let us assume it to be about 2 Ohms minimum, i.e., 0.167 Ohms/Volt. The operating temperature range is -25°C to +85°C. If a 10μF 16 Volt capacitor was designed-in, the operating failure rate would be as follows:

- a) $F_T = 0.8 @ 85°C$
- b) $F_R = 0.7 @ 0.167 \text{ Ohms/Volt}$
- c) $F_U = 0.17 @ \text{applied voltage/rated voltage} = 75\%$

Thus $F_B = 0.8 \times 0.7 \times 0.17 \times 1 = 0.0952\%/1000 \text{ Hours}$

If the capacitor was changed for a 20 volt capacitor, the operating failure rate will change as shown.

$F_U = 0.05 @ \text{applied voltage/rated voltage} = 60\%$
 $F_B = 0.8 \times 0.7 \times 0.05 \times 1 = 0.028\%/1000 \text{ Hours}$

3.2 DYNAMIC

As stated in Section 1.2.4 (page 167), the solid Tantalum capacitor has a limited ability to withstand voltage and current surges. Such current surges can cause a capacitor to fail. The expected failure rate cannot be calculated by a simple formula as in the case of steady-state reliability. The two parameters under the control of the circuit design engineer known to reduce the incidence of failures are derating and series resistance. The table below summarizes the results of trials carried out at AVX with a piece of equipment which has very low series resistance and applied no derating. So that the capacitor was tested at its rated voltage.

Results of production scale derating experiment

Capacitance and Voltage	Number of units tested	50% derating applied	No derating applied
47μF 16V	1,547,587	0.03%	1.1%
100μF 10V	632,876	0.01%	0.5%
22μF 25V	2,256,258	0.05%	0.3%

As can clearly be seen from the results of this experiment, the more derating applied by the user, the less likely the probability of a surge failure occurring.

It must be remembered that these results were derived from a highly accelerated surge test machine, and failure rates in the low ppm are more likely with the end customer.



TAP Technical Summary and Application Guidelines



A commonly held misconception is that the leakage current of a Tantalum capacitor can predict the number of failures which will be seen on a surge screen. This can be disproved by the results of an experiment carried out at AVX on 47µF 10V surface mount capacitors with different leakage currents. The results are summarized in the table below.

Leakage Current vs Number of Surge Failures

	Number tested	Number failed surge
Standard leakage range 0.1 µA to 1µA	10,000	25
Over Catalog limit 5µA to 50µA	10,000	26
Classified Short Circuit 50µA to 500µA	10,000	25

Again, it must be remembered that these results were derived from a highly accelerated surge test machine, and failure rates in the low ppm are more likely with the end customer.

AVX recommended derating table

Voltage Rail	Working Cap Voltage
3.3	6.3
5	10
10	20
12	25
15	35
≥24	Series Combinations (11)

For further details on surge in Tantalum capacitors refer to J.A. Gill's paper "Surge in Solid Tantalum Capacitors", available from AVX offices worldwide.

An added bonus of increasing the derating applied in a circuit, to improve the ability of the capacitor to withstand surge conditions, is that the steady-state reliability is improved by up to an order. Consider the example of a 6.3 volt capacitor being used on a 5 volt rail. The steady-state reliability of a Tantalum capacitor is affected by three parameters; temperature, series resistance and voltage derating. Assuming 40°C operation and 0.1Ω/volt of series resistance, the scaling factors for temperature and series resistance will both be 0.05 [see Section 3.1 (page 171)]. The derating factor will be 0.15. The capacitors reliability will therefore be

$$\begin{aligned} \text{Failure rate} &= F_U \times F_T \times F_R \times 1\%/1000 \text{ hours} \\ &= 0.15 \times 0.05 \times 1 \times 1\%/1000 \text{ hours} \\ &= 7.5\% \times 10^{-3}/\text{hours} \end{aligned}$$

If a 10 volt capacitor was used instead, the new scaling factor would be 0.017, thus the steady-state reliability would be

$$\begin{aligned} \text{Failure rate} &= F_U \times F_T \times F_R \times 1\%/1000 \text{ hours} \\ &= 0.017 \times 0.05 \times 1 \times 1\%/1000 \text{ hours} \\ &= 8.5\% \times 10^{-4}/1000 \text{ hours} \end{aligned}$$

So there is an order improvement in the capacitors steady-state reliability.

3.3 RELIABILITY TESTING

AVX performs extensive life testing on tantalum capacitors.

- 2,000 hour tests as part of our regular Quality Assurance Program.

Test conditions:

- 85°C/rated voltage/circuit impedance of 3Ω max.
- 125°C/0.67 x rated voltage/circuit impedance of 3Ω max.

3.4 Mode of Failure

This is normally an increase in leakage current which ultimately becomes a short circuit.

TAP Technical Summary and Application Guidelines



SECTION 4: APPLICATION GUIDELINES FOR TANTALUM CAPACITORS

4.1 SOLDERING CONDITIONS AND BOARD ATTACHMENT

The soldering temperature and time should be the minimum for a good connection.

A suitable combination for wavesoldering is 230°C - 250°C for 3 - 5 seconds.

Small parametric shifts may be noted immediately after wave solder, components should be allowed to stabilize at room temperature prior to electrical testing.

AVX leaded tantalum capacitors are designed for wave soldering operations.

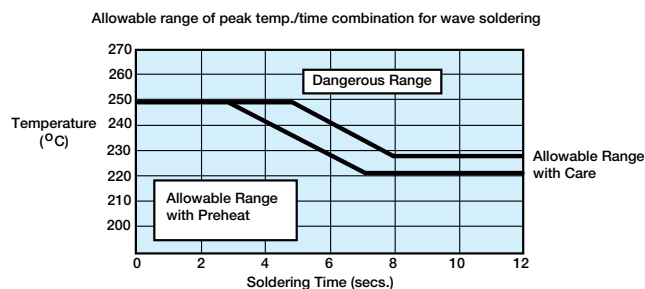

4.2 RECOMMENDED SOLDERING PROFILES

Recommended wave soldering profile for mounting of tantalum capacitors is shown below.

After soldering the assembly should preferably be allowed to cool naturally. In the event that assisted cooling is used, the rate of change in temperature should not exceed that used in reflow.

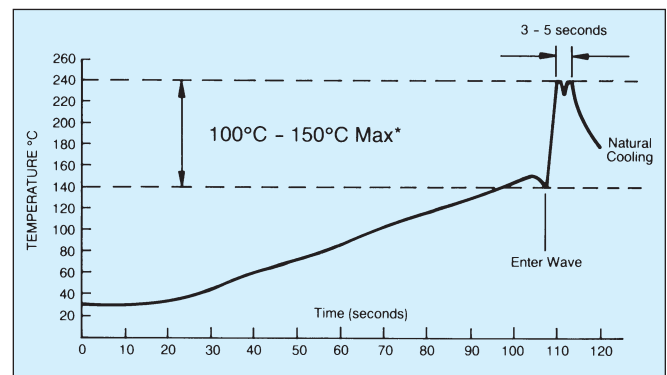

*See appropriate product specification

SECTION 5: MECHANICAL AND THERMAL PROPERTIES, LEADED CAPACITORS

5.1 ACCELERATION

10 g (981 m/s)

5.2 VIBRATION SEVERITY

10 to 2000 Hz, 0.75 mm or 98 m/s²

5.3 SHOCK

Trapezoidal Pulse 10 g (981 m/s) for 6 ms

5.4 TENSILE STRENGTH OF CONNECTION

10 N for type TAR, 5 N for type TAP.

5.5 BENDING STRENGTH OF CONNECTIONS

2 bends at 90°C with 50% of the tensile strength test loading.

5.6 SOLDERING CONDITIONS

Dip soldering permissible provided solder bath temperature $\leq 270^\circ\text{C}$; solder time < 3 sec.; circuit board thickness ≥ 1.0 mm.

5.7 INSTALLATION INSTRUCTIONS

The upper temperature limit (maximum capacitor surface temperature) must not be exceeded even under the most unfavorable conditions when the capacitor is installed. This must be considered particularly when it is positioned near components which radiate heat strongly (e.g., valves and power transistors). Furthermore, care must be taken, when bending the wires, that the bending forces do not strain the capacitor housing.

5.8 INSTALLATION POSITION

No restriction.

5.9 SOLDERING INSTRUCTIONS

Fluxes containing acids must not be used.

Technical Summary and Application Guidelines

QUESTIONS AND ANSWERS

Some commonly asked questions regarding Tantalum Capacitors:

Question: If I use several tantalum capacitors in serial/parallel combinations, how can I ensure equal current and voltage sharing?

Answer: Connecting two or more capacitors in series and parallel combinations allows almost any value and rating to be constructed for use in an application. For example, a capacitance of more than 60µF is required in a circuit for stable operation. The working voltage rail is 24 Volts dc with a superimposed ripple of 1.5 Volts at 120 Hz.

The maximum voltage seen by the capacitor is $V_{dc} + V_{ac}=25.5V$

Applying the 50% derate rule tells us that a 50V capacitor is required.

Connecting two 25V rated capacitors in series will give the required capacitance voltage rating, but the effective capacitance will be halved, so for greater than

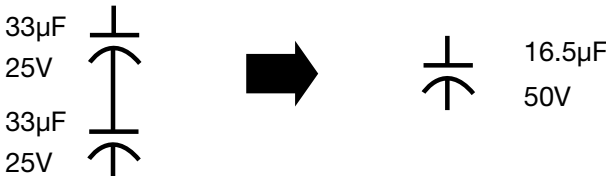

60µF, four such series combinations are required, as shown.

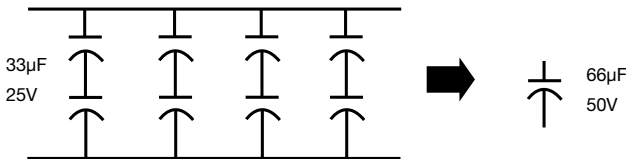

In order to ensure reliable operation, the capacitors should be connected as shown below to allow current sharing of the ac noise and ripple signals. This prevents any one capacitor heating more than its neighbors and thus being the weak link in the chain.

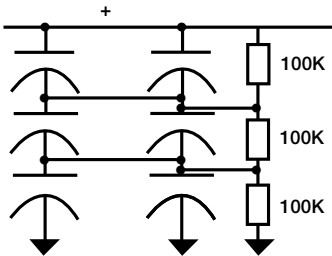

The two resistors are used to ensure that the leakage currents of the capacitors does not affect the circuit reliability, by ensuring that all the capacitors have half the working voltage across them.

Question: What are the advantages of tantalum over other capacitor technologies?

Answer:

1. Tantalums have high volumetric efficiency.
2. Electrical performance over temperature is very stable.
3. They have a wide operating temperature range -55 degrees C to +125 degrees C.
4. They have better frequency characteristics than aluminum electrolytics.
5. No wear out mechanism. Because of their construction, solid tantalum capacitors do not degrade in performance or reliability over time.

Question: If the part is rated as a 25 volt part and you have current surged it, why can't I use it at 25 volts in a low impedance circuit?

Answer: The high volumetric efficiency obtained using tantalum technology is accomplished by using an extremely thin film of tantalum pentoxide as the dielectric. Even an application of the relatively low voltage of 25 volts will produce a large field strength as seen by the dielectric. As a result of this, derating has a significant impact on reliability as described under the reliability section. The following example uses a 22 microfarad capacitor rated at 25 volts to illustrate the point. The equation for determining the amount of surface area for a capacitor is as follows:

$$C = (\epsilon_r \epsilon_0 (A)) / d$$

$$A = (C (d)) / (\epsilon_r \epsilon_0)$$

$$A = ((22 \times 10^{-6}) (170 \times 10^{-9})) / ((8.85 \times 10^{-12}) (27))$$

$$A = 0.015 \text{ square meters (150 square centimeters)}$$

Where C = Capacitance in farads

A = Dielectric (Electrode) Surface Area (m²)

d = Dielectric thickness (Space between dielectric) (m)

ϵ_r = Dielectric constant (27 for tantalum)

ϵ_0 = Dielectric Constant relative to a vacuum
(8.855×10^{-12} Farads x m⁻¹)

To compute the field voltage potential felt by the dielectric we use the following logic.

$$\text{Dielectric formation potential} = \text{Formation Ratio} \times \text{Working Voltage}$$

$$= 4 \times 25$$

$$\text{Formation Potential} = 100 \text{ volts}$$

Dielectric (Ta₂O₅) Thickness (d) is 1.7×10^{-9} Meters Per Volt
 $d = 0.17 \mu \text{ meters}$

$$\text{Electric Field Strength} = \text{Working Voltage} / d$$

$$= (25 / 0.17 \mu \text{ meters})$$

$$= 147 \text{ Kilovolts per millimeter}$$

$$= 147 \text{ Megavolts per meter}$$

Technical Summary and Application Guidelines

QUESTIONS AND ANSWERS

No matter how pure the raw tantalum powder or the precision of processing, there will always be impurity sites in the dielectric. We attempt to stress these sites in the factory with overvoltage surges, and elevated temperature burn in so that components will fail in the factory and not in your product. Unfortunately, within this large area of tantalum pentoxide, impurity sites will exist in all capacitors. To minimize the possibility of providing enough activation energy for these impurity sites to turn from an amorphous state to a crystalline state that will conduct energy, series resistance and derating is recommended. By reducing the electric field within the anode at these sites, the tantalum capacitor has increased reliability. Tantalums differ from other electrolytics in that charge transients are carried by electronic conduction rather than absorption of ions.

Question: What negative transients can Solid Tantalum Capacitors operate under?

Answer: The reverse voltage ratings are designed to cover exceptional conditions of small level excursions into incorrect polarity. The values quoted are not intended to cover continuous reverse operation. The peak reverse voltage applied to the capacitor must not exceed:

- 10% of rated DC working voltage to a maximum of 1 volt at 25°C.
- 3% of rated DC working voltage to a maximum of 0.5 volt at 85°C.
- 1% of category DC working voltage to a maximum of 0.1 volt at 125°C.

Question: I have read that manufacturers recommend a series resistance of 0.1 ohm per working volt. You suggest we use 1 ohm per volt in a low impedance circuit. Why?

Answer: We are talking about two very different sets of circuit conditions for those recommendations. The 0.1 ohm per volt recommendation is for steady-state conditions. This level of resistance is used as a basis for the series resistance variable in a 1% / 1000 hours 60% confidence level reference. This is what steady-state life tests are based on. The 1 ohm per volt is recommended for dynamic conditions which include current in-rush applications such as inputs to power supply circuits. In many power supply topologies where the di/dt through the capacitor(s) is limited, (such as most implementations of buck (current mode), forward converter, and flyback), the requirement for series resistance is decreased.

Question: How long is the shelf life for a tantalum capacitor?

Answer: Solid tantalum capacitors have no limitation on shelf life. The dielectric is stable and no reformation is required. The only factors that affect future performance of the capacitors would be high humidity conditions and extreme storage temperatures. Solderability of solder coated surfaces may be affected by storage in excess of 2 years. Recommended storage conditions are: Temperature between 15°C and 35°C with humidity 45%-75% RH. Terminations should be checked for solderability in the event an oxidation develops on the solder plating.

Question: Are there any recommendations/limitation for capacitor selection in parallel combination of capacitors?

Answer: Higher performance series TPS, TPM, NOS, NOM, TCJ are designed to provide lower ESR values and make the product more robust against current surges. The design differences make the better performance distribution of parameters, namely ESR is lower and tighter compared to the general purpose TAJ series. The surge current load in a parallel combination of capacitors is therefore shared more evenly amongst the capacitors and thus it is better suited for this application.

In a parallel combination is is strongly recommended to use the low ESR series of Tantalum Capacitors such as TPS, TPM, NOS, NOM and TCJ. Do not combine different series of manufacturers within one parallel combination.

Question: What level of voltage derating is needed for Tantalum Capacitors?

Answer: For many years whenever people have asked a tantalum capacitor manufacturer about what were the safe guidelines for using their product, they spoke with one voice "a minimum of 50% voltage derating should be applied". This message has since become ingrained and automatic. This article challenges this statement and explains why it is not necessarily the case.

The 50% rule came about when tantalum capacitors started to be used on low impedance sources. In such applications, the available current is high and therefore a risk of failure is inherent. Well established by empirical methods and covered in MIL-STD 317, was the fact that the amount of voltage derating has a major influence on the failure rate of a tantalum capacitor (Figure 1). Indeed, from rated voltage to 50% of rated voltage is an improvement in failure rate of more than 100.

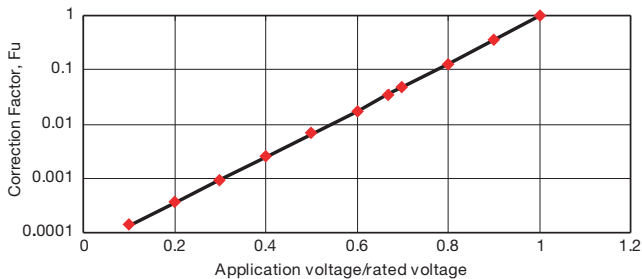
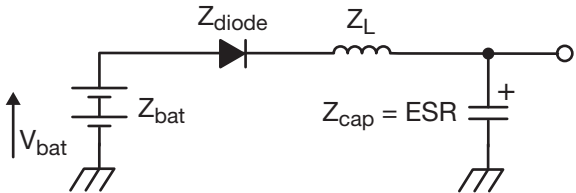

Figure 1

It was also proved that the same was true of dynamic, high current pulse conditions', hence the recommendation.

Now let us look more closely at the type of circuits in use. Below is a simple circuit which will be discussed further in this text.



Technical Summary and Application Guidelines

Let us assume this is a 2 cell battery system, therefore

$$V_{\text{bat}} = 3.2 \text{ Volts}$$

Also, let us assume

$$Z_{\text{bat}} = 60 \text{ m}\Omega, Z_{\text{diode}} = 70 \text{ m}\Omega, Z_{\text{cap}} = 120 \text{ m}\Omega, Z_L = 70 \text{ m}\Omega$$

If the “50% rule” was followed, the designer should chose a 6.3V rated capacitor.

The total circuit impedance of the system is 320 mΩ. So by Ohm’s law the peak current would be 10 Amps.

This exceeds the test conditions used by AVX to screen its product for high current pulses¹, so a risk of failure exists. Clearly a minimum of a 10 volt rate capacitor is required in this application.

As a general rule of thumb, the maximum current a tantalum capacitor can withstand (provided it has not been damaged by thermomechanical damage^{2 3} or some other external influence) is given by the equation:

$$I_{\text{max}} = V_{\text{rated}} / (1 + \text{Catalog ESR})$$

So for example for a 100μF 10V D case capacitor (Catalog ESR = 0.9 Ohms), this would be:

$$I_{\text{max}} = 10 / (1 + 0.9) = 5.2 \text{ Amps}$$

In some circuits, because of size restrictions, a tantalum capacitor may be the only option available. If this is the case, AVX recommends a PFET integrator be used to slow the voltage ramp at turn on, which in effect reduces the peak current, and therefore reduces the risk of failure⁴.

Now, let’s consider a continuation of the circuit with the addition of an LDO or DC/DC convertor.

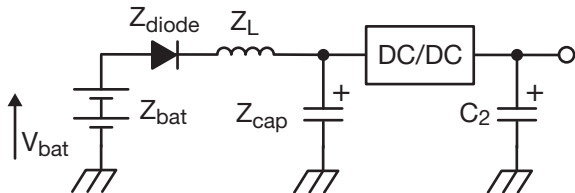

The risk of a high surge current being seen by the capacitor in location C₂ is very small. Therefore if we assume the voltage rail is 2.8 volts and the maximum current seen by C₂ is <1.5 Amps, a 4 volt capacitor could be able to be used in this application.

This all seems like good news, but as always, there are some downsides to using a part nearer to its rated voltage. The first is the steady-state life, or MTBF. The MTBF of a tantalum capacitor is easily calculated from MIL-STD 317 or the supplier’s catalog data. An example is given below:

Assume operating temperature is 85°C and circuit impedance 0.1 Ohms/volt (F_T = 1).

For a 10 volt rated capacitor on a 5 volt rated line, the failure rate is:

$$\begin{aligned} F_R &= 1\%/1000 \text{ hours} \times F_T \times F_U \times F_R \\ &= 1\%/1000 \text{ hours} \times 1 \times 0.007 \text{ (from Figure 1)} \times 1 \\ &= 0.007\%/1000 \text{ hours} \end{aligned}$$

$$\begin{aligned} \text{MTBF} &= 10^5 / F_R \\ &= 14,285,238 \text{ hours} \\ &= 1,631 \text{ years} \end{aligned}$$

For a 6.3 volt rated capacitor on a 5 volt rated line, the failure rate is:

$$\begin{aligned} F_R &= 1\%/1000 \text{ hours} \times F_T \times F_U \times F_R \\ &= 1\%/1000 \text{ hours} \times 1 \times 0.12 \text{ (from Figure 1)} \times 1 \\ &= 0.12\%/1000 \text{ hours} \end{aligned}$$

$$\begin{aligned} \text{MTBF} &= 10^5 / F_R \\ &= 833,333 \text{ hours} \\ &= 95 \text{ years} \end{aligned}$$

The second factor to be considered is that the more derating applied to a tantalum capacitor, the lower the leakage current level (Figure 2). Therefore a part used at 50% of its rated voltage will have more than 3 times better leakage levels than one used at 80%.

Leakage Current vs. Rated Voltage

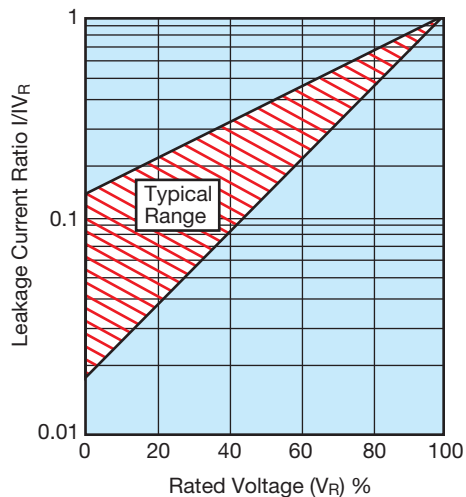

Figure 2

One final point worthy of mention with the introduction of higher reflow temperatures with the introduction of lead-free solders is that voltage derating can help to reduce the risk of failures due to thermomechanical damage during reflow.

To summarize, a tantalum capacitor is capable of being used at its rated voltage or close to it, provided that the user obeys the rules outlined in this document and is prepared for the reduced steady-state life performance and higher leakage current levels this would produce.

¹ Surge in Solid Tantalum Capacitors, John Gill, AVX Tantalum

² IR Reflow Guidelines for Tantalum Capacitors, Steve Warden & John Gill, AVX Tantalum

³ Mounting Guidelines in AVX Tantalum Catalog

⁴ Improving Reliability of Tantalum Capacitors in Low Impedance Circuits, Dave Mattingly, AVX

Section 1: Introduction



AVX Tantalum

APPLICATIONS

		
2-16 Volt Low ESR Low Profile Case 0603 available Low Failure Rate High Volumetric Efficiency Temperature Stability Stable over Time	50 Volt @ 85°C 33 Volt @ 125°C Automotive Range High Reliability Temperature Stability QS9000 Approved TS 16949 Plant Approved Up to 150°C AEC Q200 Approval	2 - 16 Volts Low ESR World's Smallest Tantalum 0402 Available High Volumetric Efficiency Low Profile Versions

QUALITY STATEMENTS

AVX's focus is CUSTOMER satisfaction - customer satisfaction in the broadest sense: product quality, technical support, product availability - all at a competitive price.

In pursuance of the established goals of our corporate wide QV2000 program, it is the stated objective of AVX Tantalum to supply our customers with a world class service in the manufacture and supply of electronic components, while maintaining a positive return on investment.

This world class service shall be defined as consistently supplying product and services of the highest quality and reliability encompassing all aspects of the customer supply chain.

In addition, any new or changed products, processes or services will be qualified to established standards of quality and reliability.

The objectives and guidelines listed above shall be achieved by the following codes of practice:

1. Continual objective evaluation of customer needs and expectations for the future and the leverage of all AVX resources to meet this challenge.

2. Continually fostering and promoting a culture of continuous improvement through ongoing training and empowered participation of employees at all levels of the company.

3. Continuous Process Improvement using sound engineering principles to enhance existing equipment, material and processes. This includes the application of the science of S.P.C. focused on improving the Process Capability Index, Cpk.

The Tantalum division has plants approved to ISO9001:2000 and TS16949:2002 (Automotive Quality System Requirements) with the intention that all facilities world-wide will adopt this as the quality standard.

Dedicated series of tantalum and niobium oxide capacitors meets requirements of AEC-Q200.

The Tantalum division has plants approved to ISO14001 with the intention that all facilities world-wide will adopt this as the quality standard.



Introduction



AVX Tantalum

AVX Paignton UK is the Divisional Headquarters for the Tantalum division which has manufacturing locations in Paignton in the UK, Biddeford in Maine, USA, Juarez in Mexico, Lanskrout in the Czech Republic, San Salvador, in El Salvador and Tianjin in P.R. China.

This division manufactures tantalum and niobium oxide capacitors. Tantalum is an element extracted from ores found alongside tin and niobium deposits; the major sources of supply are Canada, Brazil and Australasia.

TECHNOLOGY TRENDS

The amount of capacitance possible in a tantalum capacitor is directly related to the type of tantalum powder used to manufacture the anode.

The graph following shows how the (capacitance) x (voltage) per gram (CV/g) has steadily increased over time, thus allowing the production of larger and larger capacitances with the same physical volume. CV/g is the measure used to define the volumetric efficiency of a powder, a high CV/g means a higher capacitance from the same volume.

These powder improvements have been achieved through close development with the material suppliers. AVX Tantalum is committed to driving the available technology forward as is clearly demonstrated by extended ratings continually being developed, and new technologies such as TACmicrochip® and OxiCap® technology.

If you have any specific requirements, please contact your local AVX sales office for details on how AVX Tantalum can assist you in addressing your future requirements.

WORKING WITH THE CUSTOMER - ONE STOP SHOPPING

In line with our desire to become the number one supplier in the world for passive and interconnection components, AVX is constantly looking forward and innovating.

It is not good enough to market the best products; the customer must have access to a service system which suits their needs and benefits their business.

The AVX 'one stop shopping' concept is already beneficial in meeting the needs of major OEMs while worldwide partnerships with only the premier division of distributors aids the smaller user.

Helping to market and support our customers across the breadth and depth of our electronic component line card are a dedicated team of sales engineers, applications engineers

Niobium oxide is a ceramic material that can be processed to the same powder form as traditional tantalum capacitors and manufactured in an identical process.

So for high volume tantalum and niobium oxide capacitors with leading edge technology call us first - **AVX your global partner.**

Niobium oxide capacitors have been assigned the OxiCap® trademark.

Tantalum Powder CV/gm

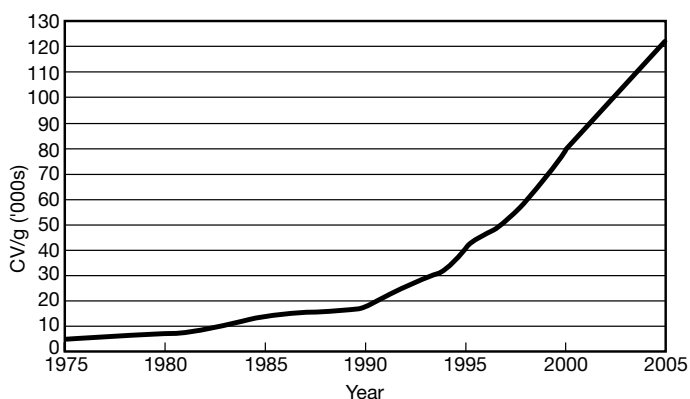

and product marketing managers. Their qualifications are hopefully always appropriate to your commercial needs, but as higher levels of technical expertise are required, access directly to the appropriate department is seamless and transparent.

Total quality starts and finishes with our commitment to customer service. Where cost and quality are perceived as given quantities AVX's first in class service invariably places us in the top rank of any preferred supplier list.

Facilities are equipped with instant worldwide DP and telecommunication links connected to every sales and production site worldwide. That ensures our customers' delivery requirements are consistently met wherever in the world they may be.

*Niobium Oxide Capacitors are manufactured and sold under patent license from Cabot Corporation, Boyertown, Pennsylvania U.S.A.





TAJ, TPS, TRJ, THJ, TPM, TAC, TPC, TLC, TLJ, TCJ, CWR11, TBJ, TBM, NOJ, NOS, NOM, NBJ, NBM, and NPV Series – Tape & Reel Packaging

Tape and reel packaging for automatic component placement. Please enter required Suffix on order. Bulk packaging is not available.

TAPE SPECIFICATION

Tape dimensions comply to EIA 481-1 Dimensions A₀ and B₀ of the pocket and the tape thickness, K, are dependent on the component size. Tape materials do not affect component solderability during storage. Carrier Tape Thickness <0.4mm.

TAPING SUFFIX TABLE TAJ, TPS, TRJ, THJ, TPM, TLJ, TCJ, CWR11, TBJ, TBM, NOJ, NOS, NOM, NBJ, NBM AND NPV

Case Size	Tape width mm	P mm	180mm (7") reel		330mm (13") reel		180mm (7") reel & Gold Termination	
			Suffix	Qty.	Suffix	Qty.	Suffix	Qty.
A	8	4	R	2000	S	8000	A	2000
B	8	4	R	2000	S	8000	A	2000
C	12	8	R	500	S	3000	A	500
D	12	8	R	500	S	2500	A	500
E	12	8	R	400	S	1500	A	400
F	12	8	R	1000	S	4000	A	1000
G	8	4	R	2500	S	10000	A	2500
H	8	4	R	2500	S	10000	A	2500
J	8	4	R	4000	S	15000	A	4000
K	8	4	R	3000	S	13000	A	2500
P	8	4	R	2500	S	10000	A	2500
R	8	4	R	2500	S	10000	A	2500
S	8	4	R	2500	S	10000	A	2500
T	8	4	R	2500	S	10000	A	2500
V	12	8	R	400	S	1500	A	400
W	12	8	R	1000	S	5000	A	1000
X	12	8	R	1000	S	5000	A	1000
Y	12	8	R	1000	S	4000	A	1000
Z	16	8	R	400	S	1500	-	-

Under Development

TAPING SUFFIX TABLE TAC, TPC, TMC AND TLC

Case Size	Tape width mm	P mm	100mm (4") reel Tin Termination		180mm (7") reel Tin Termination		100mm (4") reel & Gold Termination		180mm (7") reel & 100% Gold Termination	
			Suffix	Qty.	Suffix	Qty.	Suffix	Qty.	Suffix	Qty.
A	8	4	XTA	500	RTA	2,000	FTA	500	ATA	2,000
C	8	4	XTA	500	RTA	3,500	-	-	-	-
H	8	4	XTA	500	RTA	3,500	FTA	500	ATA	3,500
J	8	4	XTA	500	RTA	3,500	-	-	-	-
K	8	2	QTA	1000	PTA	10,000	-	-	-	-
L	8	4	XTA	500	RTA	3,500	FTA	500	ATA	3,500
R	8	4	XTA	500	RTA	2,500	FTA	500	ATA	2,500
T	8	4	XTA	500	RTA	2,500	-	-	-	-
U	8	4	XTA	500	RTA	3,500	FTA	500	ATA	3,500
V	8	4	XTA	500	RTA	2,500	-	-	-	-
X	8	4	XTA	500	RTA	2,000	FTA	500	ATA	2,000

TAJ, TPS, TRJ, THJ, TPM, TAC, TPC, TLC, TLJ, TCJ, CWR11, TBJ, TBM, NOJ, NOS, NOM, NBJ, NBM, and NPV Series – Tape & Reel Packaging



PLASTIC TAPE DIMENSIONS TAJ, TPS, TRJ, THJ, TPM, TLJ, TCJ, CWR11, TBJ, TBM, NOJ, NOS, NOM, NBJ, NBM AND NPV

Case	A0±0.10	B0±0.10	K±0.10	W±0.30	E±0.10	F±0.05	G min.	P±0.10	P2±0.05	P0±0.10	D0 ^{+0.20} _{-0.00}	D1 ^{+0.20} _{-0.00}
A	1.83	3.57	1.87	8.00	1.75	3.50	0.75	4.00	2.00	4.00	1.50	1.00
B	3.15	3.77	2.22	8.00	1.75	3.50	0.75	4.00	2.00	4.00	1.50	1.00
C	3.45	6.40	2.92	12.00	1.75	5.50	0.75	8.00	2.00	4.00	1.50	1.50
D	4.48	7.62	3.22	12.00	1.75	5.50	0.75	8.00	2.00	4.00	1.50	1.50
E	4.50	7.50	4.50	12.00	1.75	5.50	0.75	8.00	2.00	4.00	1.50	1.50
F	3.35	6.40	2.20	12.00	1.75	5.50	0.75	8.00	2.00	4.00	1.50	1.50
G	1.83	3.57	1.65	8.00	1.75	3.50	0.75	4.00	2.00	4.00	1.50	1.00
H	3.15	3.77	1.66	8.00	1.75	3.50	0.75	4.00	2.00	4.00	1.50	1.00
J	1±0.05	1.8±0.05	1±0.05	8.00	1.75	3.50	0.75	4.00	2.00	4.00	1.50	1.00
K	1.95	3.55	1.15	8.00	1.75	3.50	0.75	4.00	2.00	4.00	1.50	1.00
P	1.65	2.45	1.60	8.00	1.75	3.50	0.75	4.00	2.00	4.00	1.50	1.00
R	1.65	2.45	1.30	8.00	1.75	3.50	0.75	4.00	2.00	4.00	1.50	1.00
S	1.95	3.55	1.30	8.00	1.75	3.50	0.75	4.00	2.00	4.00	1.50	1.00
T	3.20	3.80	1.30	8.00	1.75	3.50	0.75	4.00	2.00	4.00	1.50	1.00
V	6.43	7.44	3.84	12.00	1.75	5.50	0.75	8.00	2.00	4.00	1.50	1.50
W	3.57	6.40	1.65	12.00	1.75	5.50	0.75	8.00	2.00	4.00	1.50	1.50
X	4.67	7.62	1.65	12.00	1.75	5.50	0.75	8.00	2.00	4.00	1.50	1.50
Y	4.67	7.62	2.15	12.00	1.75	5.50	0.75	8.00	2.00	4.00	1.50	1.50

PLASTIC TAPE DIMENSIONS TAC, TPC, TMC AND TLC

Case	A0±0.10	B0±0.10	K±0.10	W±0.30	E±0.10	F±0.05	G min.	P±0.10	P2±0.05	P0±0.10	D0 ^{+0.20} _{-0.00}	D1 ^{+0.20} _{-0.00}
K	0.75 ^{+0.05} _{-0.00}	1.26 ^{+0.10} _{-0.00}	0.67 ^{+0.10} _{-0.00}	8.00	1.75	3.50	0.75	2.00	2.00	2.00	1.50	0.50
Z	0.75 ^{+0.05} _{-0.00}	1.90 ^{+0.10} _{-0.00}	0.67 ^{+0.10} _{-0.00}	8.00	1.75	3.50	0.75	2.00	2.00	2.00	1.50	0.50
J	1.05 ^{+0.10} _{-0.00}	1.90 ^{+0.10} _{-0.00}	0.80 ^{+0.10} _{-0.00}	8.00	1.75	3.50	0.75	4.00	2.00	4.00	1.50	0.80
L	1.05 ^{+0.10} _{-0.00}	1.90 ^{+0.10} _{-0.00}	1.05 ^{+0.10} _{-0.00}	8.00	1.75	3.50	0.75	4.00	2.00	4.00	1.50	0.80
M	1.05 ^{+0.10} _{-0.00}	2.45±0.10	1.05 ^{+0.10} _{-0.00}	8.00	1.75	3.50	0.75	4.00	2.00	4.00	1.50	0.80
U	1.65±0.10	2.45±0.10	0.80±0.05	8.00	1.75	3.50	0.75	4.00	2.00	4.00	1.50	1.00
H	1.65±0.10	2.45±0.10	1.10±0.05	8.00	1.75	3.50	0.75	4.00	2.00	4.00	1.50	1.00
Q	1.65±0.10	2.45±0.10	1.30±0.10	8.00	1.75	3.50	0.75	4.00	2.00	4.00	1.50	1.00
R	1.65±0.10	2.45±0.10	1.60±0.10	8.00	1.75	3.50	0.75	4.00	2.00	4.00	1.50	1.00
V	1.95±0.10	3.60±0.10	0.90±0.10	8.00	1.75	3.50	0.75	4.00	2.00	4.00	1.50	1.00
C	1.95±0.10	3.55±0.10	1.15±0.10	8.00	1.75	3.50	0.75	4.00	2.00	4.00	1.50	1.00
S	1.95±0.10	3.55±0.10	1.30±0.10	8.00	1.75	3.50	0.75	4.00	2.00	4.00	1.50	1.00
A	1.83±0.10	3.57±0.10	1.87±0.10	8.00	1.75	3.50	0.75	4.00	2.00	4.00	1.50	1.00
X	1.83±0.10	3.57±0.10	1.87±0.10	8.00	1.75	3.50	0.75	4.00	2.00	4.00	1.50	1.00
T	3.20±0.10	3.80±0.10	1.30±0.10	8.00	1.75	3.50	0.75	4.00	2.00	4.00	1.50	1.00
B	3.15±0.10	3.77±0.10	1.66±0.10	8.00	1.75	3.50	0.75	4.00	2.00	4.00	1.50	1.00

Under development

TAJ, TPS, TRJ, THJ, TPM, TAC, TPC, **AVX** TLJ and TCJ Series – Tape and Reel Packaging

REEL DIMENSIONS

Reel Size	Tape	A	B	C	W	t
180mm (7")	12mm	178±2.00	50 min	13.0±0.50	12.4+1.5/-0	1.50±0.50
180mm (7")	8mm	178±2.00	50 min	13.0±0.50	8.4+1.5/-0	1.50±0.50
330mm (13")	12mm	328±2.00	50 min	13.0±0.50	12.4+1.5/-0	1.50±0.50
330mm (13")	8mm	328±2.00	50 min	13.0±0.50	8.4+1.5/-0	1.50±0.50
108mm (4.25")	8mm	108±2.00		13.0±0.50	8.4+1.5/-0	1.50±0.50

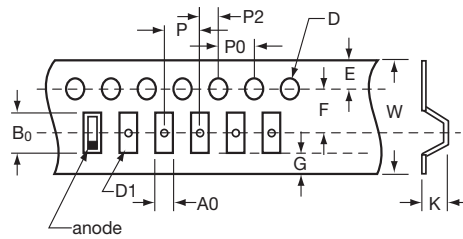
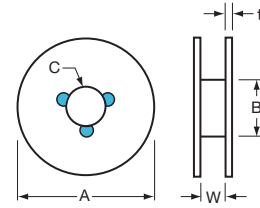

COVER TAPE NOMINAL DIMENSIONS

Thickness: 75µm
 Width of tape: 5.5mm (8mm tape)
 9.5mm (12mm tape)

TAZ Cots+, CWR09, CWR19 and CWR29 Series



Tape and Reel Packaging

Solid Tantalum Chip TAZ Tape and reel packaging for automatic component placement.
Please enter required Suffix on order. Bulk packaging is standard.

TAZ TAPING SUFFIX TABLE

Case Size reference	Tape width mm	P mm	7" (180mm) reel		13" reel (330mm) reel	
			Suffix	Qty.	Suffix	Qty.
A	8	4	R	2500	S	9000
B	12	4	R	2500	S	9000
C	12	4	R	2500	S	9000
D	12	4	R	2500	S	8000
E	12	4	R	2500	S	8000
F	12	8	R	1000	S	3000
G	12	8	R	500	S	2500
H	12	8	R	500	S	2500

Total Tape Thickness — K max	
Case size reference	TAZ Millimeters (Inches) DIM
A	2.0 (0.079)
B	4.0 (0.157)
D	4.0 (0.157)
E	4.0 (0.157)
F	4.0 (0.157)
G	4.0 (0.157)
H	4.0 (0.157)

Code	8mm Tape		12mm Tape	
P*	4±0.1 or 8±0.1	(0.157±0.004) (0.315±0.004)	4±0.1 or 8±0.1	(0.157±0.004) (0.315±0.004)
G	0.75 min	(0.03 min)	0.75 min	(0.03 min)
F	3.5±0.04	(0.138±0.002)	5.5±0.05	(0.22±0.002)
E	1.75±0.1	(0.069±0.004)	1.75±0.1	(0.069±0.004)
W	8±0.3	(0.315±0.012)	12±0.3	(0.472±0.012)
P ₂	2±0.05	(0.079±0.002)	2±0.05	(0.079±0.002)
P ₀	4±0.1	(0.157±0.004)	4±0.1	(0.157±0.004)
D	1.5±0.1 -0	(0.059±0.004) (-0)	1.5±0.1 -0	(0.059±0.004) (-0)
D ₁	1.0 min	(0.039 min)	1.5 min	(0.059 min)

*See taping suffix tables for actual P dimension (component pitch).

TAPE SPECIFICATION

Tape dimensions comply to EIA RS 481 A
Dimensions A₀ and B₀ of the pocket and the tape thickness, K, are dependent on the component size.

Tape materials do not affect component solderability during storage.

Carrier Tape Thickness <0.4mm

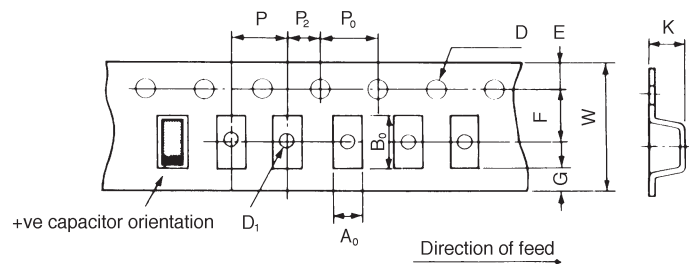

TAJ, TRJ, THJ, TPS, TPM, NOJ, NOS, NOM, NPV, TAC, TPC, TCJ and TLJ



Marking

For TAJ, TPS & THJ, the positive end of body has videcon readable polarity marking as shown in the diagram. Bodies are marked by indelible laser marking on top surface with capacitance value, voltage and LOT code. R and P case is an exception due to small size in which only the voltage and capacitance values are printed.

Voltage Code	Rated Voltage at 85°C	Voltage Code	Rated Voltage at 85°C
x	1.8	C	16
e	2.5	D	20
G	4	E	25
J	6.3	V	35
A	10	T	50

TAJ, TRJ, TPS, TPM – A, B, C, D, E, F, K, H, S, T, V, W, Y and X CASE:

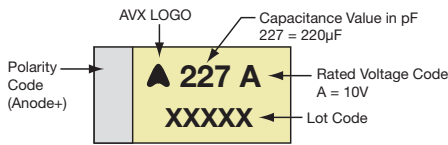

NOJ, NOS, NOM, NPV – A, B, C, D, E, S, T, V, Y, Z CASE:

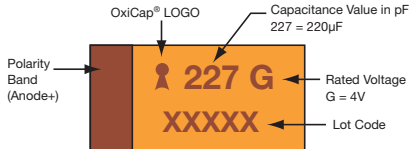

TCJ – P, R CASE:

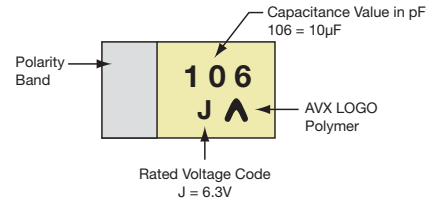

TAJ – J CASE:

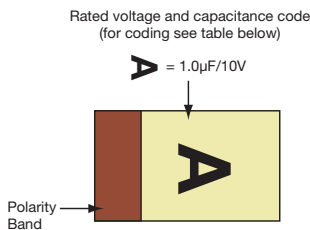

Capacitance	Voltage		
	4V	6.3V	10V
1.0			▷
1.5			▽
2.2			◁
3.3		J	A
4.7	G	J	
6.8	G	L	
10	Q		

NOJ – P CASE:

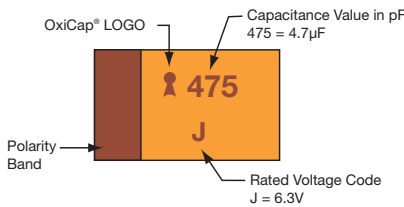

TLJ – A, B, G, H, K, S, T, W CASE:

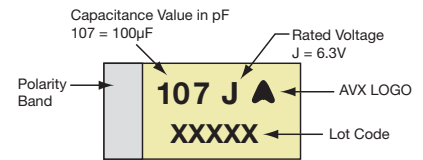

TAC, TPC – ALL CASE SIZES

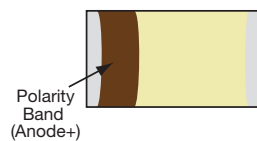

TLJ – J CASE:

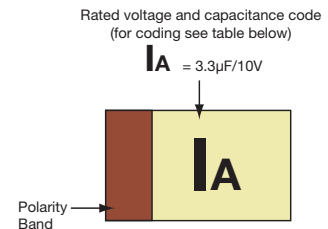

TAJ – R and P CASE:

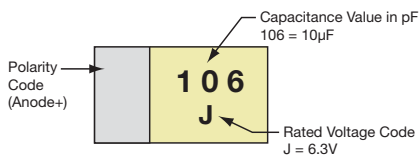

TLJ – N, P, R CASE:

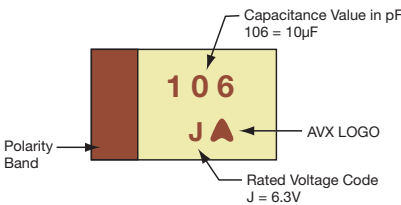

Capacitance	Voltage			
	4V	6.3V	10V	16V
2.2				
3.3			IA	Q
4.7		IJ	LA	QI
6.8	IG	Q	VI	
10	QI	QI	LI	
15		Q		
22	IG			

THJ – A, B, C, D, E CASE:

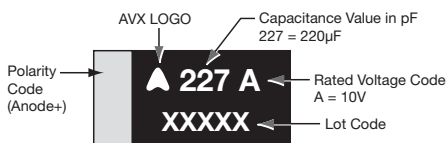

TCJ – A, B, C, H, K, T, W, Y CASE:

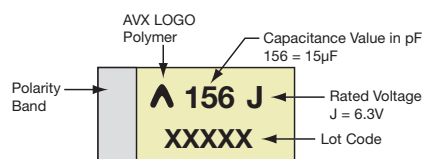

Section 5: Technical Summary and Application Guidelines



INTRODUCTION

Tantalum capacitors are manufactured from a powder of pure tantalum metal. OxiCap® - niobium oxide capacitor is made from niobium oxide NbO powder. The typical particle size is between 2 and 10 μm.

Figure below shows typical powders. Note the very great difference in particle size between the powder CVs/g.

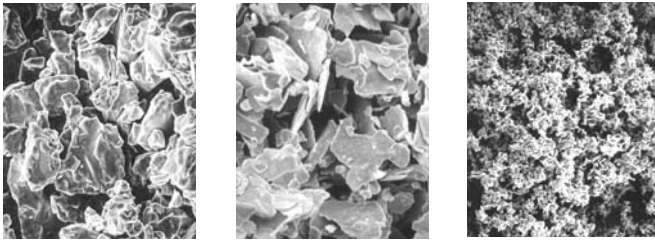

4000μFV

20000μFV

50000μFV

Figure 1a. Tantalum powder

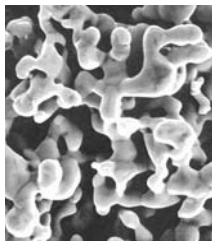

Figure 1b. Niobium Oxide powder

The powder is compressed under high pressure around a Tantalum or Niobium wire (known as the Riser Wire) to form a “pellet”. The riser wire is the anode connection to the capacitor.

This is subsequently vacuum sintered at high temperature (typically 1200 - 1800°C) which produces a mechanically strong pellet and drives off any impurities within the powder.

During sintering the powder becomes a sponge like structure with all the particles interconnected in a huge lattice.

This structure is of high mechanical strength and density, but is also highly porous giving a large internal surface area (see Figure 2).

The larger the surface area the larger the capacitance. Thus high CV/g (capacitance voltage product per gram) powders, which have a low average particle size, are used for low voltage, high capacitance parts.

By choosing which powder and sinter temperature is used to produce each capacitance/voltage rating the surface area can be controlled.

The following example uses a 220μF 6V capacitor to illustrate the point.

$$C = \frac{\epsilon_0 \epsilon_r A}{d}$$

where ϵ_0 is the dielectric constant of free space (8.855 x 10⁻¹² Farads/m)

ϵ_r is the relative dielectric constant

= 27 for Tantalum Pentoxide

= 41 for Niobium Pentoxide

d is the dielectric thickness in meters

C is the capacitance in Farads

and A is the surface area in meters

Rearranging this equation gives:

$$A = \frac{Cd}{\epsilon_0 \epsilon_r}$$

thus for a 220μF/6V capacitor the surface area is 346 square centimeters, or nearly a half times the size of this page.

The dielectric is then formed over all the Tantalum or niobium oxide surfaces by the electrochemical process of anodization. To activate this, the “pellet” is dipped into a very weak solution of phosphoric acid.

The dielectric thickness is controlled by the voltage applied during the forming process. Initially the power supply is kept in a constant current mode until the correct thickness of dielectric has been reached (that is the voltage reaches the ‘forming voltage’), it then switches to constant voltage mode and the current decays to close to zero.

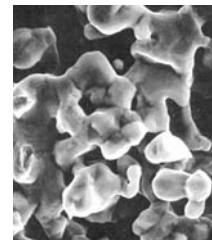
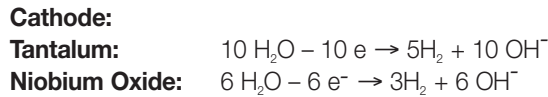
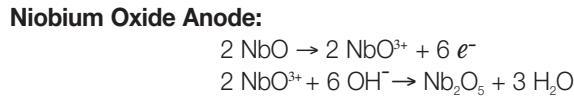
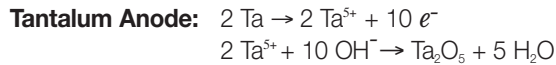

Figure 2. Sintered Anode

Technical Summary and Application Guidelines



The chemical equations describing the process are as follows:



The oxide forms on the surface of the Tantalum or Niobium Oxide but it also grows into the material. For each unit of oxide two thirds grows out and one third grows in. It is for this reason that there is a limit on the maximum voltage rating of Tantalum & Niobium Oxide capacitors with present technology powders (see Figure 3).

The dielectric operates under high electrical stress. Consider a 220µF 6V part:

Formation voltage = Formation Ratio x Working Voltage
 = 3.5 x 6
 = 21 Volts

Tantalum:
 The pentoxide (Ta_2O_5) dielectric grows at a rate of 1.7×10^{-9} m/V

Dielectric thickness (d) = $21 \times 1.7 \times 10^{-9}$
 = 0.036 µm

Electric Field strength = Working Voltage / d
 = 167 KV/mm

Niobium Oxide:
 The niobium oxide (Nb_2O_5) dielectric grows at a rate of 2.4×10^{-9} m/V

Dielectric thickness (d) = $21 \times 2.4 \times 10^{-9}$
 = 0.050 µm

Electric Field strength = Working Voltage / d
 = 120 KV/mm

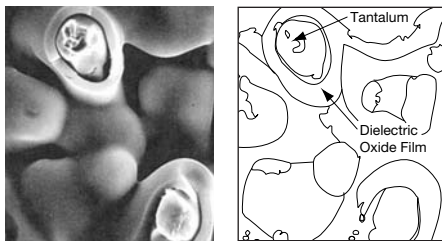

Figure 3. Dielectric layer

The next stage is the production of the cathode plate. This is achieved by pyrolysis of Manganese Nitrate into Manganese Dioxide.

The “pellet” is dipped into an aqueous solution of nitrate and then baked in an oven at approximately 250°C to produce the dioxide coat. The chemical equation is:



This process is repeated several times through varying specific densities of nitrate to build up a thick coat over all internal and external surfaces of the “pellet”, as shown in Figure 4.

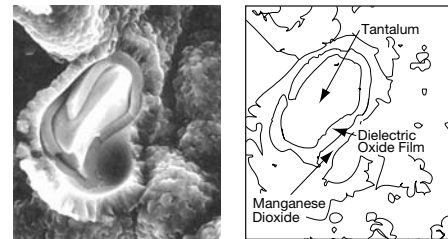

Figure 4. Manganese Dioxide Layer

The “pellet” is then dipped into graphite and silver to provide a good connection to the Manganese Dioxide cathode plate. Electrical contact is established by deposition of carbon onto the surface of the cathode. The carbon is then coated with a conductive material to facilitate connection to the cathode termination (see Figure 5). Packaging is carried out to meet individual specifications and customer requirements. This manufacturing technique is adhered to for the whole range of AVX Tantalum capacitors, which can be subdivided into four basic groups: Chip / Resin dipped / Rectangular boxed / Axial.

Further information on production of Tantalum Capacitors can be obtained from the technical paper “Basic Tantalum Technology”, by John Gill, available from your local AVX representative.

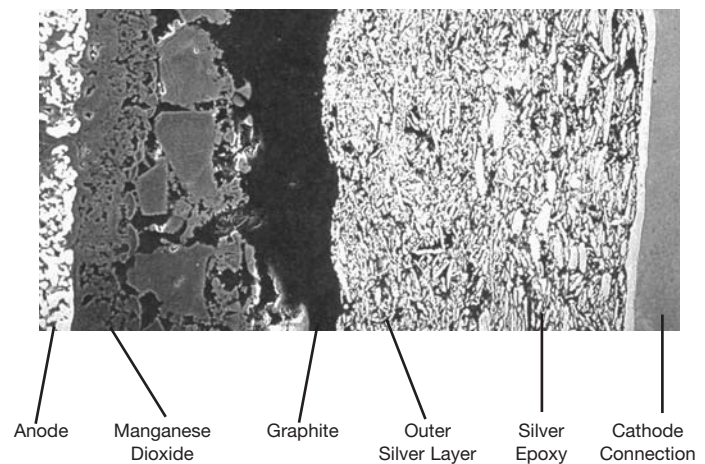

Figure 5. Cathode Termination

SECTION 1 ELECTRICAL CHARACTERISTICS AND EXPLANATION OF TERMS

1.1 CAPACITANCE

1.1.1 Rated capacitance (C_R).

This is the nominal rated capacitance. For tantalum and OxiCap® capacitors it is measured as the capacitance of the equivalent series circuit at 25°C using a measuring bridge supplied by a 0.5V rms 120Hz sinusoidal signal, free of harmonics with a bias of 2.2Vd.c.

1.1.2 Capacitance tolerance.

This is the permissible variation of the actual value of the capacitance from the rated value. For additional reading, please consult the AVX technical publication "Capacitance Tolerances for Solid Tantalum Capacitors".

1.1.3 Temperature dependence of capacitance.

The capacitance of a tantalum capacitor varies with temperature. This variation itself is dependent to a small extent on the rated voltage and capacitor size.

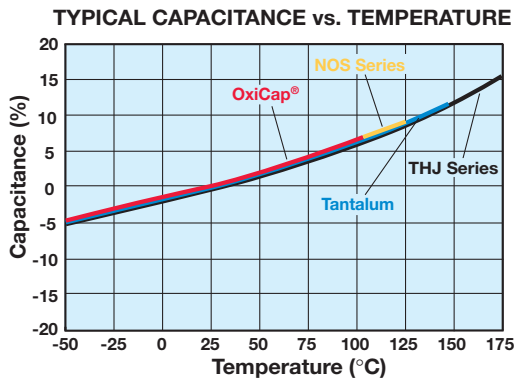

1.1.4 Frequency dependence of the capacitance.

The effective capacitance decreases as frequency increases. Beyond 100kHz the capacitance continues to drop until resonance is reached (typically between 0.5 - 5MHz depending on the rating). Beyond the resonant frequency the device becomes inductive.

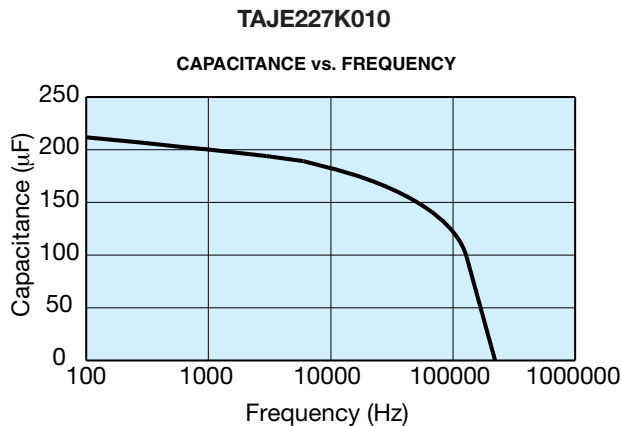

For individual part number please refer to SpiTan Software for frequency and temperature behavior found on AVX Corporation website.

1.2 VOLTAGE

1.2.1 Rated d.c. voltage (V_R).

This is the rated d.c. voltage for continuous operation at 85°C.

1.2.2 Category voltage (V_C).

This is the maximum voltage that may be applied continuously to a capacitor. It is equal to the rated voltage up to +85°C, beyond which it is subject to a linear derating, to 2/3 V_R at 125°C for tantalum and 2/3 V_R at 105°C for OxiCap®.

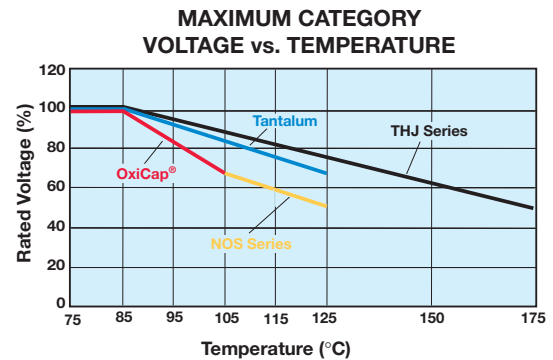

1.2.3 Surge voltage (V_S).

This is the highest voltage that may be applied to a capacitor for short periods of time in circuits with minimum series resistance of 330ohms (CECC states 1kΩ). The surge voltage may be applied up to 10 times in an hour for periods of up to 30 seconds at a time. The surge voltage must not be used as a parameter in the design of circuits in which, in the normal course of operation, the capacitor is periodically charged and discharged.

85°C Tantalum		125°C Tantalum*	
Rated Voltage V_R	Surge Voltage V_S	Category Voltage V_C	Surge Voltage V_S
2.5	3.3	1.7	2.2
4	5.2	2.7	3.4
6.3	8	4	5
10	13	7	8
16	20	10	13
20	26	13	16
25	32	17	20
35	46	23	28
50	65	33	40

85°C OxiCap®		105°C OxiCap®	
Rated Voltage V_R	Surge Voltage V_S	Category Voltage V_C	Surge Voltage V_S
1.8	2.3	1.2	1.6
2.5	3.3	1.7	2.2
4	5.2	2.7	3.4
6.3	8	4	5
10	13	7	8

*For THJ 150°C Category & Surge voltage see THJ section on pages 46-48.

1.2.4 Effect of surges

The solid Tantalum and OxiCap® capacitors have a limited ability to withstand voltage and current surges. This is in common with all other electrolytic capacitors and is due to the fact that they operate under very high electrical stress across the dielectric. For example a 6 volt tantalum capacitor has an Electrical Field of 167 kV/mm when operated at rated voltage. OxiCap® capacitors operate at electrical field significantly less than 167 kV/mm.

It is important to ensure that the voltage across the terminals of the capacitor never exceeds the specified surge voltage rating.

Solid tantalum capacitors and OxiCap® have a self healing ability provided by the Manganese Dioxide semiconducting layer used as the negative plate. However, this is limited in low impedance applications. In the case of low impedance circuits, the capacitor is likely to be stressed by current surges.

Derating the capacitor increases the reliability of the component. (See Figure 2b page 152). The “AVX Recommended Derating Table” (page 154) summarizes voltage rating for use on common voltage rails, in low impedance applications for both Tantalum and OxiCap® capacitors.

In circuits which undergo rapid charge or discharge a protective resistor of $1\Omega/V$ is recommended. If this is impossible, a derating factor of up to 70% should be used on tantalum capacitors. OxiCap® capacitors can be used with derating of 20% minimum.

In such situations a higher voltage may be needed than is available as a single capacitor. A series combination should be used to increase the working voltage of the equivalent capacitor: For example, two 22 μ F 25V parts in series is equivalent to one 11 μ F 50V part. For further details refer to J.A. Gill's paper “Investigation into the Effects of Connecting Tantalum Capacitors in Series”, available from AVX offices worldwide.

NOTE:

While testing a circuit (e.g. at ICT or functional) it is likely that the capacitors will be subjected to large voltage and current transients, which will not be seen in normal use. These conditions should be borne in mind when considering the capacitor's rated voltage for use. These can be controlled by ensuring a correct test resistance is used.

1.2.5 Reverse voltage and Non-Polar operation.

The values quoted are the maximum levels of reverse voltage which should appear on the capacitors at any time. These limits are based on the assumption that the capacitors are polarized in the correct direction for the majority of their working life. They are intended to cover short term reversals of polarity such as those occurring during switching transients or during a minor portion of an impressed waveform. Continuous application of reverse voltage without normal polarization will result in a degradation of leakage current. In conditions under which continuous application of a reverse

voltage could occur two similar capacitors should be used in a back-to-back configuration with the negative terminations connected together. Under most conditions this combination will have a capacitance one half of the nominal capacitance of either capacitor. Under conditions of isolated pulses or during the first few cycles, the capacitance may approach the full nominal value. The reverse voltage ratings are designed to cover exceptional conditions of small level excursions into incorrect polarity. The values quoted are not intended to cover continuous reverse operation.

The peak reverse voltage applied to the capacitor must not exceed:

10% of the rated d.c. working voltage to a maximum of 1.0v at 25°C

3% of the rated d.c. working voltage to a maximum of 0.5v at 85°C

1% of the rated d.c. working voltage to a maximum of 0.1v at 125°C (0.1v at 150°C THJ Series)

Note: Capacitance and DF values of OxiCap® may exceed specification limits under these conditions.

LEAKAGE CURRENT vs. BIAS VOLTAGE

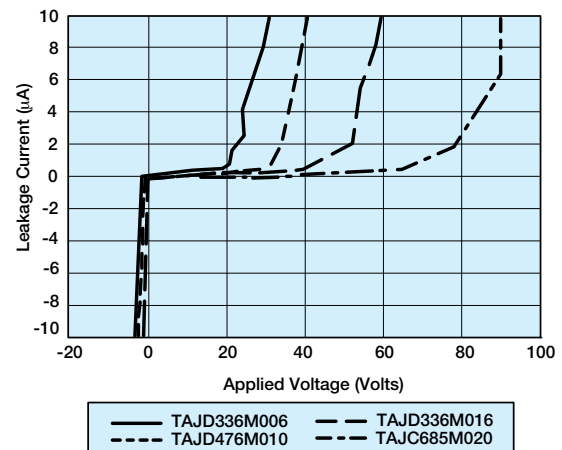

1.2.6 Superimposed A.C. Voltage (Vr.m.s.) - Ripple Voltage.

This is the maximum r.m.s. alternating voltage; superimposed on a d.c. voltage, that may be applied to a capacitor. The sum of the d.c. voltage and peak value of the superimposed a.c. voltage must not exceed the category voltage, v.c.

Full details are given in Section 2.

1.2.7 Forming voltage.

This is the voltage at which the anode oxide is formed. The thickness of this oxide layer is proportional to the formation voltage for a capacitor and is a factor in setting the rated voltage.

1.3 DISSIPATION FACTOR AND TANGENT OF LOSS ANGLE (TAN δ)

1.3.1 Dissipation factor (D.F.).

Dissipation factor is the measurement of the tangent of the loss angle ($\tan \delta$) expressed as a percentage. The measurement of DF is carried out using a measuring bridge that supplies a 0.5V rms 120Hz sinusoidal signal, free of harmonics with a bias of 2.2Vdc. The value of DF is temperature and frequency dependent.

Note: For surface mounted products the maximum allowed DF values are indicated in the ratings table and it is important to note that these are the limits met by the component AFTER soldering onto the substrate.

1.3.2 Tangent of Loss Angle ($\tan \delta$).

This is a measurement of the energy loss in the capacitor. It is expressed, as $\tan \delta$ and is the power loss of the capacitor divided by its reactive power at a sinusoidal voltage of specified frequency. Terms also used are power factor, loss factor and dielectric loss. $\cos(90 - \delta)$ is the true power factor. The measurement of $\tan \delta$ is carried out using a measuring bridge that supplies a 0.5V rms 120Hz sinusoidal signal, free of harmonics with a bias of 2.2Vdc.

1.3.3 Frequency dependence of Dissipation Factor.

Dissipation Factor increases with frequency as shown in the typical curves that are for tantalum and OxiCap® capacitors identical:

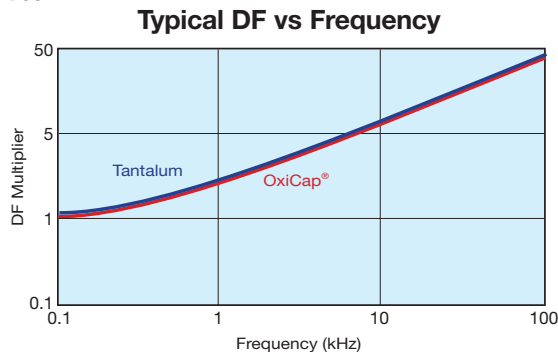

1.3.4 Temperature dependence of Dissipation Factor.

Dissipation factor varies with temperature as the typical curves show. These plots are identical for both Tantalum and OxiCap® capacitors. For maximum limits please refer to ratings tables.

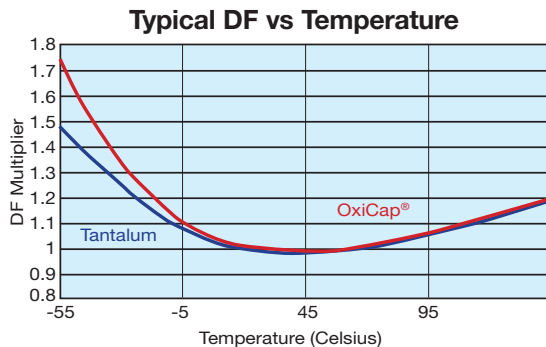

1.4 IMPEDANCE, (Z) AND EQUIVALENT SERIES RESISTANCE (ESR)

1.4.1 Impedance, Z.

This is the ratio of voltage to current at a specified frequency. Three factors contribute to the impedance of a Tantalum capacitor; the resistance of the semiconductor layer; the capacitance value and the inductance of the electrodes and leads.

At high frequencies the inductance of the leads becomes a limiting factor. The temperature and frequency behavior of these three factors of impedance determine the behavior of the impedance Z. The impedance is measured at 25°C and 100kHz.

1.4.2 Equivalent Series Resistance, ESR.

Resistance losses occur in all practical forms of capacitors. These are made up from several different mechanisms, including resistance in components and contacts, viscous forces within the dielectric and defects producing bypass current paths. To express the effect of these losses they are considered as the ESR of the capacitor. The ESR is frequency dependent and can be found by using the relationship;

$$ESR = \frac{\tan \delta}{2\pi fC}$$

Where f is the frequency in Hz, and C is the capacitance in farads.

The ESR is measured at 25°C and 100kHz.

ESR is one of the contributing factors to impedance, and at high frequencies (100kHz and above) it becomes the dominant factor. Thus ESR and impedance become almost identical, impedance being only marginally higher.

1.4.3 Frequency dependence of Impedance and ESR.

ESR and Impedance both increase with decreasing frequency. At lower frequencies the values diverge as the extra contributions to impedance (due to the reactance of the capacitor) become more significant. Beyond 1MHz (and beyond the resonant point of the capacitor) impedance again increases due to the inductance of the capacitor. Typical ESR and Impedance values are similar for both tantalum and niobium oxide materials and thus the same charts are valid for both for Tantalum and OxiCap® capacitors.

Typical ESR vs Frequency

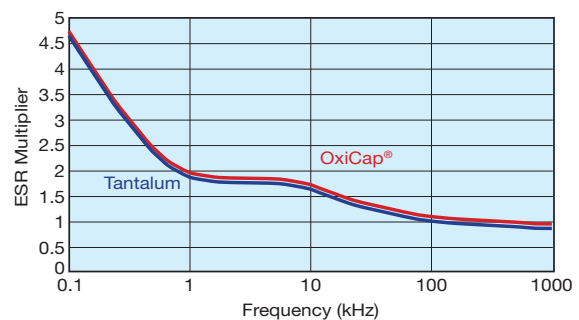

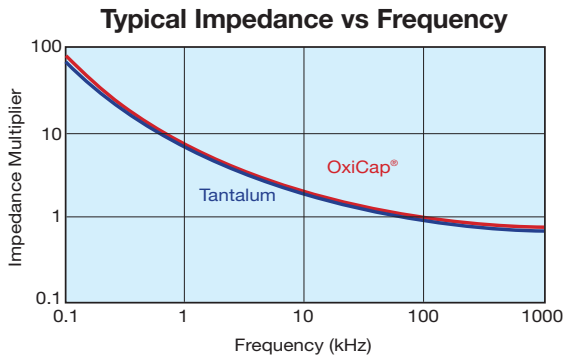

1.4.4 Temperature dependence of the Impedance and ESR.

At 100kHz, impedance and ESR behave identically and decrease with increasing temperature as the typical curves show.

Typical 100kHz ESR vs Temperature

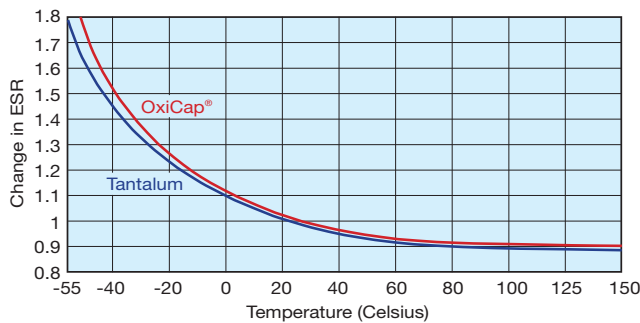

1.5 D.C. LEAKAGE CURRENT

1.5.1 Leakage current.

The leakage current is dependent on the voltage applied, the elapsed time since the voltage was applied and the component temperature. It is measured at +20°C with the rated voltage applied. A protective resistance of 1000Ω is connected in series with the capacitor in the measuring circuit. Three to five minutes after application of the rated voltage the leakage current must not exceed the maximum values indicated in the ratings table. These are based on the formula 0.01CV or 0.5μA (whichever is the greater) for tantalum and 0.02CV or 1.0μA (whichever is the greater) for OxiCap® capacitors.

Reforming of Tantalum or OxiCap® capacitors is unnecessary even after prolonged storage periods without the application of voltage.

1.5.2 Temperature dependence of the leakage current.

The leakage current increases with higher temperatures; typical values are shown in the graph. For operation between 85°C and 125°C, the maximum working voltage must be derated and can be found from the following formula.

$$V_{max} = \left(1 - \frac{T - 85}{125}\right) \times V_R$$

where T is the required operating temperature.

LEAKAGE CURRENT vs. TEMPERATURE

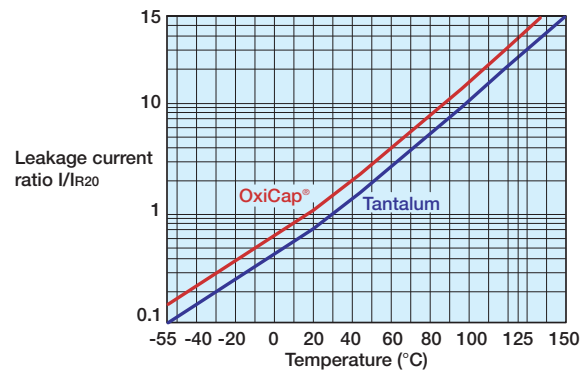

1.5.3 Voltage dependence of the leakage current.

The leakage current drops rapidly below the value corresponding to the rated voltage V_R when reduced voltages are applied. The effect of voltage derating on the leakage current is shown in the graph. This will also give a significant increase in the reliability for any application. See Section 3.1 (page 152) for details.

LEAKAGE CURRENT vs. RATED VOLTAGE

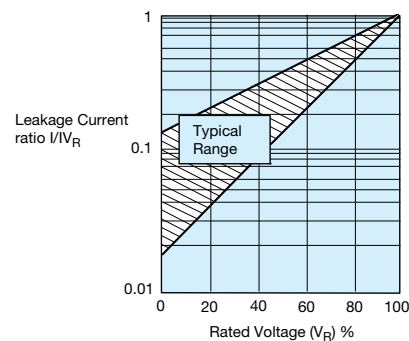

For additional information on Leakage Current, please consult the AVX technical publication "Analysis of Solid Tantalum Capacitor Leakage Current" by R. W. Franklin.

1.5.4 Ripple current.

The maximum ripple current allowed is derived from the power dissipation limits for a given temperature rise above ambient temperature (please refer to Section 2, pages 149-151).

1.6 SELF INDUCTANCE (ESL)

The self-inductance value (ESL) can be important for resonance frequency evaluation. See figure below typical ESL values per case size.

TAJ/TPS/THJ/TRJ/TLJ TCJ/CWR11/NOJ/NOS

Case Size	Typical Self-Inductance value (nH)	Case Size	Typical Self-Inductance value (nH)
A	1.8	V	2.4
B	1.8	W	2.2
C	2.2	Y	2.4
D	2.4	X	2.4
E	2.5	P	1.4
R	1.4	K	1.8
S	1.8	H	1.8
T	1.8	F	2.2

TAC

Case Size	Typical Self-Inductance value (nH)
K	1.1
L	1.2
R	1.4

TPM/NOM

Case Size	Typical Self-Inductance value (nH)
D	1.0
E	2.5
V	2.4

Technical Summary and Application Guidelines



SECTION 2 A.C. OPERATION, RIPPLE VOLTAGE AND RIPPLE CURRENT

2.1 RIPPLE RATINGS (A.C.)

In an a.c. application heat is generated within the capacitor by both the a.c. component of the signal (which will depend upon the signal form, amplitude and frequency), and by the d.c. leakage. For practical purposes the second factor is insignificant. The actual power dissipated in the capacitor is calculated using the formula:

$$P = I^2 R$$

and rearranged to $I = \text{SQRT}(P/R)$ (Eq. 1)

- where
- I = rms ripple current, amperes
 - R = equivalent series resistance, ohms
 - U = rms ripple voltage, volts
 - P = power dissipated, watts
 - Z = impedance, ohms, at frequency under consideration

Maximum a.c. ripple voltage (U_{max}).

From the Ohms' law equation:

$$U_{\text{max}} = IR \text{(Eq. 2)}$$

Where P is the maximum permissible power dissipated as listed for the product under consideration (see tables).

However care must be taken to ensure that:

1. The d.c. working voltage of the capacitor must not be exceeded by the sum of the positive peak of the applied a.c. voltage and the d.c. bias voltage.
2. The sum of the applied d.c. bias voltage and the negative peak of the a.c. voltage must not allow a voltage reversal in excess of the "Reverse Voltage".

Historical ripple calculations.

Previous ripple current and voltage values were calculated using an empirically derived power dissipation required to give a 10°C rise of the capacitors body temperature from room temperature, usually in free air. These values are shown in Table I. Equation 1 then allows the maximum ripple current to be established, and Equation 2, the maximum ripple voltage. But as has been shown in the AVX article on thermal management by I. Salisbury, the thermal conductivity of a Tantalum chip capacitor varies considerably depending upon how it is mounted.

Table I: Power Dissipation Ratings (In Free Air)

TAJ/TPS/THJ/TRJ/TPM/TCJ/TLJ/CWR11/NOJ/NOS/NOM Series Molded Chip

Case size	Max. power dissipation (W)			
	Tantalum		OxiCap®	
	TAJ/TPS/THJ/TRJ/TCJ/TLJ/CWR11	TPM	NOJ/NOS	NOM
A	0.075	—	0.090	—
B	0.085	—	0.102	—
C	0.110	—	0.132	—
D	0.150	0.255	0.180	—
E	0.165	0.270	0.198	0.324
F	0.100	—	—	—
G	0.070	—	—	—
H	0.080	—	—	—
J	0.010	—	—	—
K	0.065	—	—	—
N	0.050	—	—	—
P	0.060	—	—	—
R	0.055	—	—	—
S	0.065	—	—	—
T	0.080	—	—	—
V	0.250	0.285	0.300	—
W	0.090	—	—	—
X	0.100	—	—	—
Y	0.125	—	—	—
Z	—	0.300	—	—

TAZ/CWR09 Series Molded Chip

Case size	Max. power dissipation (W)
A	0.050
B	0.070
C	0.075
D	0.080
E	0.090
F	0.100
G	0.125
H	0.150

TAJ/TPS/THJ/TRJ/TPM TCJ/TLJ/CWR11/TAZ CWR09/TAC Series Molded Chip

Temperature correction factor for ripple current	
Temp. °C	Factor
+25	1.00
+55	0.95
+85	0.90
+125	0.40
+175 (THJ)	0.20

TACmicrochip®

Case size	Max. power dissipation (W)
A	0.040
B	0.040
H	0.040
J	0.020
K	0.015
L	0.025
M	0.030
R	0.045
T	0.040
U	0.035
V	0.035
X	0.040
Z	0.020

NOJ/NOS

Temperature correction factor for ripple current	
Temp. °C	Factor
+25	1.00
+55	0.95
+85	0.90
+105	0.40
+125 (NOS)	0.40



Technical Summary and Application Guidelines



A piece of equipment was designed which would pass sine and square wave currents of varying amplitudes through a biased capacitor. The temperature rise seen on the body for the capacitor was then measured using an infra-red probe. This ensured that there was no heat loss through any thermo-couple attached to the capacitor's surface.

Results for the C, D and E case sizes

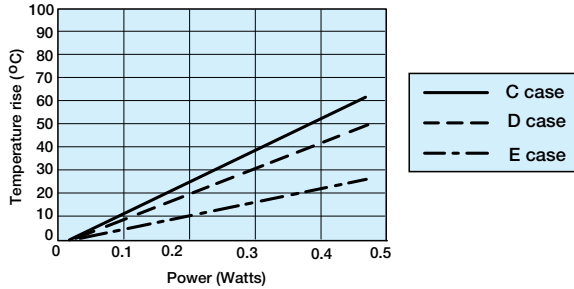

Several capacitors were tested and the combined results are shown above. All these capacitors were measured on FR4 board, with no other heat sinking. The ripple was supplied at various frequencies from 1kHz to 1MHz.

As can be seen in the figure above, the average P_{max} value for the C case capacitors was 0.11 Watts. This is the same as that quoted in Table I.

The D case capacitors gave an average P_{max} value 0.125 Watts. This is lower than the value quoted in the Table I by 0.025 Watts. The E case capacitors gave an average P_{max} of 0.200 Watts that was much higher than the 0.165 Watts from Table I.

If a typical capacitor's ESR with frequency is considered, e.g. figure below, it can be seen that there is variation. Thus for a set ripple current, the amount of power to be dissipated by the capacitor will vary with frequency. This is clearly shown in figure in top of next column, which shows that the surface temperature of the unit raises less for a given value of ripple current at 1MHz than at 100kHz.

The graph below shows a typical ESR variation with frequency. Typical ripple current versus temperature rise for 100kHz and 1MHz sine wave inputs.

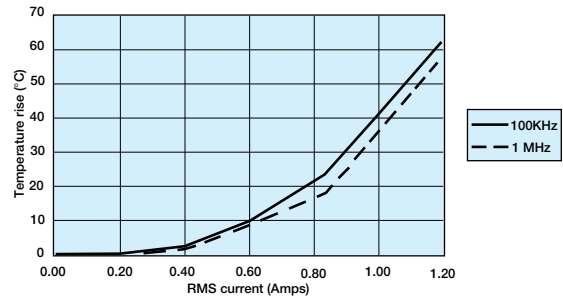
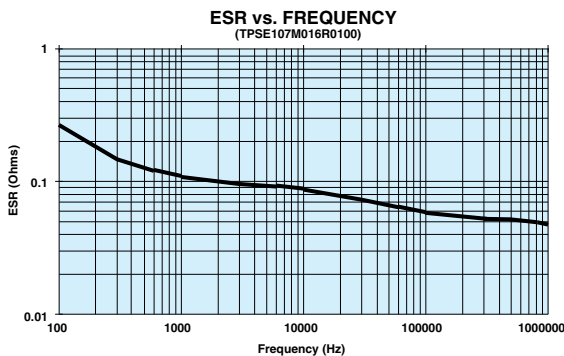

If I^2R is then plotted it can be seen that the two lines are in fact coincident, as shown in figure below.

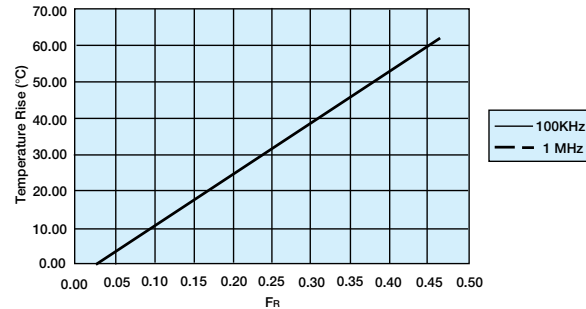

Example

A Tantalum capacitor is being used in a filtering application, where it will be required to handle a 2 Amp peak-to-peak, 200kHz square wave current.

A square wave is the sum of an infinite series of sine waves at all the odd harmonics of the square waves fundamental frequency. The equation which relates is:

$$I_{Square} = I_{pk} \sin(2\pi f) + I_{pk} \sin(6\pi f) + I_{pk} \sin(10\pi f) + I_{pk} \sin(14\pi f) + \dots$$

Thus the special components are:

Frequency	Peak-to-peak current (Amps)	RMS current (Amps)
200 KHz	2.000	0.707
600 KHz	0.667	0.236
1 MHz	0.400	0.141
1.4 MHz	0.286	0.101

Let us assume the capacitor is a TAJD686M006

Typical ESR measurements would yield.

Frequency	Typical ESR (Ohms)	Power (Watts) $I_{rms}^2 \times ESR$
200 KHz	0.120	0.060
600 KHz	0.115	0.006
1 MHz	0.090	0.002
1.4 MHz	0.100	0.001

Thus the total power dissipation would be 0.069 Watts.

From the D case results shown in figure top of previous column, it can be seen that this power would cause the capacitors surface temperature to rise by about 5°C. For additional information, please refer to the AVX technical publication "Ripple Rating of Tantalum Chip Capacitors" by R.W. Franklin.



Technical Summary and Application Guidelines



2.2 OXICAP® RIPPLE RATING

OxiCap® capacitors showing 20% higher power dissipation allowed compared to tantalum capacitors as a result of twice higher specific heat of niobium oxide compared to Tantalum

powders. (Specific heat is related to energy necessary to heat a defined volume of material to a specified temperature.)

2.3 THERMAL MANAGEMENT

The heat generated inside a tantalum capacitor in a.c. operation comes from the power dissipation due to ripple current. It is equal to I^2R , where I is the rms value of the current at a given frequency, and R is the ESR at the same frequency with an additional contribution due to the leakage current. The heat will be transferred from the outer surface by conduction. How efficiently it is transferred from this point is dependent on the thermal management of the board.

In practice, in a high density assembly with no specific thermal management, the power dissipation required to give a 10°C rise above ambient may be up to a factor of 10 less. In these cases, the actual capacitor temperature should be established (either by thermocouple probe or infra-red scanner) and if it is seen to be above this limit it may be necessary to specify a lower ESR part or a higher voltage rating.

The power dissipation ratings given in Section 2.1 (page 149) are based on free-air calculations. These ratings can be approached if efficient heat sinking and/or forced cooling is used.

Please contact application engineering for details or contact the AVX technical publication entitled "Thermal Management of Surface Mounted Tantalum Capacitors" by Ian Salisbury.

Thermal Dissipation from the Mounted Chip

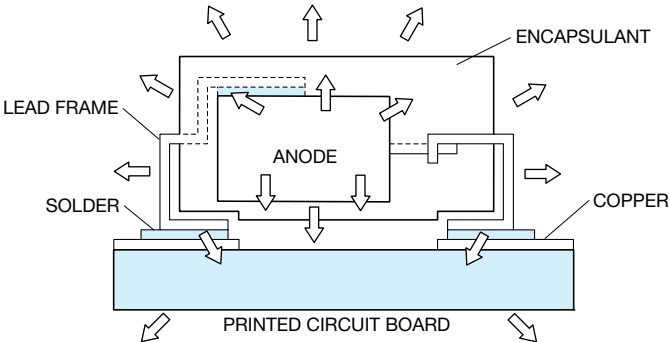

Thermal Impedance Graph with Ripple Current

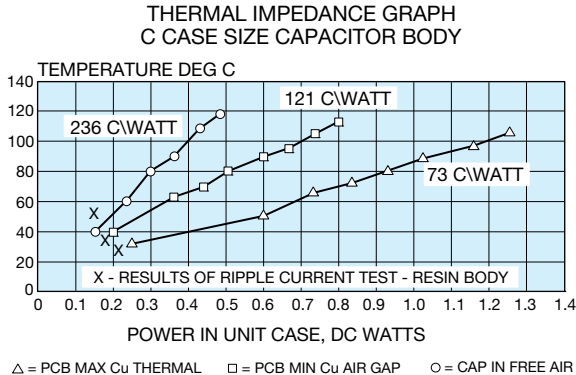

SECTION 3 RELIABILITY AND CALCULATION OF FAILURE RATE

3.1 STEADY-STATE

Both Tantalum and Niobium Oxide dielectric have essentially no wear out mechanism and in certain circumstances is capable of limited self healing. However, random failures can occur in operation. The failure rate of Tantalum capacitors will decrease with time and not increase as with other electrolytic capacitors and other electronic components.

Figure 1. Tantalum and OxiCap® Reliability Curve

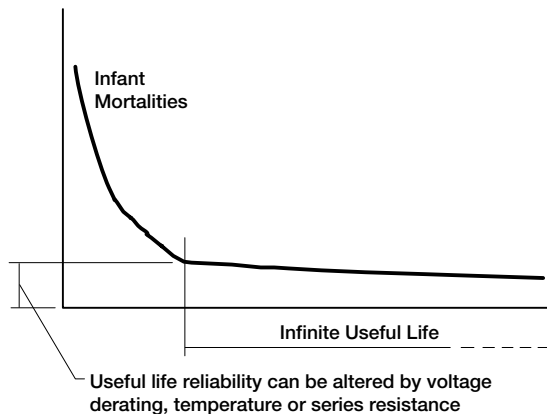

The useful life reliability of the Tantalum and OxiCap® capacitors in steady-state is affected by three factors. The equation from which the failure rate can be calculated is:

$$F = F_V \times F_T \times F_R \times F_B$$

where F_V is a correction factor due to operating voltage/voltage derating
 F_T is a correction factor due to operating temperature
 F_R is a correction factor due to circuit series resistance
 F_B is the basic failure rate level

Base failure rate.

Standard Tantalum conforms to Level M reliability (i.e. 1%/1000 hrs) or better at rated voltage, 85°C and 0.1Ω/volt circuit impedance.

$F_B = 1.0\% / 1000$ hours for TAJ, TPS, TAC, TPM and TCJ
 0.5% / 1000 hours for TRJ, THJ and NOJ
 0.2% / 1000 hours for NOS and NOM

TLJ and TLC series of tantalum capacitors are defined at 0.5 x rated voltage at 85°C due to the temperature derating.

$F_B = 0.2\% / 1000$ hours at 85°C and $0.5 \times V_R$ with 0.1Ω/V series impedance with 60% confidence level.

Operating voltage/voltage derating.

If a capacitor with a higher voltage rating than the maximum line voltage is used, then the operating reliability will be improved. This is known as voltage derating.

The graph, Figure 2a, shows the relationship between voltage derating (the ratio between applied and rated voltage) and the failure rate. The graph gives the correction factor F_V for any operating voltage.

Figure 2a. Correction factor to failure rate F_V for voltage derating of a typical component (60% con. level).

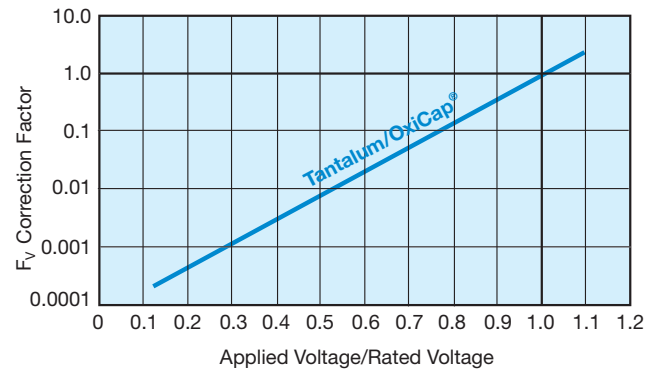

Figure 2b. Gives our recommendation for voltage derating for tantalum capacitors to be used in typical applications.

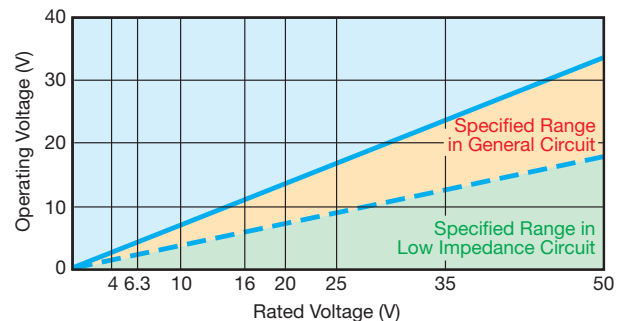
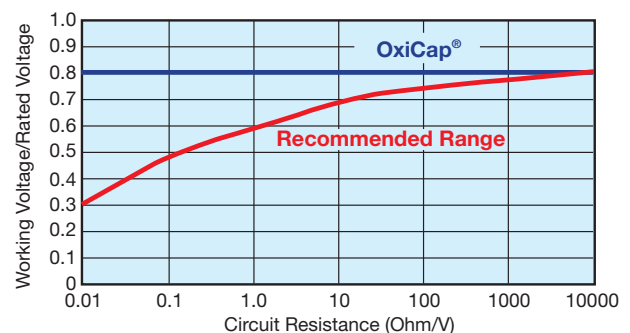

Figure 2c. Gives voltage derating recommendations for tantalum capacitors as a function of circuit impedance.



Technical Summary and Application Guidelines



Operating Temperature.

If the operating temperature is below the rated temperature for the capacitor then the operating reliability will be improved as shown in Figure 3. This graph gives a correction factor F_T for any temperature of operation.

Figure 3: Correction factor to failure rate F_R for ambient temperature T for typical component (60% con. level).

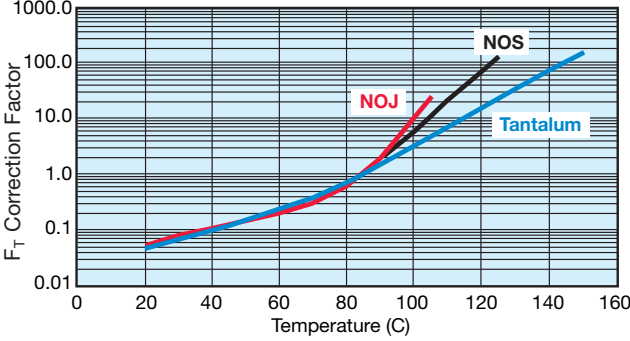

Circuit Impedance.

All solid Tantalum and/or niobium oxide capacitors require current limiting resistance to protect the dielectric from surges. A series resistor is recommended for this purpose. A lower circuit impedance may cause an increase in failure rate, especially at temperatures higher than 20°C. An inductive low impedance circuit may apply voltage surges to the capacitor and similarly a non-inductive circuit may apply current surges to the capacitor, causing localized over-heating and failure. The recommended impedance is 1 Ω per volt. Where this is not feasible, equivalent voltage derating should be used (See MIL HANDBOOK 217E). The graph, Figure 4, shows the correction factor, F_R , for increasing series resistance.

Figure 4. Correction factor to failure rate F_R for series resistance R on basic failure rate F_B for a typical component (60% con. level).

Circuit resistance ohms/volt	F_R
3.0	0.07
2.0	0.1
1.0	0.2
0.8	0.3
0.6	0.4
0.4	0.6
0.2	0.8
0.1	1.0

For circuit impedances below 0.1 ohms per volt, or for any mission critical application, circuit protection should be considered. An ideal solution would be to employ an AVX SMT thin-film fuse in series.

Example calculation.

Consider a 12 volt power line. The designer needs about 10 μ F of capacitance to act as a decoupling capacitor near a video bandwidth amplifier. Thus the circuit impedance will be limited only by the output impedance of the board's power unit and the track resistance. Let us assume it to be about 2 Ohms minimum, i.e. 0.167 Ohms/Volt. The operating temperature range is -25°C to +85°C.

If a 10 μ F 16 Volt capacitor was designed in the operating failure rate would be as follows.

- a) $F_T = 1.0$ @ 85°C
- b) $F_R = 0.85$ @ 0.167 Ohms/Volt
- c) $F_V = 0.08$ @ applied voltage/rated voltage = 75%
- d) $F_B = 1\%/1000$ hours, basic failure rate level

Thus $F = 1.0 \times 0.85 \times 0.08 \times 1 = 0.068\%/1000$ Hours

If the capacitor was changed for a 20 volt capacitor, the operating failure rate will change as shown.

$F_V = 0.018$ @ applied voltage/rated voltage = 60%
 $F = 1.0 \times 0.85 \times 0.018 \times 1 = 0.0153\%/1000$ Hours

3.2 Dynamic.

As stated in Section 1.2.4 (page 146), the solid capacitor has a limited ability to withstand voltage and current surges. Such current surges can cause a capacitor to fail. The expected failure rate cannot be calculated by a simple formula as in the case of steady-state reliability. The two parameters under the control of the circuit design engineer known to reduce the incidence of failures are derating and series resistance.

The table below summarizes the results of trials carried out at AVX with a piece of equipment, which has very low series resistance with no voltage derating applied. That is if the capacitor was tested at its rated voltage. It has been tested on tantalum capacitors, however the conclusions are valid for both tantalum and OxiCap® capacitors.

Results of production scale derating experiment

Capacitance and Voltage	Number of units tested	50% derating applied	No derating applied
47 μ F 16V	1,547,587	0.03%	1.1%
100 μ F 10V	632,876	0.01%	0.5%
22 μ F 25V	2,256,258	0.05%	0.3%

As can clearly be seen from the results of this experiment, the more derating applied by the user, the less likely the probability of a surge failure occurring.

It must be remembered that these results were derived from a highly accelerated surge test machine, and failure rates in the low ppm are more likely with the end customer.

A commonly held misconception is that the leakage current of a Tantalum capacitor can predict the number of failures which will be seen on a surge screen. This can be disproved by the results of an experiment carried out at AVX on 47 μ F

Technical Summary and Application Guidelines

10V surface mount capacitors with different leakage currents. The results are summarized in the table below.

Leakage current vs number of surge failures.

Again, it must be remembered that these results were derived from a highly accelerated surge test machine, and failure rates in the low ppm are more likely with the end customer.

	Number tested	Number failed surge
Standard leakage range 0.1 μA to 1μA	10,000	25
Over Catalog limit 5μA to 50μA	10,000	26
Classified Short Circuit 50μA to 500μA	10,000	25

OxiCap® capacitor is less sensitive to an overloading stress compared to Tantalum and so a 20% minimum derating is recommended. It may be necessary in extreme low impedance circuits of high transient or ‘switch-on’ currents to derate the voltage further. Hence in general a lower voltage OxiCap® part number can be placed on a higher rail voltage compared to the tantalum capacitor – see table below.

AVX recommended derating table.

Voltage Rail (V)	Rated Voltage of Cap (V)	
	Tantalum	OxiCap®
3.3	6.3	4
5	10	6.3
8	16	10
10	20	–
12	25	–
15	35	–
>24	Series Combination	–

For further details on surge in Tantalum capacitors refer to J.A. Gill’s paper “Surge in Solid Tantalum Capacitors”, available from AVX offices worldwide.

An added bonus of increasing the derating applied in a circuit, to improve the ability of the capacitor to withstand surge conditions, is that the steady-state reliability is improved by up to an order. Consider the example of a 6.3 volt capacitor being used on a 5 volt rail.

The steady-state reliability of a Tantalum capacitor is affected by three parameters; temperature, series resistance and voltage derating. Assume 40°C operation and 0.1 Ohms/Volt series resistance.

The capacitors reliability will therefore be:

$$\begin{aligned}
 \text{Failure rate} &= F_U \times F_T \times F_R \times 1\%/1000 \text{ hours} \\
 &= 0.15 \times 0.1 \times 1 \times 1\%/1000 \text{ hours} \\
 &= 0.015\%/1000 \text{ hours}
 \end{aligned}$$

If a 10 volt capacitor was used instead, the new scaling factor would be 0.006, thus the steady-state reliability would be:

$$\begin{aligned}
 \text{Failure rate} &= F_U \times F_T \times F_R \times 1\%/1000 \text{ hours} \\
 &= 0.006 \times 0.1 \times 1 \times 1\%/1000 \text{ hours} \\
 &= 6 \times 10^{-4} \%/1000 \text{ hours}
 \end{aligned}$$

So there is an order improvement in the capacitors steady-state reliability.

Technical Summary and Application Guidelines



SECTION 4 APPLICATION GUIDELINES FOR TANTALUM AND OXICAP® CAPACITORS

Soldering Conditions and Board Attachment.

The soldering temperature and time should be the minimum for a good connection.

A suitable combination for wavesoldering is 230°C - 250°C for 3 - 5 seconds.

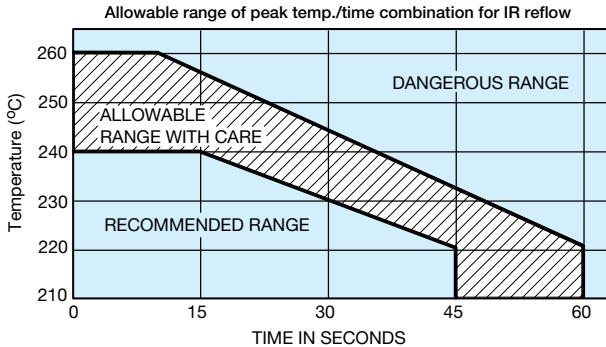

Both Tantalum and OxiCap® are lead-free system compatible components, meeting requirements of IPC/JEDEC standard J-STD-20C. The maximum conditions with care: Max. Peak Temperature: 260°C for maximum 10s, 3 reflow cycles.

For vapor phase or infra-red reflow soldering the profile below shows allowable and dangerous time/temperature combinations. The profile refers to the peak reflow temperature and is designed to ensure that the temperature of the internal construction of the capacitor does not exceed 220°C. Preheat conditions vary according to the reflow system used, maximum time and temperature would be 10 minutes at 150°C. Small parametric shifts may be noted immediately after reflow, components should be allowed to stabilize at room temperature prior to electrical testing.

Reflow profile requirements may be affected by lead environmental concerns and thus lead-free soldering system introduction within electronic industry.

Both Tantalum and OxiCap® are lead-free system compatible components. See the next section for AVX recommendation and details.

TAJ, NOJ and TAZ series are designed for reflow and wave soldering operations. In addition, these series are available with gold termination options compatible with conductive epoxy mounting. Gold finish suitable for wire bonding for hybrid assemblies are available upon request.

Under the CECC 00 802 International Specification, AVX Tantalum capacitors and OxiCap® are Class A components. The capacitors can therefore be subjected to one IR reflow, one wave solder and one soldering iron cycle. If more aggressive mounting techniques are to be used please consult AVX Tantalum for guidance.

Allowable range of peak temp./time combination for wave soldering

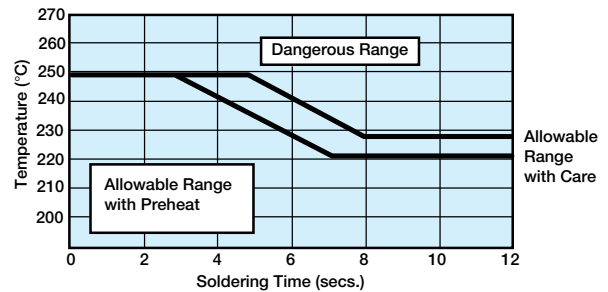

SECTION 4 (continued)

APPLICATION GUIDELINES FOR TANTALUM AND OXICAP® CAPACITORS

Recommended soldering profiles for surface mounting of tantalum capacitors is provided in figure below.

RECOMMENDED LEAD-FREE REFLOW PROFILE

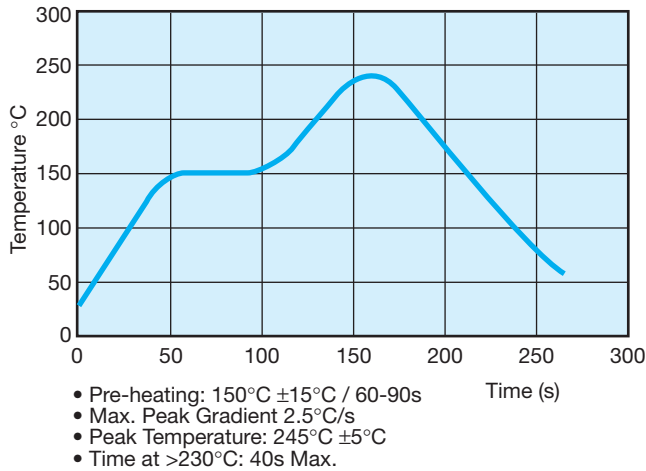

Both Tantalum and OxiCap® are lead-free system compatible components, meeting requirements of IPC/JEDEC standard J-STD-20C. The maximum conditions with care: Max. Peak Temperature: 260°C for maximum 10s, 3 reflow cycles.

WAVE SOLDERING

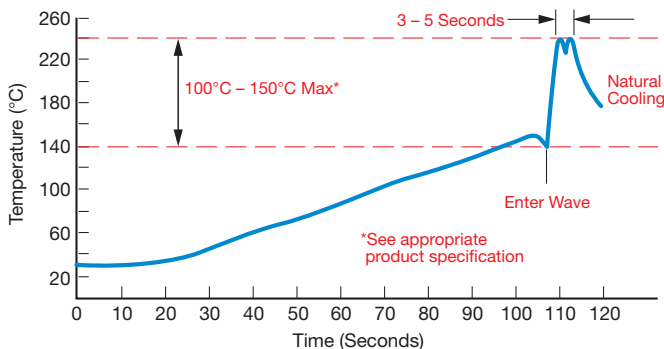

GENERAL LEAD-FREE NOTES

The following should be noted by customers changing from lead based systems to the new lead free pastes.

- The visual standards used for evaluation of solder joints will need to be modified as lead free joints are not as bright as with tin-lead pastes and the fillet may not be as large.
- Resin color may darken slightly due to the increase in temperature required for the new pastes.
- Lead-free solder pastes do not allow the same self alignment as lead containing systems. Standard mounting pads are acceptable, but machine set up may need to be modified.

LEAD-FREE PROGRAM

AVX also offers 100% Tin termination finish on its TAJ, TPS, THJ, NOJ and NOS series surface mount Tantalum capacitors. After that date all products are available with lead-free terminations per requests. Refer the the first page of each series for order.

TAC standard termination is barrier nickel overlaid with pure tin (Lead-Free).

A barrier nickel and gold termination suitable for conductive epoxy is available. Other gold finishes are available upon request.

The 100% Tin termination is compatible with and all common lead free pastes; SnCu, SnAgCu, SnCuAgBi, etc.

It is also compatible with existing SnPb solder pastes / systems in use today.

The recommended IR reflow profile is shown below.

IR REFLOW - SnPb

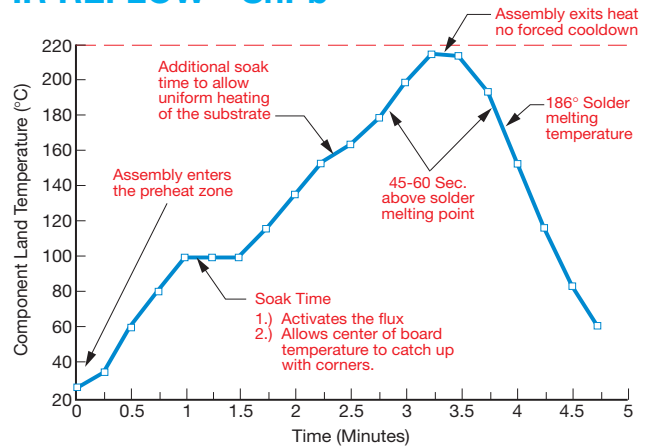

Recommended Ramp Rate Less than 2°C/sec.

LEAD-FREE WAVE SOLDERING

The recommended peak temperature for lead-free wave soldering is 250°C-260°C for 3-5 seconds. The other parameters of the profile remains the same as above.

MOISTURE SENSITIVITY LEVELS (according to J-STD-020C)

Level 1 for TAJ, TPS, THJ, TRJ, TPM, TAC, TPC, TMC, NOJ*, NOS*, NOM*

Level 3 for TLJ, TCJ, TLC, NOJ**, NOS**, NOM**, NPV

*Excluding case sizes D, E, X, Y, V

**Case sizes D, E, X, Y, V

Technical Summary and Application Guidelines



SECTION 5 MECHANICAL AND THERMAL PROPERTIES OF CAPACITORS

5.1 Acceleration

98.1m/s² (10g)

5.2 Vibration Severity

10 to 2000Hz, 0.75mm of 98.1m/s² (10g)

5.3 Shock

Trapezoidal Pulse, 98.1m/s² for 6ms.

5.4 Adhesion to Substrate

IEC 384-3. minimum of 5N.

5.5 Resistance to Substrate Bending

The component has compliant leads which reduces the risk of stress on the capacitor due to substrate bending.

5.6 Soldering Conditions

Dip soldering is permissible provided the solder bath temperature is $\leq 270^{\circ}\text{C}$, the solder time < 3 seconds and the circuit board thickness $\geq 1.0\text{mm}$.

5.7 Installation Instructions

The upper temperature limit (maximum capacitor surface temperature) must not be exceeded even under the most unfavorable conditions when the capacitor is installed. This must be considered particularly when it is positioned near components which radiate heat strongly (e.g. valves and power transistors). Furthermore, care must be taken, when bending the wires, that the bending forces do not strain the capacitor housing.

5.8 Installation Position

No restriction.

5.9 Soldering Instructions

Fluxes containing acids must not be used.

5.9.1 Guidelines for Surface Mount Footprints

Component footprint and reflow pad design for AVX capacitors.

The component footprint is defined as the maximum board area taken up by the terminators. The footprint dimensions are given by A, B, C and D in the diagram, which corresponds to W, max., A max., S min. and L max. for the component. The footprint is symmetric about the center lines.

The dimensions x, y and z should be kept to a minimum to reduce rotational tendencies while allowing for visual inspection of the component and its solder fillet.

Dimensions PS (Pad Separation) and PW (Pad Width) are calculated using dimensions x and z. Dimension y may vary, depending on whether reflow or wave soldering is to be performed.

For reflow soldering, dimensions PL (Pad Length), PW (Pad Width), and PSL (Pad Set Length) have been calculated. For wave soldering the pad width (PWw) is reduced to less than the termination width to minimize the amount of solder pick up while ensuring that a good joint can be produced.

NOTE: These recommendations (also in compliance with EIA) are guidelines only. With care and control, smaller footprints may be considered for reflow soldering.

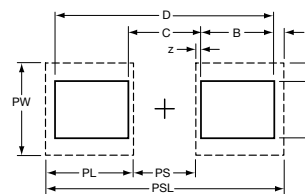

Nominal footprint and pad dimensions for each case size are given in the following tables:

PAD DIMENSIONS: millimeters (inches)

Case Size	PSL	PL	PS	PW	PWw	
TAJ TPS TRJ THJ TLJ TCJ TPM NOJ NOS NOM & CWR11	A	4.00 (0.157)	1.40 (0.054)	1.20 (0.047)	1.80 (0.071)	0.90 (0.035)
	B	4.00 (0.157)	1.40 (0.054)	1.20 (0.047)	2.80 (0.110)	1.60 (0.063)
	C	6.50 (0.256)	2.00 (0.079)	2.50 (0.098)	2.80 (0.110)	1.60 (0.063)
	D	8.00 (0.315)	2.00 (0.079)	4.00 (0.157)	3.00 (0.119)	1.70 (0.068)
	E	8.00 (0.315)	2.00 (0.079)	4.00 (0.157)	3.00 (0.119)	1.70 (0.068)
	F	6.50 (0.256)	2.00 (0.079)	2.50 (0.098)	2.80 (0.110)	1.60 (0.063)
	G	4.00 (0.157)	1.40 (0.054)	1.20 (0.047)	1.80 (0.071)	0.90 (0.035)
	H	4.00 (0.157)	1.40 (0.054)	1.20 (0.047)	2.80 (0.110)	1.60 (0.063)
	J	2.80 (0.110)	1.10 (0.043)	0.60 (0.024)	1.00 (0.039)	-
	K	4.00 (0.157)	1.40 (0.054)	1.20 (0.047)	1.80 (0.071)	0.90 (0.035)
TAC TPC R/H/U	N	2.70 (0.100)	0.95 (0.037)	0.80 (0.030)	1.60 (0.060)	0.80 (0.030)
	P	2.70 (0.100)	0.95 (0.037)	0.80 (0.030)	1.60 (0.060)	0.80 (0.030)
	R	2.70 (0.100)	0.95 (0.037)	0.80 (0.030)	1.60 (0.060)	0.80 (0.030)
	S	4.00 (0.157)	1.40 (0.054)	1.20 (0.047)	1.80 (0.071)	0.90 (0.035)
	T	4.00 (0.157)	1.40 (0.054)	1.20 (0.047)	2.80 (0.110)	1.60 (0.063)
	V	8.00 (0.315)	2.00 (0.079)	4.00 (0.157)	3.70 (0.145)	1.70 (0.068)
	W	6.50 (0.256)	2.00 (0.079)	2.50 (0.098)	2.80 (0.110)	1.60 (0.063)
	X	8.00 (0.315)	2.00 (0.079)	4.00 (0.157)	3.00 (0.119)	1.70 (0.068)
	Y	8.00 (0.315)	2.00 (0.079)	4.00 (0.157)	3.00 (0.119)	1.70 (0.068)
	Z	8.00 (0.315)	2.00 (0.079)	4.00 (0.157)	3.00 (0.119)	1.70 (0.068)
TAC TPC R/H/U	L	2.80 (0.110)	1.10 (0.043)	0.60 (0.024)	1.00 (0.039)	-
	M	3.20 (0.126)	1.30 (0.051)	0.60 (0.024)	1.50 (0.059)	-
	X	4.20 (0.165)	1.60 (0.063)	1.00 (0.039)	1.60 (0.063)	-
	A	4.40 (0.173)	1.60 (0.063)	1.20 (0.047)	1.80 (0.071)	-
	T	4.70 (0.185)	1.70 (0.070)	1.30 (0.051)	3.00 (0.118)	-

5.10 PCB Cleaning

Ta chip capacitors are compatible with most PCB board cleaning systems.

If aqueous cleaning is performed, parts must be allowed to dry prior to test. In the event ultrasonics are used power levels should be less than 10 watts per/litre, and care must be taken to avoid vibrational nodes in the cleaning bath.

SECTION 6 EPOXY FLAMMABILITY

EPOXY	UL RATING	OXYGEN INDEX
TAJ/TPS/TRJ/THJ/ TPM/CWR11	UL94 V-0	35%

SECTION 7 QUALIFICATION APPROVAL STATUS

DESCRIPTION	STYLE	SPECIFICATION
Surface mount capacitors	TAJ	CECC 30801 - 005 Issue 2 CECC 30801 - 011 Issue 1 MIL-C-55365/8 (CWR11)
	TAZ	MIL-C-55365/4 (CWR09)