

Distributed by:

**JAMECO**<sup>®</sup>  
ELECTRONICS

**www.Jameco.com ♦ 1-800-831-4242**

The content and copyrights of the attached  
material are the property of its owner.

Jameco Part Number 1943334



■ Features :

- Universal AC input/Full range
- Protections: Short circuit / Overload / Over voltage
- Cooling by free air convection
- Can be installed on DIN rail TS-35/7.5 or 15
- NEC class 2 / LPS compliant
- Built in DC OK active signal
- LED indicator for power on
- No load power consumption<0.75W
- 100% full load burn-in test
- 3 years warranty

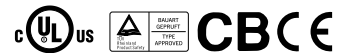

**SPECIFICATION**

MODEL	MDR-20-5	MDR-20-12	MDR-20-15	MDR-20-24	
OUTPUT	DC VOLTAGE	5V	12V	15V	24V
	RATED CURRENT	3A	1.67A	1.34A	1A
	CURRENT RANGE	0 ~ 3A	0 ~ 1.67A	0 ~ 1.34A	0 ~ 1A
	RATED POWER	15W	20W	20W	24W
	RIPPLE & NOISE (max.) Note.2	80mVp-p	120mVp-p	120mVp-p	150mVp-p
	VOLTAGE ADJ. RANGE	4.75 ~ 5.5V	10.8 ~ 13.2V	13.5 ~ 16.5V	21.6 ~ 26.4V
	VOLTAGE TOLERANCE Note.3	±2.0%	±1.0%	±1.0%	±1.0%
	LINE REGULATION	±1.0%	±1.0%	±1.0%	±1.0%
	LOAD REGULATION	±1.0%	±1.0%	±1.0%	±1.0%
	SETUP, RISE TIME Note.5	500ms, 30ms/230VAC	1000ms, 30ms/115VAC at full load		
HOLD UP TIME (Typ.)	50ms/230VAC	20ms/115VAC at full load			
INPUT	VOLTAGE RANGE	85 ~ 264VAC	120 ~ 370VDC		
	FREQUENCY RANGE	47 ~ 63Hz			
	EFFICIENCY (Typ.)	76%	80%	81%	84%
	AC CURRENT (Typ.)	0.55A/115VAC	0.35A/230VAC		
	INRUSH CURRENT (Typ.)	COLD START 20A/115VAC	40A/230VAC		
	LEAKAGE CURRENT	<1mA / 240VAC			
PROTECTION	OVERLOAD	105 ~ 160% rated output power Protection type : Constant current limiting, recovers automatically after fault condition is removed			
	OVER VOLTAGE	5.75 ~ 6.75V	13.8 ~ 16.2V	17.25 ~ 20.25V	27.6 ~ 32.4V
		Protection type : Shut down o/p voltage, re-power on to recover			
FUNCTION	DC OK ACTIVE SIGNAL (max.)	3.75 ~ 6V / 50mA	9 ~ 13.5V / 40mA	11.5 ~ 16.5V / 40mA	18 ~ 27V / 20mA
ENVIRONMENT	WORKING TEMP.	-20 ~ +70°C (Refer to output load derating curve)			
	WORKING HUMIDITY	20 ~ 90% RH non-condensing			
	STORAGE TEMP., HUMIDITY	-40 ~ +85°C, 10 ~ 95% RH			
	TEMP. COEFFICIENT	±0.03%/°C (0 ~ 50°C)			
	VIBRATION	Component:10 ~ 500Hz, 2G 10min./1cycle, 60min. each along X, Y, Z axes; Mounting: Compliance to IEC60068-2-6			
SAFETY & EMC (Note 4)	SAFETY STANDARDS	UL508, TUV EN60950-1 approved, NEC class 2 / LPS compliant			
	WITHSTAND VOLTAGE	I/P-O/P:3KVAC I/P-FG:1.5KVAC O/P-FG:0.5KVAC			
	ISOLATION RESISTANCE	I/P-O/P, I/P-FG, O/P-FG:100M Ohms/500VDC			
	EMI CONDUCTION & RADIATION	Compliance to EN55011,EN55022 (CISPR22), EN61204-3 Class B			
	HARMONIC CURRENT	Compliance to EN61000-3-2,-3			
	EMS IMMUNITY	Compliance to EN61000-4-2, 3, 4, 5, 6, 8, 11, ENV50204, EN55024,EN61000-6-1,EN61204-3, light industry level, criteria A			
OTHERS	MTBF	236.9K hrs min. MIL-HDBK-217F (25°C)			
	DIMENSION	22.5*90*100mm (W*H*D)			
	PACKING	0.19Kg; 72pcs/14.7Kg/0.91CUFT			
NOTE	<ol style="list-style-type: none"> <li>1. All parameters NOT specially mentioned are measured at 230VAC input, rated load and 25°C of ambient temperature.</li> <li>2. Ripple &amp; noise are measured at 20MHz of bandwidth by using a 12" twisted pair-wire terminated with a 0.1uf &amp; 47uf parallel capacitor.</li> <li>3. Tolerance : includes set up tolerance, line regulation and load regulation.</li> <li>4. The power supply is considered a component which will be installed into a final equipment. The final equipment must be re-confirmed that it still meets EMC directives.</li> <li>5. Length of set up time is measured at cold first start. Turning ON/OFF the power supply may lead to increase of the set up time.</li> </ol>				

**Mechanical Specification**

Case No. 956 Unit:mm

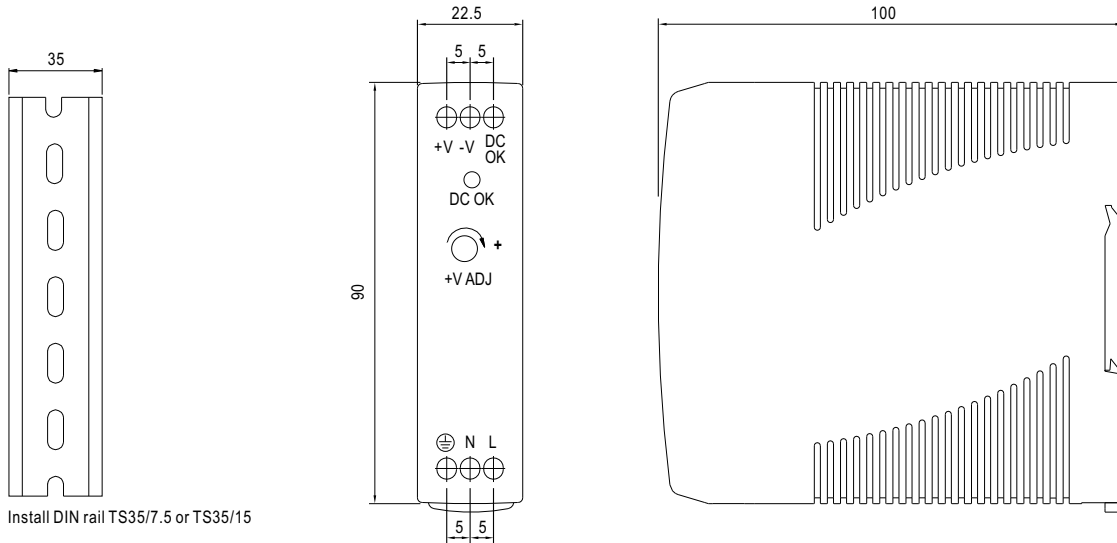

**Block Diagram**

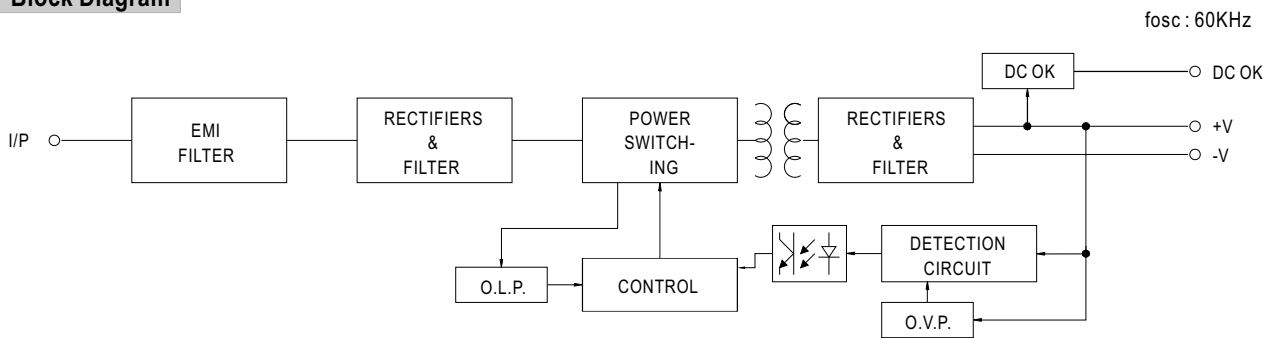

**Application of DC OK Active Signal**

(a) 5V signal

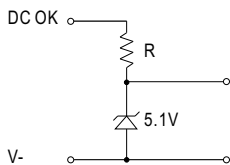

Model	R
5V	≥ 200Ω
12V	≥ 1.5KΩ
15V	≥ 2KΩ
24V	≥ 3.9KΩ

(b) LED

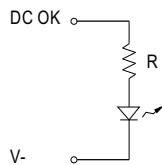

Model	R
5V	≥ 1KΩ
12V	≥ 2.4KΩ
15V	≥ 3KΩ
24V	≥ 4.7KΩ

(c) Relay

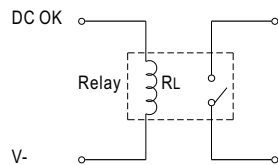

Model	RL
5V	≥ 120Ω
12V	≥ 700Ω
15V	≥ 700Ω
24V	≥ 1.2KΩ

**Derating Curve**

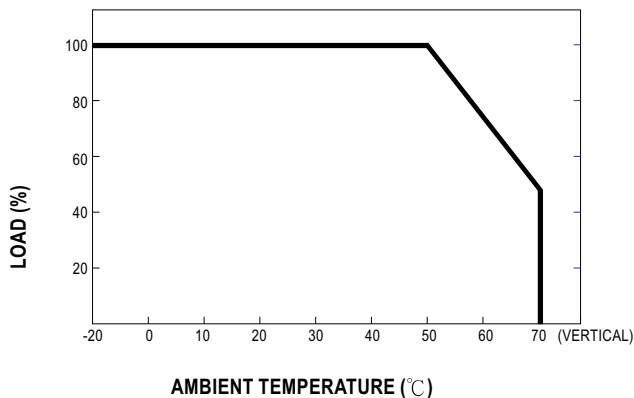

**Output Derating VS Input Voltage**

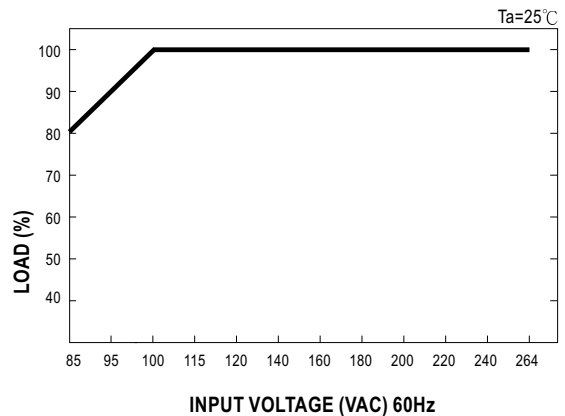

MODEL : MDR-20-12

OUTPUT FUNCTION TEST

NO	TEST ITEM	SPECICATION	TEST CONDITION	RESULT	VERDICT
1	RIPPLE & NOISE	V1: 120 mVp-p (Max)	I/P: 230VAC O/P:FULL LOAD Ta:25°C	V1: 19 mVp-p (Max)	p
2	OUTPUT VOLTAGE ADJUST RANGE	CH1: 10.8 V- 13.2 V	I/P: 230 VAC I/P: 115 VAC O/P:MIN LOAD Ta:25°C	10.21 V- 13.85 V/ 230 VAC 10.21 V- 13.85 V/ 115 VAC	p
3	OUTPUT VOLTAGE TOLERANCE	V1: 1 %- -1 % (Max)	I/P: 100 VAC / 264 VAC O/P:FULL/ MIN LOAD Ta:25°C	V1: 0.2 %- -0.2 %	p
4	LINE REGULATION	V1: 1 %- -1 % (Max)	I/P: 100 VAC ~ 264 VAC O/P:FULL LOAD Ta:25°C	V1: 0 %- 0 %	p
5	LOAD REGULATION	V1: 1 %- -1 % (Max)	I/P: 230 VAC O/P:FULL ~MIN LOAD Ta:25°C	V1: 0.15 %- -0.15 %	p
6	SET UP TIME	230VAC: 500 ms (Max) 115 VAC: 1000 ms (Max)	I/P: 230 VAC I/P: 115 VAC O/P:FULL LOAD Ta:25°C	230VAC/ 241 ms 115VAC/ 275 ms	p
7	RISE TIME	230VAC: 30 ms (Max) 115VAC: 30 ms (Max)	I/P: 230 VAC I/P: 115 VAC O/P:FULL LOAD Ta:25°C	230VAC/ 7 ms 115VAC/ 6 ms	p
8	HOLD UP TIME	230VAC: 50 ms (TYP) 115VAC: 20 ms (TYP)	I/P: 230 VAC I/P: 115 VAC O/P:FULL LOAD Ta:25°C	230VAC/ 133 ms 115VAC/ 29 ms	p
9	OVER/UNDERSHOOT TEST	< ±5%	I/P: 230 VAC O/P:FULL LOAD Ta:25°C	TEST: <5 %	p
10	DYNAMIC LOAD	V1: 1200 mVp-p	I/P: 230 VAC O/P:FULL /Min LOAD 90%DUTY/1KHZ Ta:25°C	312 mVp-p	p

**INPUT FUNCTION TEST**

NO	TEST ITEM	SPECICATION	TEST CONDITION	RESULT	VERDICT
1	INPUT VOLTAGE RANGE	85VAC~264 VAC	I/P:TESTING O/P:FULL LOAD Ta:25°C	46V~264V	p
			I/P: LOW-LINE-3V= 82 V HIGH-LINE+15%=300 V O/P:FULL/MIN LOAD ON: 30 Sec . OFF: 30 Sec 10MIN ( AC POWER ON/OFF NO DAMAGE )	TEST: OK	
2	INPUT FREQUENCY RANGE	47HZ ~63 HZ NO DAMAGE OSC	I/P: 85 VAC ~ 264 VAC O/P:FULL~MIN LOAD Ta:25°C	TEST: OK	p
3	EFFICIENCY	80 % (TYP)	I/P: 230 VAC O/P:FULL LOAD Ta:25°C	81.2%	p
4	INPUT CURRENT	230V/ 0.35 A (TYP) 115V/ 0.55 A (TYP)	I/P: 230 VAC I/P: 115 VAC O/P:FULL LOAD Ta:25°C	I = 0.25 A/ 230 VAC I = 0.38 A/ 115 VAC	p
5	INRUSH CURRENT	230V/ 40 A (TYP) 115V/ 20 A (TYP) COLD START	I/P: 230 VAC I/P: 115 VAC O/P:FULL LOAD Ta:25°C	I = 22 A/ 230 VAC I = 11 A/ 115 VAC	p
6	LEAKAGE CURRENT	< 1 mA / 240 VAC	I/P: 254 VAC O/P:Min LOAD Ta:25°C	L-FG: 0.64 mA N-FG: 0.64 mA	p

**PROTECTION FUNCTION TEST**

NO	TEST ITEM	SPECICATION	TEST CONDITION	RESULT	VERDICT
1	OVER LOAD PROTECTION	105 %~ 160 %	I/P: 230 VAC I/P: 115 VAC O/P:TESTING Ta:25°C	128 %/ 230 VAC 127 %/ 115 VAC Constant Current Limiting	p
2	OVER VOLTAGE PROTECTION	CH1: 13.8 V~ 16.2 V	I/P: 230 VAC I/P: 115 VAC O/P:MIN LOAD Ta:25°C	15.3 V/ 230 VAC 15.3 V/ 115 VAC Shunt down Re- power ON	p
3	SHORT PROTECTION	SHORT EVERY OUTPUT 1 HOUR NO DAMAGE	I/P: 264 VAC O/P:FULL LOAD Ta:25°C	NO DAMAGE Constant Current Limiting	p

**CONTROL FUNCTION TEST**

NO	TEST ITEM	SPECICATION	TEST CONDITION	RESULT	VERDICT
1	NO LOAD POWER CON SUMPTION	<0.75W	I/P: 230 VAC I/P: 115 VAC O/P:NO LOAD Ta:25°C	230 VAC/ 0.71W 115 VAC/ 0.62W	p
2	DC OK ACTIVE SIGNAL (max)	9V~13.5V / 40mA	I/P: 230 VAC I/P: 115 VAC O/P: 40mA Ta:25°C	230 VAC/ 11.93V 115 VAC/ 11.97V	p

ENVIRONMENT TEST

NO	TEST ITEM	SPECIFICATION	TEST CONDITION	RESULT	VERDICT
1	TEMPERATURE RISE TEST	MODEL : MDR-20-24 1. ROOM AMBIENT BURN-IN : 1.5HRS I/P: 230VAC O/P: FULL LOAD Ta= 31.4℃ 2. HIGH AMBIENT BURN-IN : 45HRS I/P: 230VAC O/P: FULL LOAD Ta= 44.6℃			p
2	OVER LOAD BURN-IN TEST	NO DAMAGE 1 HOUR ( MIN )	I/P: 230 VAC O/P: 132% LOAD Ta:25℃	TEST : OK	p
3	LOW TEMPERATURE TURN ON TEST	TURN ON AFTER 2 HOUR	I/P: 230 VAC O/P: 100% LOAD Ta= -20℃	TEST : OK	p
4	HIGH HUMIDITY HIGH TEMPERATURE HIGH VOLTAGE TURN ON TEST	AFTER 12 HOURS IN CHAMBER ON CONTROL 50℃ NO DAMAGE	I/P: 272 VAC O/P:FULL LOAD Ta= 50℃ HUMIDITY= 95 %R.H	TEST : OK	p
5	TEMPERATURE COEFFICIENT	± 0.03 %(0-50℃)	I/P: 230 VAC O/P:FULL LOAD	± 0.004 %(0-50℃)	p
6	VIBRATION TEST	1 Carton & 1 Set (1) Waveform: Sine Wave (2) Frequency:10-500Hz (3) Sweep Time:10min/sweep cycle (4) Acceleration:2G (5) Test Time:1 hour in each axis (X.Y.Z) (6) Ta:25℃		TEST : OK	p

**SAFETY TEST**

NO	TEST ITEM	SPECIFICATION	TEST CONDITION	RESULT	VERDICT
1	WITHSTAND VOLTAGE	I/P-O/P: 3 KVAC/min I/P-FG: 1.5 KVAC/min O/P-FG: 0.5 KVAC/min	I/P-O/P: 3.6 KVAC/min I/P-FG: 1.8 KVAC/min O/P-FG: 0.6 KVAC/min Ta:25°C	I/P-O/P: 3.9 mA I/P-FG: 4.46 mA O/P-FG: 2.08 mA NO DAMAGE	p
2	ISOLATION RESISTANCE	I/P-O/P:500VDC>100MΩ I/P-FG: 500VDC>100MΩ O/P-FG:500VDC>100MΩ	I/P-O/P: 500 VDC I/P-FG: 500 VDC O/P-FG: 500 VDC Ta:25°C	I/P-O/P: 18 GΩ I/P-FG: 9 GΩ O/P-FG: 30 GΩ NO DAMAGE	p
3	GROUNDING CONTINUITY	FG(PE) TO CHASSIS OR TRACE < 100 mΩ	40 A / 2min Ta:25°C	13 mΩ	p
4	APPROVAL	TUV: Certificate NO : R50093954 UL: File NO : E215312			p

**E.M.C TEST**

NO	TEST ITEM	SPECIFICATION	TEST CONDITION	RESULT	VERDICT
1	HARMONIC	EN61000-3-2 CLASS A	I/P: 230 VAC/50HZ O/P:FULL LOAD Ta:25°C	PASS	p
2	CONDUCTION	EN55022 EN55011 CLASS B	I/P: 230 VAC (50HZ) O/P:FULL/50% LOAD Ta:25°C	PASS Test by certified Lab	p
3	RADIATION	EN55022 EN55011 CLASS B	I/P: 230 VAC (50HZ) O/P:FULL LOAD Ta:25°C	PASS Test by certified Lab	p
4	E.S.D	EN61000-4-2 LIGHT INDUSTRY AIR:8KV / Contact:4KV	I/P: 230 VAC/50HZ O/P:FULL LOAD Ta:25°C	CRITERIA A	p
5	E.F.T	EN61000-4-4 LIGHT INDUSTRY INPUT: 1KV	I/P: 230 VAC/50HZ O/P:FULL LOAD Ta:25°C	CRITERIA A	p
6	SURGE	IEC61000-4-5 LIGHT INDUSTRY L-N :1KV L,N-PE:2KV	I/P: 230 VAC/50HZ O/P:FULL LOAD Ta:25°C	CRITERIA A	p
7	Test by certified Lab & Test Report Prepare				

**M.T.B.F & LIFE CYCLE CALCULATION**

NO	TEST ITEM	SPECIFICATION	TEST CONDITION	RESULT	VERDICT
1	CAPACITOR LIFE CYCLE	MDR-20-24 : SUPPOSE C105 IS THE MOST CRITICAL COMPONENT I/P: 230VAC O/P:FULL LOAD Ta= 25°C LIFE TIME= 219673 HRS I/P: 230VAC O/P:FULL LOAD Ta= 50°C LIFE TIME= 45198 HRS			p
2	MTBF	MIL-HDBK-217F NOTICES2 PARTS COUNT TOTAL FAILURE RATE: 236.9KHRS			p

**COMPONENT STRESS TEST**

NO	TEST ITEM	SPECICATION	TEST CONDITION	RESULT	VERDICT
1	Power Transistor ( D to S) or (C to E) <b>Peak Voltage</b>	Q1 Rated K3562 : 600V / 6 A	I/P:High-Line +3V = 267 V O/P: (1)Full Load Turn on (2) Output Short Ta:25°C	(1) 574 V (2) 580 V	p
2	Diode Peak <b>Voltage</b>	D100 Rated BYQ28X-200 : 200V/ 10 A	I/P:High-Line +3V = 267 V O/P: (1)Full Load Turn on (2)Output Short Ta:25°C	(1) 129 V (2) 108 VV	p
3	Clamp Diode Peak <b>Voltage</b>	D1 Rated EGP20J : 600V/ 2A	I/P:High-Line +3V = 267 V O/P: (1) Dynamic Load 90%Duty/1KHz Ta:25°C	(1) 550 V	p
4	<b>Input Capacitor Voltage</b>	C5 Rated :33u / 400V/ 105°C	I/P:High-Line +3V = 267 V O/P: (1)Full Load Turn on /Off (2) Min load Turn on /Off (3)Full Load /Min load Change Ta:25°C	(1) 382 V (2) 386 V (3) 386 V	p
5	<b>Control IC Voltage Test</b>	U1 Rated NCP1200 : 16V	I/P:High-Line +3V = 267 V O/P: (1)Full Load Turn on /Off (2) Min load Turn on /Off (3)Full Load /Min load Change Ta:25°C	(1) 12.7 V (2) 11 V (3) 11 V	p

DATE	SAMPLE	TEST RESULT	TESTER	APPROVAL
2006/8/24	RD SAMPLE	PASS	VINCENT TSENG	MAX LIN
2006/10/3	PRODUCT SAMPLE W0609B03	PASS	VINCENT TSENG	MAX LIN
2006/11/15	PRODUCT SAMPLE W0611A07	PASS	VINCENT TSENG	MAX LIN
2007/1/11	PRODUCT SAMPLE W0612C10	PASS	VINCENT TSENG	MAX LIN

2003/12/12 A50-F023