

Distributed by:

JAMECO[®]
ELECTRONICS

www.Jameco.com ♦ 1-800-831-4242

The content and copyrights of the attached
material are the property of its owner.

Jameco Part Number 1973461

LOC	DIST	REVISIONS			
P	LR	DESCRIPTION	DATE	DWN	APPD
AJ	16	A	REVISED PER EC OS14-0150-05	30AUG05	BM JL

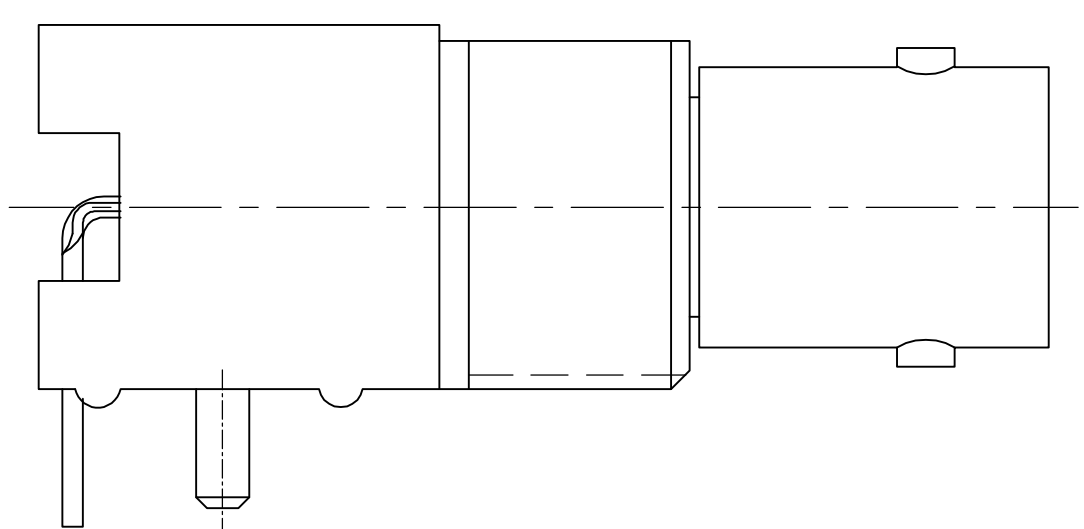
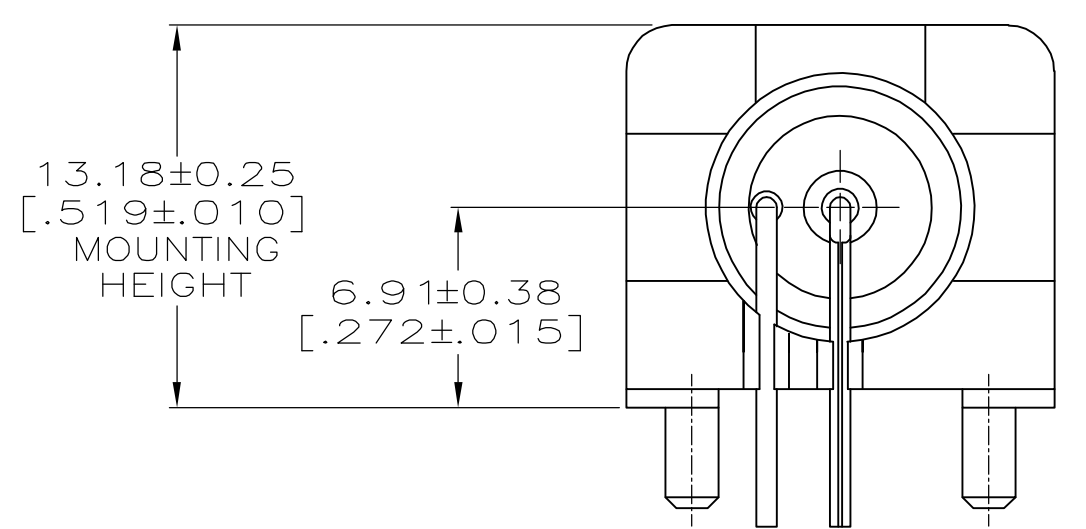

VIEW C
(SAME AS VIEW A EXCEPT AS SHOWN)

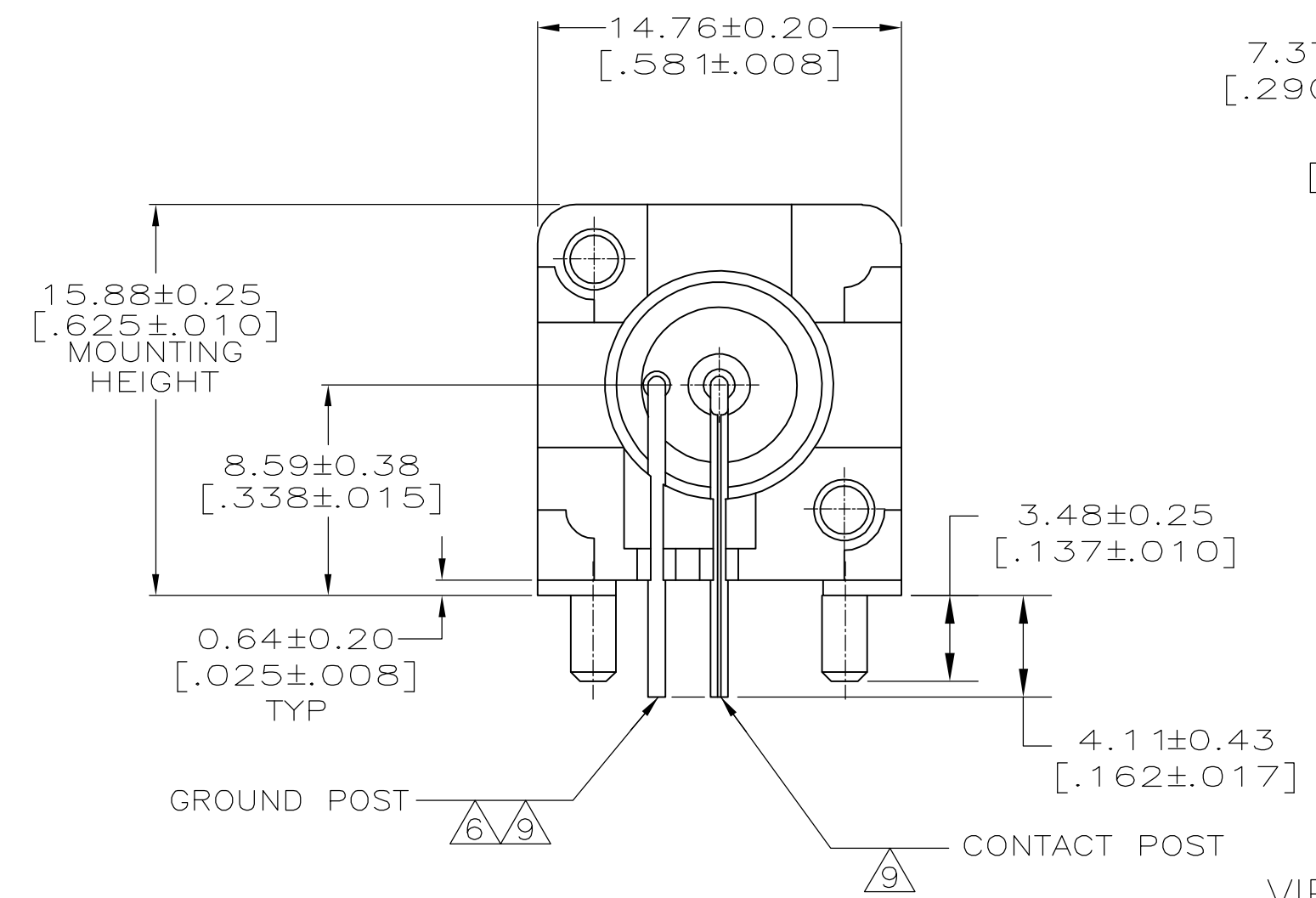

VIEW A

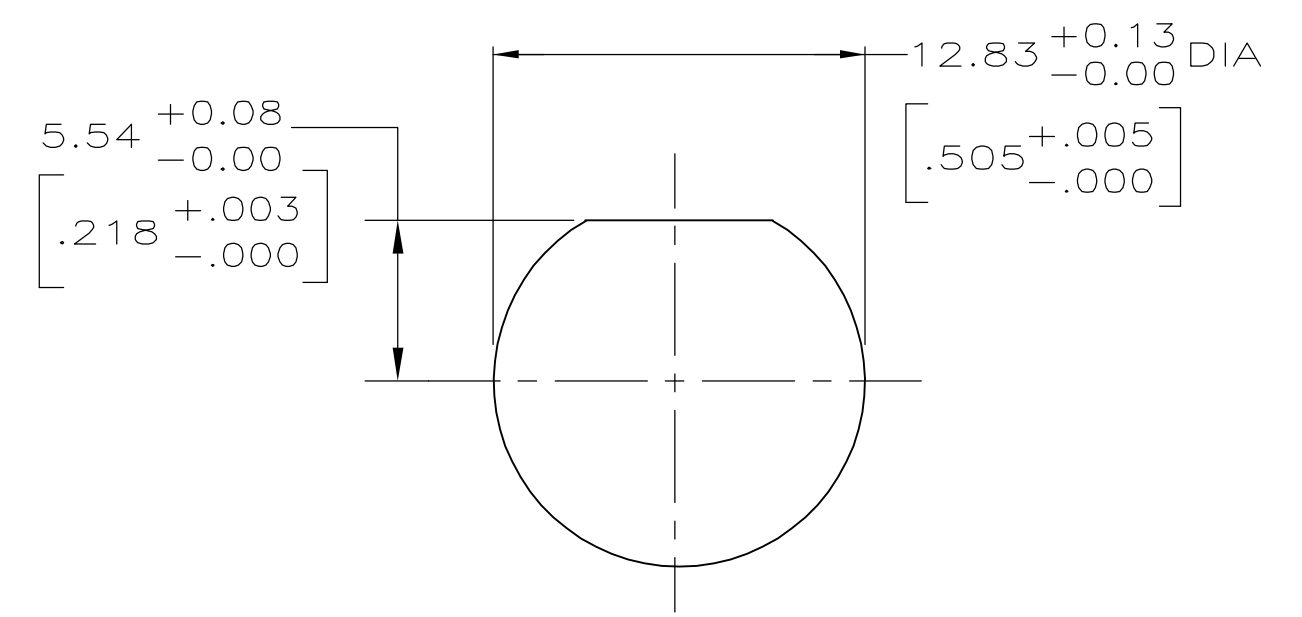
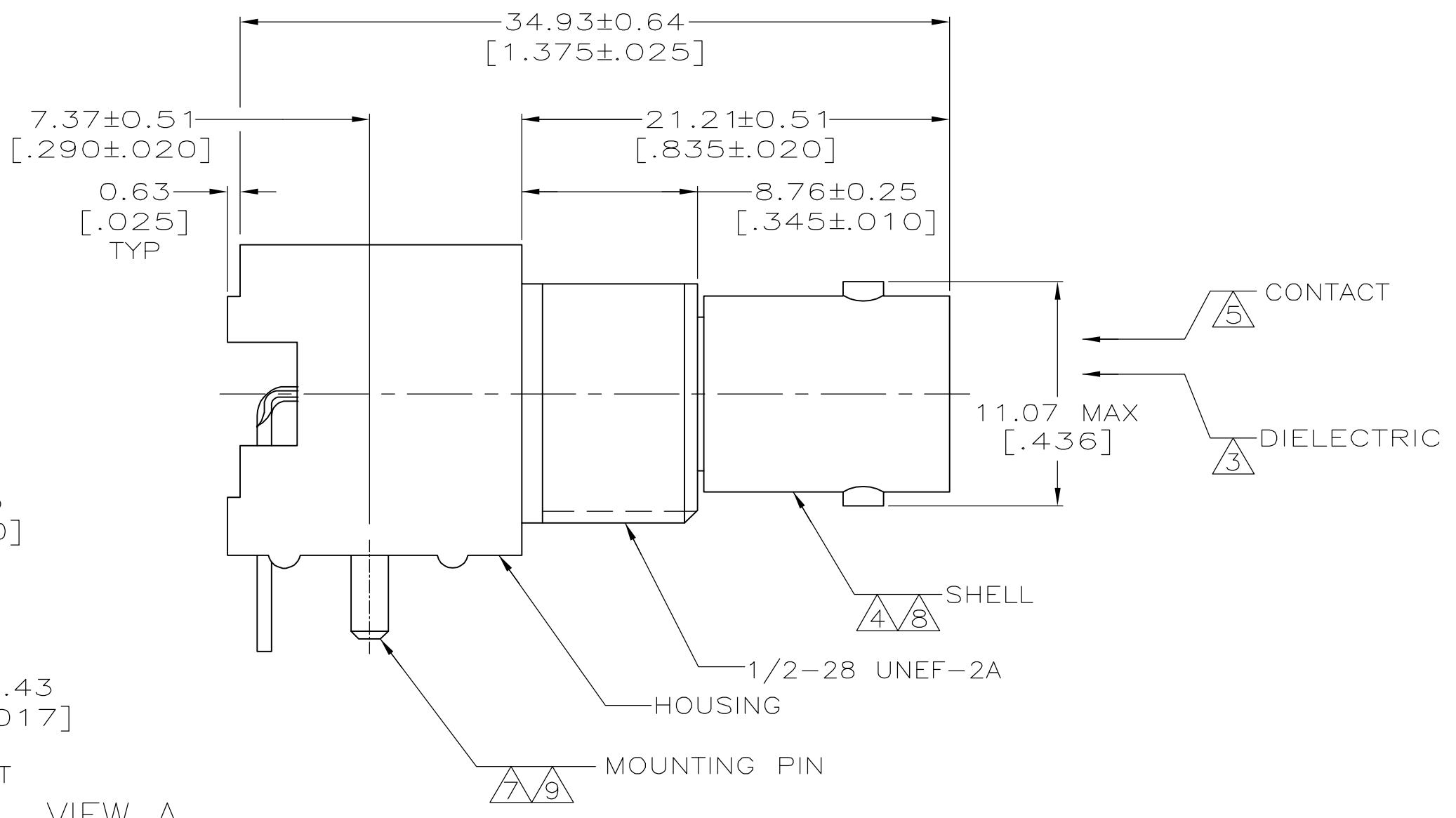

RECOMMENDED PANEL CUTOUT

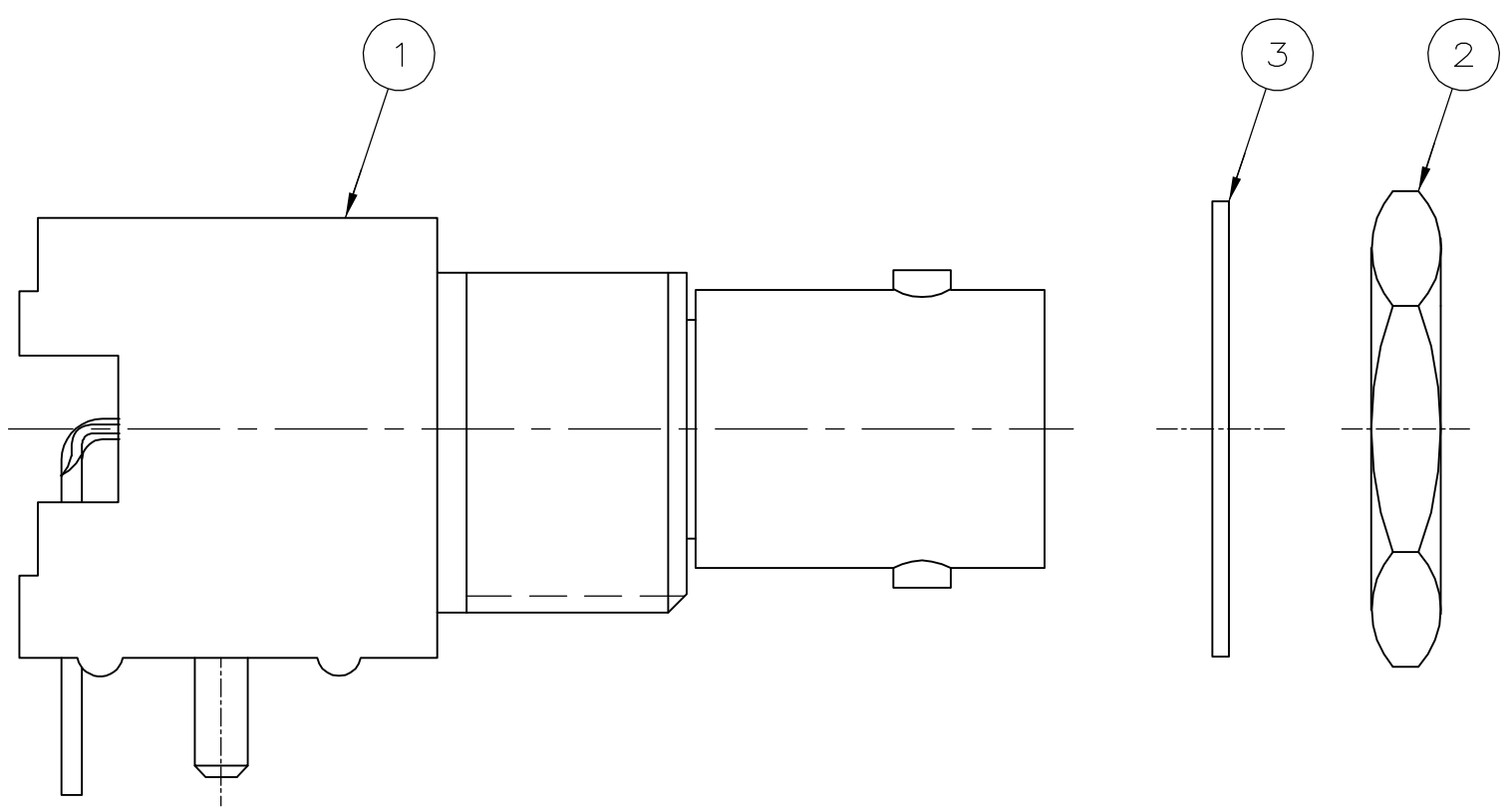

VIEW B

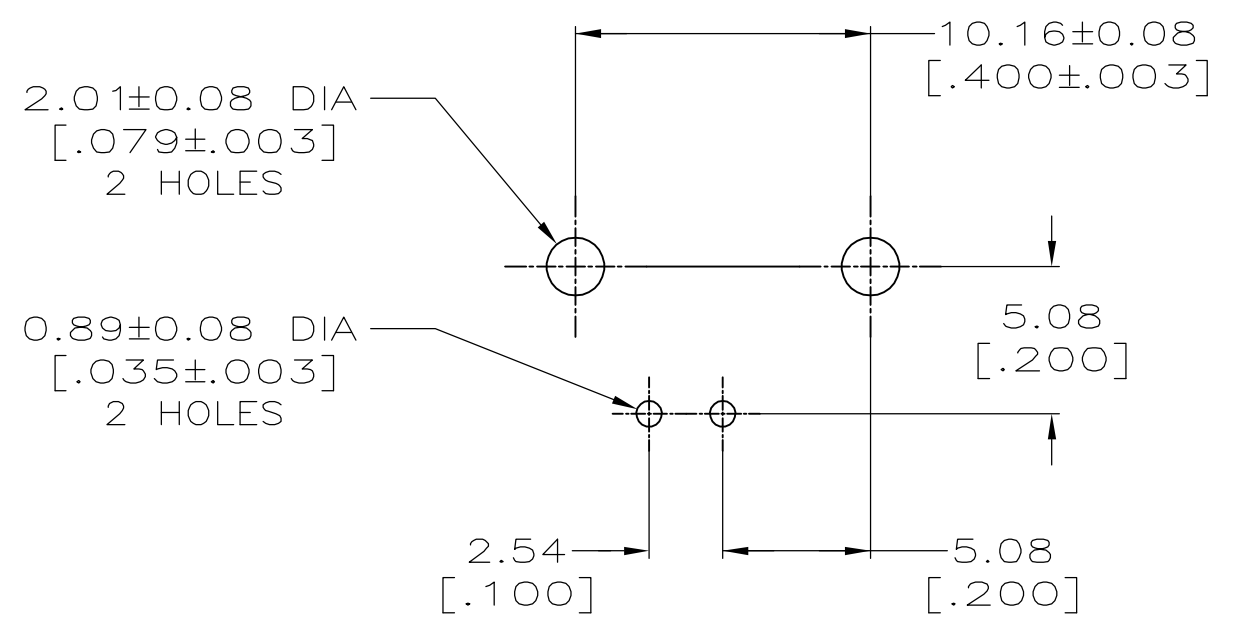

PCB CONFIGURATION

CONTACT FINISH	HOUSING MATERIAL	VIEW	LOCKWASHER	JAM NUT QTY=1	ASSEMBLY QTY=1	PART NUMBER
-	-	B	1-329632-2	1-329631-2	5227161-9	1-5227161-7
-	-	B	1-329632-2	1-329631-2	5227161-6	1-5227161-6
△	△	C	-	-	-	1-5227161-5
△	△	C	-	-	-	5227161-9
△	△	C	-	-	-	5227161-7
△	△	A	-	-	-	5227161-6
△	△	A	-	-	-	5227161-3
△	△	A	-	-	-	5227161-2
△	△	A	-	-	-	5227161-1

THIS DRAWING IS A CONTROLLED DOCUMENT.

DIMENSIONS: mm[INCHES]	TOLERANCES UNLESS OTHERWISE SPECIFIED:	0 PLC ± -	1 PLC ± -	2 PLC ± 0.05 [0.02]	3 PLC ± -	4 PLC ± -	ANGLES ± -	FINISH
		△△△△△△△△		△△△△△△△△				

DWN: L. VARELA - DOCK5
 CHK: J. HAVENER
 APVD: S. BURKHOLDER
 PRODUCT SPEC: 108-12078
 APPLICATION SPEC: -
 MATERIAL: -
 WEIGHT: -
 CUSTOMER DRAWING

Tyco Electronics Corporation
 Harrisburg, Pa 17105-3608
 JACK, RIGHT ANGLE, 50 OHM, PCB, BNC
 SIZE: A1
 CASE CODE: 00779
 DRAWING NO: C=5227161
 RESTRICTED TO: -
 SCALE: 4:1
 SHEET: 1 OF 1
 REV: A