

Distributed by:

JAMECO[®]
ELECTRONICS

www.Jameco.com ♦ 1-800-831-4242

The content and copyrights of the attached
material are the property of its owner.

Jameco Part Number 2021905

MC79M00 Series

500 mA Negative Voltage Regulators

The MC79M00 series of fixed output negative voltage regulators are intended as complements to the popular MC78M00 series devices.

Available in fixed output voltage options of -5.0 V , -8.0 V , -12 V and -15 V , these regulators employ current limiting, thermal shutdown, and safe-area compensation, making them remarkably rugged under most operating conditions. With adequate heatsinking they can deliver output currents in excess of 0.5 A .

- No External Components Required
- Internal Thermal Overload Protection
- Internal Short Circuit Current Limiting
- Output Transistor Safe-Area Compensation
- Also Available in Surface Mount DPAK (DT) Package
- Pb-Free Packages are Available

DEVICE TYPE/NOMINAL OUTPUT VOLTAGE

| Device | Nominal Output Voltage |
|---------|------------------------|
| MC79M05 | -5.0 V |
| MC79M08 | -8.0 V |
| MC79M12 | -12 V |
| MC79M15 | -15 V |

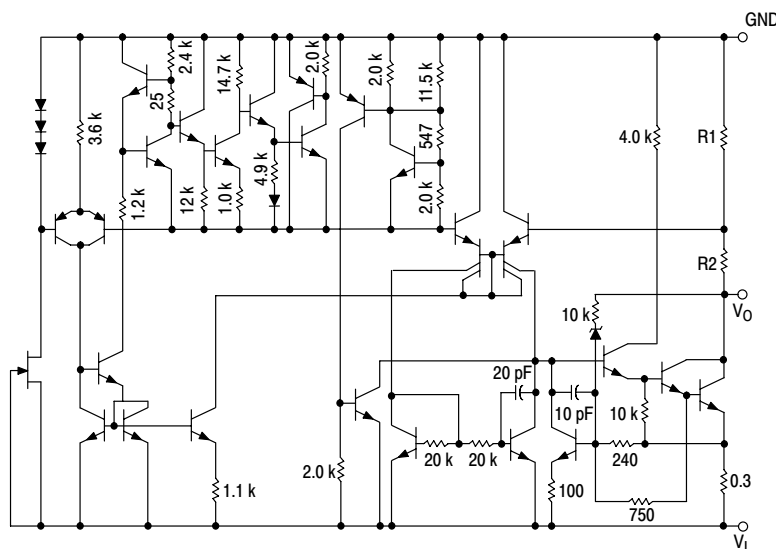

This device contains 31 active transistors.

Figure 1. Representative Schematic Diagram



ON Semiconductor®

<http://onsemi.com>

THREE-TERMINAL NEGATIVE FIXED VOLTAGE REGULATORS

STANDARD APPLICATION

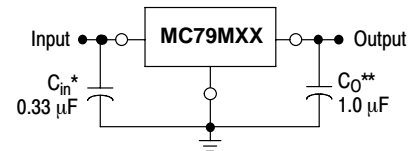

A common ground is required between the input and the output voltages. The input voltage must remain typically 1.1 V more negative even during the high point of the input ripple voltage.

XX These two digits of the type number indicate nominal voltage.

* C_{in} is required if regulator is located an appreciable distance from power supply filter.

** C_O improve stability and transient response.

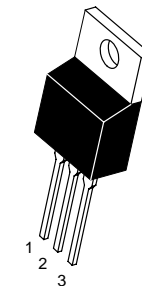

TO-220-3
T SUFFIX
CASE 221AB

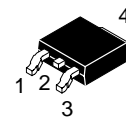

DPAK-3
DT SUFFIX
CASE 369C

MARKING DIAGRAMS

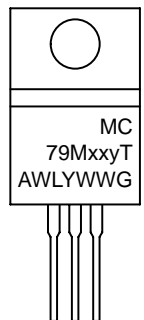

Pin 1. Ground
Pin 2. Input
Pin 3. Output

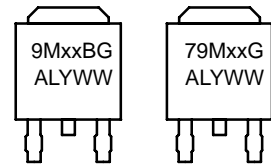

xx = 05, 08, 12, or 15
y = B or C
A = Assembly Location
WL, L = Wafer Lot
Y = Year
WW = Work Week
G = Pb-Free Device

ORDERING INFORMATION

See detailed ordering and shipping information in the package dimensions section on page 5 of this data sheet.

MC79M00 Series

MAXIMUM RATINGS ($T_A = 25^\circ\text{C}$, unless otherwise noted.)

| Rating | Symbol | Value | Unit |
|---|---------------|--------------------|--------------------|
| Input Voltage | V_I | -35 | Vdc |
| Power Dissipation | | | |
| Case 221A (TO-220-3) | | | |
| $T_A = 25^\circ\text{C}$ | P_D | Internally Limited | W |
| Thermal Resistance, Junction-to-Ambient | θ_{JA} | 65 | $^\circ\text{C/W}$ |
| Thermal Resistance, Junction-to-Case | θ_{JC} | 5.0 | $^\circ\text{C/W}$ |
| Case 369C (DPAK-3) | | | |
| $T_A = 25^\circ\text{C}$ | P_D | Internally Limited | W |
| Thermal Resistance, Junction-to-Ambient | θ_{JA} | 92 | $^\circ\text{C/W}$ |
| Thermal Resistance, Junction-to-Case | θ_{JC} | 6.0 | $^\circ\text{C/W}$ |
| Storage Junction Temperature | T_{stg} | -65 to +150 | $^\circ\text{C}$ |
| Operating Junction Temperature Range | T_J | -40 to +150 | $^\circ\text{C}$ |

Stresses exceeding Maximum Ratings may damage the device. Maximum Ratings are stress ratings only. Functional operation above the Recommended Operating Conditions is not implied. Extended exposure to stresses above the Recommended Operating Conditions may affect device reliability.

*This device series contains ESD protection and exceeds the following tests:

- Human Body Model 2000 V per MIL_STD_883, Method 3015
- Machine Model Method 200 V

MC79M05B, C

ELECTRICAL CHARACTERISTICS ($V_I = -10\text{ V}$, $I_O = 350\text{ mA}$, T_{low} to T_{high} (Note 2), unless otherwise noted.)

| Characteristic | Symbol | Min | Typ | Max | Unit |
|--|-------------------------|-------|------------|------------|----------------------------|
| Output Voltage ($T_J = 25^\circ\text{C}$) | V_O | -4.8 | -5.0 | -5.2 | Vdc |
| Line Regulation, $T_J = 25^\circ\text{C}$ (Note 1) -7.0 Vdc $\geq V_I \geq$ -25 Vdc -8.0 Vdc $\geq V_I \geq$ -18 Vdc | Reg_{line} | - | 7.0 2.0 | 50 30 | mV |
| Load Regulation, $T_J = 25^\circ\text{C}$ (Note 1) $5.0\text{ mA} \leq I_O \leq 500\text{ mA}$ | Reg_{load} | - | 30 | 100 | mV |
| Output Voltage -7.0 Vdc $\geq V_I \geq$ -25 Vdc, $5.0\text{ mA} \leq I_O \leq 350\text{ mA}$ | V_O | -4.75 | - | -5.25 | Vdc |
| Input Bias Current ($T_J = 25^\circ\text{C}$) | I_{IB} | - | 4.3 | 8.0 | mA |
| Input Bias Current Change -8.0 Vdc $\geq V_I \geq$ -25 Vdc, $I_O = 350\text{ mA}$ $5.0\text{ mA} \leq I_O \leq 350\text{ mA}$, $V_I = -10\text{ V}$ | ΔI_{IB} | - | - | 0.4 0.4 | mA |
| Output Noise Voltage, $T_A = 25^\circ\text{C}$, $10\text{ Hz} \leq f \leq 100\text{ kHz}$ | V_n | - | 40 | - | μV |
| Ripple Rejection ($f = 120\text{ Hz}$) | RR | 54 | 66 | - | dB |
| Dropout Voltage $I_O = 500\text{ mA}$, $T_J = 25^\circ\text{C}$ | $V_I - V_O$ | - | 1.1 | - | Vdc |
| Average Temperature Coefficient of Output Voltage $I_O = 5.0\text{ mA}$, $0^\circ\text{C} \leq T_J \leq 125^\circ\text{C}$ | $\Delta V_O / \Delta T$ | - | 0.2 | - | $\text{mV}/^\circ\text{C}$ |

1. Load and line regulation are specified at constant temperature. Change in V_O due to heating effects must be taken into account separately. Pulse testing with low duty cycle is used.
2. B = T_{low} to T_{high} , $-40^\circ\text{C} < T_J < 125^\circ\text{C}$ C = T_{low} to T_{high} , $0^\circ\text{C} < T_J < 125^\circ\text{C}$.

MC79M00 Series

MC79M08B, C

ELECTRICAL CHARACTERISTICS ($V_I = -10\text{ V}$, $I_O = 350\text{ mA}$, T_{low} to T_{high} (Note 4), unless otherwise noted.)

| Characteristic | Symbol | Min | Typ | Max | Unit |
|--|-------------------------|------|------------|------------|----------------------------|
| Output Voltage ($T_J = 25^\circ\text{C}$) | V_O | -7.7 | -8.0 | -8.3 | Vdc |
| Line Regulation, $T_J = 25^\circ\text{C}$ (Note 3) -7.0 Vdc $\geq V_I \geq$ -25 Vdc -8.0 Vdc $\geq V_I \geq$ -18 Vdc | Reg_{line} | - | 5.0 3.0 | 80 50 | mV |
| Load Regulation, $T_J = 25^\circ\text{C}$ (Note 3) $5.0\text{ mA} \leq I_O \leq 500\text{ mA}$ | Reg_{load} | - | 30 | 100 | mV |
| Output Voltage -7.0 Vdc $\geq V_I \geq$ -25 Vdc, $5.0\text{ mA} \leq I_O \leq 350\text{ mA}$ | V_O | -7.6 | -8.0 | -8.4 | Vdc |
| Input Bias Current ($T_J = 25^\circ\text{C}$) | I_{IB} | - | - | 8.0 | mA |
| Input Bias Current Change -8.0 Vdc $\geq V_I \geq$ -25 Vdc, $I_O = 350\text{ mA}$ $5.0\text{ mA} \leq I_O \leq 350\text{ mA}$, $V_I = -10\text{ V}$ | ΔI_{IB} | - | - | 0.4 0.4 | mA |
| Output Noise Voltage, $T_A = 25^\circ\text{C}$, $10\text{ Hz} \leq f \leq 100\text{ kHz}$ | V_n | - | 60 | - | μV |
| Ripple Rejection ($f = 120\text{ Hz}$) | RR | 54 | 63 | - | dB |
| Dropout Voltage $I_O = 500\text{ mA}$, $T_J = 25^\circ\text{C}$ | $V_I - V_O$ | - | 1.1 | - | Vdc |
| Average Temperature Coefficient of Output Voltage $I_O = 5.0\text{ mA}$, $0^\circ\text{C} \leq T_J \leq 125^\circ\text{C}$ | $\Delta V_O / \Delta T$ | - | 0.4 | - | $\text{mV}/^\circ\text{C}$ |

3. Load and line regulation are specified at constant temperature. Change in V_O due to heating effects must be taken into account separately. Pulse testing with low duty cycle is used.
4. B = T_{low} to T_{high} , $-40^\circ\text{C} < T_J < 125^\circ\text{C}$
C = T_{low} to T_{high} , $0^\circ\text{C} < T_J < 125^\circ\text{C}$

MC79M12B, C

ELECTRICAL CHARACTERISTICS ($V_I = -19\text{ V}$, $I_O = 350\text{ mA}$, T_{low} to T_{high} (Note 6), unless otherwise noted.)

| Characteristic | Symbol | Min | Typ | Max | Unit |
|---|-------------------------|-------|------------|------------|----------------------------|
| Output Voltage ($T_J = 25^\circ\text{C}$) | V_O | -11.5 | -12 | -12.5 | Vdc |
| Line Regulation, $T_J = 25^\circ\text{C}$ (Note 5) -14.5 Vdc $\geq V_I \geq$ -30 Vdc -15 Vdc $\geq V_I \geq$ -25 Vdc | Reg_{line} | - | 5.0 3.0 | 80 50 | mV |
| Load Regulation, $T_J = 25^\circ\text{C}$ (Note 5) $5.0\text{ mA} \leq I_O \leq 500\text{ mA}$ | Reg_{load} | - | 30 | 240 | mV |
| Output Voltage -14.5 Vdc $\geq V_I \geq$ -30 Vdc, $5.0\text{ mA} \leq I_O \leq 350\text{ mA}$ | V_O | -11.4 | - | -12.6 | Vdc |
| Input Bias Current ($T_J = 25^\circ\text{C}$) | I_{IB} | - | 4.4 | 8.0 | mA |
| Input Bias Current Change -14.5 Vdc $\geq V_I \geq$ -30 Vdc, $I_O = 350\text{ mA}$ $5.0\text{ mA} \leq I_O \leq 350\text{ mA}$, $V_I = -19\text{ V}$ | ΔI_{IB} | - | - | 0.4 0.4 | mA |
| Output Noise Voltage, $T_A = 25^\circ\text{C}$, $10\text{ Hz} \leq f \leq 100\text{ kHz}$ | V_n | - | 75 | - | μV |
| Ripple Rejection ($f = 120\text{ Hz}$) | RR | 54 | 60 | - | dB |
| Dropout Voltage $I_O = 500\text{ mA}$, $T_J = 25^\circ\text{C}$ | $V_I - V_O$ | - | 1.1 | - | Vdc |
| Average Temperature Coefficient of Output Voltage $I_O = 5.0\text{ mA}$, $0^\circ\text{C} \leq T_J \leq 125^\circ\text{C}$ | $\Delta V_O / \Delta T$ | - | -0.8 | - | $\text{mV}/^\circ\text{C}$ |

5. Load and line regulation are specified at constant temperature. Change in V_O due to heating effects must be taken into account separately. Pulse testing with low duty cycle is used.
6. B = T_{low} to T_{high} , $-40^\circ\text{C} < T_J < 125^\circ\text{C}$
C = T_{low} to T_{high} , $0^\circ\text{C} < T_J < 125^\circ\text{C}$

MC79M00 Series

MC79M15B, C

ELECTRICAL CHARACTERISTICS ($V_I = -23\text{ V}$, $I_O = 350\text{ mA}$, T_{low} to T_{high} (Note 8), unless otherwise noted.)

| Characteristic | Symbol | Min | Typ | Max | Unit |
|---|-------------------------|--------|------------|------------|----------------------------|
| Output Voltage ($T_J = 25^\circ\text{C}$) | V_O | -14.4 | -15 | -15.6 | Vdc |
| Line Regulation, $T_J = 25^\circ\text{C}$ (Note 7) -17.5 Vdc $\geq V_I \geq$ -30 Vdc -18 Vdc $\geq V_I \geq$ -28 Vdc | Reg_{line} | - | 5.0 3.0 | 80 50 | mV |
| Load Regulation, $T_J = 25^\circ\text{C}$ (Note 7) $5.0\text{ mA} \leq I_O \leq 500\text{ mA}$ | Reg_{load} | - | 30 | 240 | mV |
| Output Voltage -17.5 Vdc $\geq V_I \geq$ -30 Vdc, $5.0\text{ mA} \leq I_O \leq 350\text{ mA}$ | V_O | -14.25 | - | -15.75 | Vdc |
| Input Bias Current ($T_J = 25^\circ\text{C}$) | I_{IB} | - | 4.4 | 8.0 | mA |
| Input Bias Current Change -17.5 Vdc $\geq V_I \geq$ -30 Vdc, $I_O = 350\text{ mA}$ $5.0\text{ mA} \leq I_O \leq 350\text{ mA}$, $V_I = -23\text{ V}$ | ΔI_{IB} | - | - | 0.4 0.4 | mA |
| Output Noise Voltage, $T_A = 25^\circ\text{C}$, $10\text{ Hz} \leq f \leq 100\text{ kHz}$ | V_n | - | 90 | - | μV |
| Ripple Rejection ($f = 120\text{ Hz}$) | RR | 54 | 60 | - | dB |
| Dropout Voltage $I_O = 500\text{ mA}$, $T_J = 25^\circ\text{C}$ | $V_I - V_O$ | - | 1.1 | - | Vdc |
| Average Temperature Coefficient of Output Voltage $I_O = 5.0\text{ mA}$, $0^\circ\text{C} \leq T_J \leq 125^\circ\text{C}$ | $\Delta V_O / \Delta T$ | - | -1.0 | - | $\text{mV}/^\circ\text{C}$ |

7. Load and line regulation are specified at constant temperature. Change in V_O due to heating effects must be taken into account separately. Pulse testing with low duty cycle is used.
8. B = T_{low} to T_{high} , $-40^\circ\text{C} < T_J < 125^\circ\text{C}$
C = T_{low} to T_{high} , $0^\circ\text{C} < T_J < 125^\circ\text{C}$

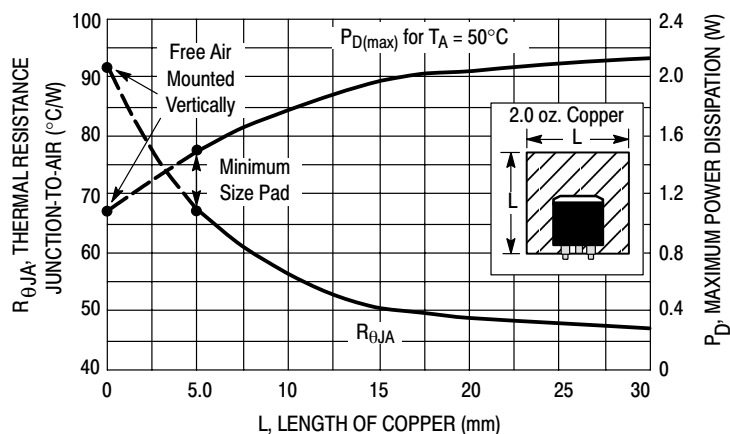

Figure 1. DPAK-3 Thermal Resistance and Maximum Power Dissipation versus P.C.B. Copper Length

MC79M00 Series

ORDERING INFORMATION

| Device | Output Voltage Tolerance | Operating Temperature Range | Package | Shipping† |
|---------------|--------------------------|--|--|-------------------|
| MC79M05BDT | 4.0% | $T_J = -40^{\circ}\text{C to } +125^{\circ}\text{C}$ | DPAK | 75 Units / Rail |
| MC79M05BDTG | | | DPAK (Pb-Free) | 75 Units / Rail |
| MC79M05BDTRK | | | DPAK | 2500 Units / Reel |
| MC79M05BDTRKG | | | DPAK (Pb-Free) | 2500 Units / Reel |
| MC79M05BT | | | TO-220 | 50 Units / Rail |
| MC79M05BTG | | | TO-220 (Pb-Free) | 50 Units / Rail |
| MC79M05CDT | | $T_J = 0^{\circ}\text{C to } +125^{\circ}\text{C}$ | DPAK | 75 Units / Rail |
| MC79M05CDTG | | | DPAK (Pb-Free) | 75 Units / Rail |
| MC79M05CDTRK | | | DPAK | 2500 Units / Reel |
| MC79M05CDTRKG | | | DPAK (Pb-Free) | 2500 Units / Reel |
| MC79M05CT | | | TO-220 | 50 Units / Rail |
| MC79M05CTG | | | TO-220 (Pb-Free) | 50 Units / Rail |
| MC79M08BDT | | $T_J = -40^{\circ}\text{C to } +125^{\circ}\text{C}$ | DPAK | 75 Units / Rail |
| MC79M08BDTRK | | | DPAK | 2500 Units / Reel |
| MC79M08BDTRKG | | | DPAK (Pb-Free) | 2500 Units / Reel |
| MC79M08BT | | | TO-220 | 50 Units / Rail |
| MC79M08BTG | | | TO-220 (Pb-Free) | 50 Units / Rail |
| MC79M08CDT | | | $T_J = 0^{\circ}\text{C to } +125^{\circ}\text{C}$ | DPAK |
| MC79M08CDTG | | DPAK (Pb-Free) | | 75 Units / Rail |
| MC79M08CDTRK | | DPAK | | 2500 Units / Reel |
| MC79M08CDTRKG | | DPAK (Pb-Free) | | 2500 Units / Reel |
| MC79M08CT | | TO-220 | | 50 Units / Rail |
| MC79M08CTG | | TO-220 (Pb-Free) | | 50 Units / Rail |
| MC79M12BDT | | $T_J = -40^{\circ}\text{C to } +125^{\circ}\text{C}$ | DPAK | 75 Units / Rail |
| MC79M12BDTG | | | DPAK (Pb-Free) | 75 Units / Rail |
| MC79M12BDTRK | | | DPAK | 2500 Units / Reel |
| MC79M12BDTRKG | | | DPAK (Pb-Free) | 2500 Units / Reel |
| MC79M12BT | | | TO-220 | 50 Units / Rail |
| MC79M12BTG | | | TO-220 (Pb-Free) | 50 Units / Rail |
| MC79M12CDT | | $T_J = 0^{\circ}\text{C to } +125^{\circ}\text{C}$ | DPAK | 75 Units / Rail |
| MC79M12CDTG | DPAK (Pb-Free) | | 75 Units / Rail | |
| MC79M12CDTRK | DPAK | | 2500 Units / Reel | |
| MC79M12CDTRKG | DPAK (Pb-Free) | | 2500 Units / Reel | |
| MC79M12CT | TO-220 | | 50 Units / Rail | |
| MC79M12CTG | TO-220 (Pb-Free) | | 50 Units / Rail | |

†For information on tape and reel specifications, including part orientation and tape sizes, please refer to our Tape and Reel Packaging Specifications Brochure, BRD8011/D.

MC79M00 Series

ORDERING INFORMATION

| Device | Output Voltage Tolerance | Operating Temperature Range | Package | Shipping† |
|---------------|--------------------------|---|------------------|-------------------|
| MC79M15BDT | 4.0% | $T_J = -40^{\circ}\text{C}$ to $+125^{\circ}\text{C}$ | DPAK | 75 Units / Rail |
| MC79M15BDTG | | | DPAK (Pb-Free) | 75 Units / Rail |
| MC79M15BDTRK | | | DPAK | 2500 Units / Reel |
| MC79M15BDTRKG | | | DPAK (Pb-Free) | 2500 Units / Reel |
| MC79M15BT | | | TO-220 | 50 Units / Rail |
| MC79M15BTG | | | TO-220 (Pb-Free) | 50 Units / Rail |
| MC79M15CDT | | $T_J = 0^{\circ}\text{C}$ to $+125^{\circ}\text{C}$ | DPAK | 75 Units / Rail |
| MC79M15CDTG | | | DPAK (Pb-Free) | 75 Units / Rail |
| MC79M15CDTRK | | | DPAK | 2500 Units / Reel |
| MC79M15CDTRKG | | | DPAK (Pb-Free) | 2500 Units / Reel |
| MC79M15CT | | | TO-220 | 50 Units / Rail |
| MC79M15CTG | | | TO-220 (Pb-Free) | 50 Units / Rail |

†For information on tape and reel specifications, including part orientation and tape sizes, please refer to our Tape and Reel Packaging Specifications Brochure, BRD8011/D.

MC79M00 Series

PACKAGE DIMENSIONS

TO-220, SINGLE GAUGE
T SUFFIX
CASE 221AB-01
ISSUE O

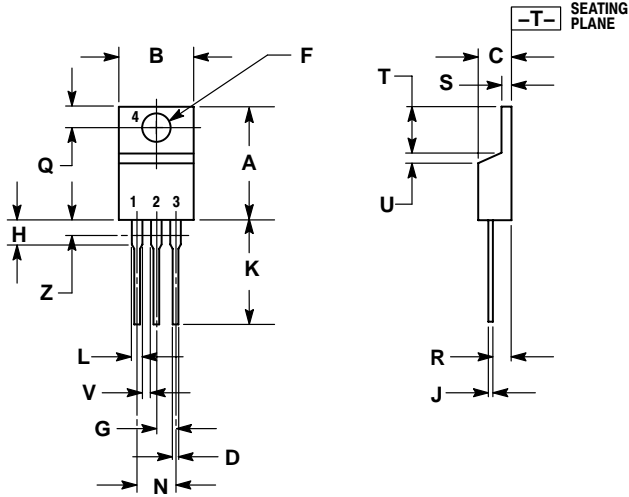

NOTES:

1. DIMENSIONING AND TOLERANCING PER ANSI Y14.5M, 1982.
2. CONTROLLING DIMENSION: INCH.
3. DIMENSION Z DEFINES A ZONE WHERE ALL BODY AND LEAD IRREGULARITIES ARE ALLOWED.

| DIM | INCHES | | MILLIMETERS | |
|-----|--------|-------|-------------|-------|
| | MIN | MAX | MIN | MAX |
| A | 0.570 | 0.620 | 14.48 | 15.75 |
| B | 0.380 | 0.405 | 9.66 | 10.28 |
| C | 0.160 | 0.190 | 4.07 | 4.82 |
| D | 0.025 | 0.035 | 0.64 | 0.88 |
| F | 0.142 | 0.147 | 3.61 | 3.73 |
| G | 0.095 | 0.105 | 2.42 | 2.66 |
| H | 0.110 | 0.155 | 2.80 | 3.93 |
| J | 0.018 | 0.025 | 0.46 | 0.64 |
| K | 0.500 | 0.562 | 12.70 | 14.27 |
| L | 0.045 | 0.060 | 1.15 | 1.52 |
| N | 0.190 | 0.210 | 4.83 | 5.33 |
| Q | 0.100 | 0.120 | 2.54 | 3.04 |
| R | 0.080 | 0.110 | 2.04 | 2.79 |
| S | 0.020 | 0.055 | 0.508 | 1.39 |
| T | 0.235 | 0.255 | 5.97 | 6.47 |
| U | 0.000 | 0.050 | 0.00 | 1.27 |
| V | 0.045 | --- | 1.15 | --- |
| Z | --- | 0.080 | --- | 2.04 |

MC79M00 Series

PACKAGE DIMENSIONS

DPAK-3
DT SUFFIX
CASE 369C-01
ISSUE O

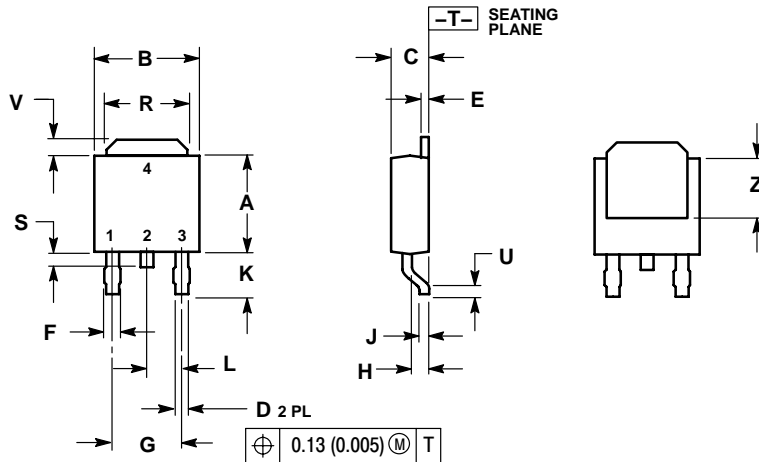

- NOTES:
1. DIMENSIONING AND TOLERANCING PER ANSI Y14.5M, 1982.
2. CONTROLLING DIMENSION: INCH.

| DIM | INCHES | | MILLIMETERS | |
|-----|-----------|-------|-------------|------|
| | MIN | MAX | MIN | MAX |
| A | 0.235 | 0.245 | 5.97 | 6.22 |
| B | 0.250 | 0.265 | 6.35 | 6.73 |
| C | 0.086 | 0.094 | 2.19 | 2.38 |
| D | 0.027 | 0.035 | 0.69 | 0.88 |
| E | 0.018 | 0.023 | 0.46 | 0.58 |
| F | 0.037 | 0.045 | 0.94 | 1.14 |
| G | 0.180 BSC | | 4.58 BSC | |
| H | 0.034 | 0.040 | 0.87 | 1.01 |
| J | 0.018 | 0.023 | 0.46 | 0.58 |
| K | 0.102 | 0.114 | 2.60 | 2.89 |
| L | 0.090 BSC | | 2.29 BSC | |
| R | 0.180 | 0.215 | 4.57 | 5.45 |
| S | 0.025 | 0.040 | 0.63 | 1.01 |
| U | 0.020 | --- | 0.51 | --- |
| V | 0.035 | 0.050 | 0.89 | 1.27 |
| Z | 0.155 | --- | 3.93 | --- |

SOLDERING FOOTPRINT*

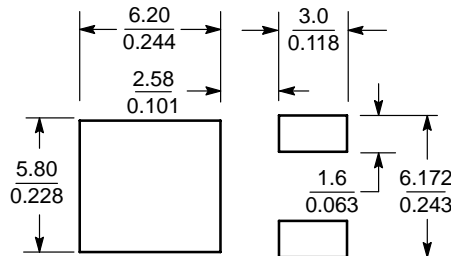

SCALE 3:1 (mm / inches)

*For additional information on our Pb-Free strategy and soldering details, please download the ON Semiconductor Soldering and Mounting Techniques Reference Manual, SOLDERRM/D.

ON Semiconductor and are registered trademarks of Semiconductor Components Industries, LLC (SCILLC). SCILLC reserves the right to make changes without further notice to any products herein. SCILLC makes no warranty, representation or guarantee regarding the suitability of its products for any particular purpose, nor does SCILLC assume any liability arising out of the application or use of any product or circuit, and specifically disclaims any and all liability, including without limitation special, consequential or incidental damages. "Typical" parameters which may be provided in SCILLC data sheets and/or specifications can and do vary in different applications and actual performance may vary over time. All operating parameters, including "Typicals" must be validated for each customer application by customer's technical experts. SCILLC does not convey any license under its patent rights nor the rights of others. SCILLC products are not designed, intended, or authorized for use as components in systems intended for surgical implant into the body, or other applications intended to support or sustain life, or for any other application in which the failure of the SCILLC product could create a situation where personal injury or death may occur. Should Buyer purchase or use SCILLC products for any such unintended or unauthorized application, Buyer shall indemnify and hold SCILLC and its officers, employees, subsidiaries, affiliates, and distributors harmless against all claims, costs, damages, and expenses, and reasonable attorney fees arising out of, directly or indirectly, any claim of personal injury or death associated with such unintended or unauthorized use, even if such claim alleges that SCILLC was negligent regarding the design or manufacture of the part. SCILLC is an Equal Opportunity/Affirmative Action Employer. This literature is subject to all applicable copyright laws and is not for resale in any manner.

PUBLICATION ORDERING INFORMATION

LITERATURE FULFILLMENT:
Literature Distribution Center for ON Semiconductor
P.O. Box 5163, Denver, Colorado 80217 USA
Phone: 303-675-2175 or 800-344-3860 Toll Free USA/Canada
Fax: 303-675-2176 or 800-344-3867 Toll Free USA/Canada
Email: orderlit@onsemi.com

N. American Technical Support: 800-282-9855 Toll Free
USA/Canada
Europe, Middle East and Africa Technical Support:
Phone: 421 33 790 2910
Japan Customer Focus Center
Phone: 81-3-5773-3850

ON Semiconductor Website: www.onsemi.com

Order Literature: <http://www.onsemi.com/orderlit>

For additional information, please contact your local Sales Representative