

Distributed by:

JAMECO[®]
ELECTRONICS

www.Jameco.com ♦ 1-800-831-4242

The content and copyrights of the attached
material are the property of its owner.

Jameco Part Number 2039136

Single-Phase Single In-Line Bridge Rectifiers

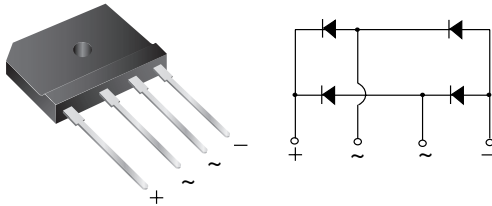

Case Style GSIB-5S

FEATURES

- UL recognition file number E54214
- Thin single in-line package
- Glass passivated chip junction
- High surge current capability
- High case dielectric strength of 2500 V_{RMS}
- Solder dip 260 °C, 40 s
- Component in accordance to RoHS 2002/95/EC and WEEE 2002/96/EC

RoHS
COMPLIANT

TYPICAL APPLICATIONS

General purpose use in ac-to-dc bridge full wave rectification for switching power supply, home appliances, office equipment, industrial automation applications.

PRIMARY CHARACTERISTICS	
$I_{F(AV)}$	25 A
V_{RRM}	200 V to 800 V
I_{FSM}	350 A
I_R	10 μ A
V_F	1.0 V
T_J max.	150 °C

MECHANICAL DATA

Case: GSIB-5S

Epoxy meets UL 94V-0 flammability rating

Terminals: Matte tin plated leads, solderable per J-STD-002 and JESD22-B102

E3 suffix for consumer grade, meets JESD 201 class 1A whisker test

Polarity: As marked on body

Mounting Torque: 10 cm-kg (8.8 inches-lbs) max.

Recommended Torque: 5.7 cm-kg (5 inches-lbs)

MAXIMUM RATINGS ($T_A = 25$ °C unless otherwise noted)						
PARAMETER	SYMBOL	GSIB2520	GSIB2540	GSIB2560	GSIB2580	UNIT
Maximum repetitive peak reverse voltage	V_{RRM}	200	400	600	800	V
Maximum RMS voltage	V_{RMS}	140	280	420	560	V
Maximum DC blocking voltage	V_{DC}	200	400	600	800	V
Maximum average forward rectified output current at $T_C = 98$ °C $T_A = 25$ °C	$I_{F(AV)}$	25 ⁽¹⁾ 3.5 ⁽²⁾				A
Peak forward surge current single sine-wave superimposed on rated load	I_{FSM}	350				A
Rating for fusing ($t < 8.3$ ms)	I^2t	500				A ² s
Operating junction and storage temperature range	T_J, T_{STG}	- 55 to + 150				°C

Notes:

(1) Unit case mounted on aluminum plate heatsink

(2) Units mounted on P.C.B. without heatsink

ELECTRICAL CHARACTERISTICS ($T_A = 25\text{ }^\circ\text{C}$ unless otherwise noted)							
PARAMETER	TEST CONDITIONS	SYMBOL	GSIB2520	GSIB2540	GSIB2560	GSIB2580	UNIT
Maximum instantaneous forward voltage drop per diode	12.5 A	V_F	1.00				V
Maximum DC reverse current at rated DC blocking voltage per diode	$T_A = 25\text{ }^\circ\text{C}$ $T_A = 125\text{ }^\circ\text{C}$	I_R	10 350				μA

THERMAL CHARACTERISTICS ($T_A = 25\text{ }^\circ\text{C}$ unless otherwise noted)							
PARAMETER	SYMBOL	GSIB2520	GSIB2540	GSIB2560	GSIB2580	UNIT	
Typical thermal resistance	$R_{\theta JA}$ $R_{\theta JC}$	22 ⁽²⁾ 1.0 ⁽¹⁾				$^\circ\text{C/W}$	

Notes:

- (1) Unit case mounted on aluminum plate heatsink
- (2) Units mounted on P.C.B. without heatsink
- (3) Recommended mounting position is to bolt down on heatsink with silicone thermal compound for maximum heat transfer with #6 screw

ORDERING INFORMATION (Example)				
PREFERRED P/N	UNIT WEIGHT (g)	PREFERRED PACKAGE CODE	BASE QUANTITY	DELIVERY MODE
GSIB2560-E3/45	7.0	45	20	Tube

RATINGS AND CHARACTERISTICS CURVES

($T_A = 25\text{ }^\circ\text{C}$ unless otherwise noted)

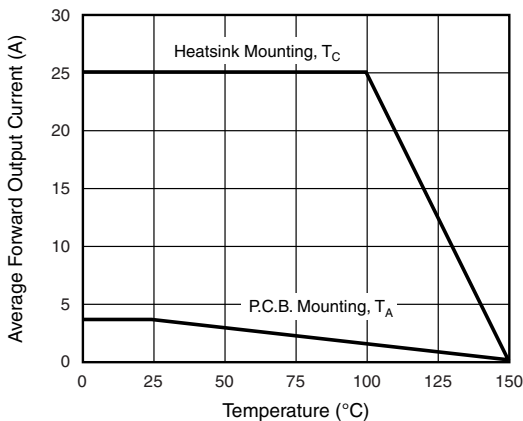

Figure 1. Derating Curve Output Rectified Current

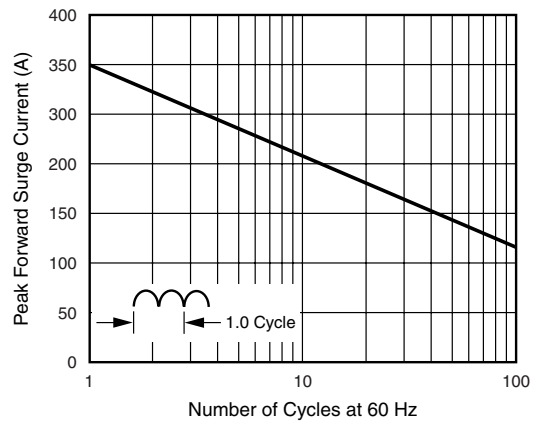

Figure 2. Maximum Non-Repetitive Peak Forward Surge Current Per Diode

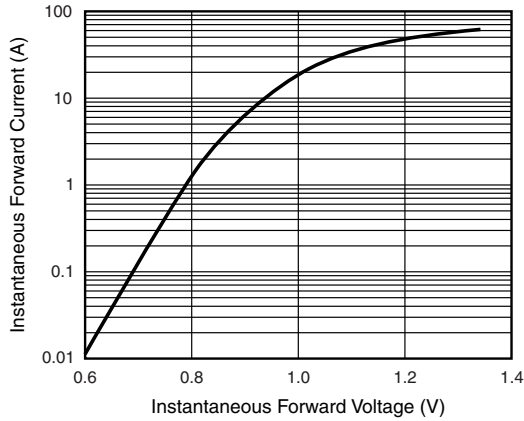

Figure 3. Typical Forward Characteristics Per Diode

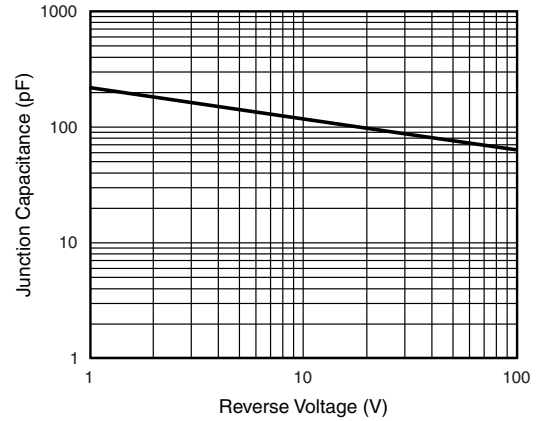

Figure 5. Typical Junction Capacitance Per Diode

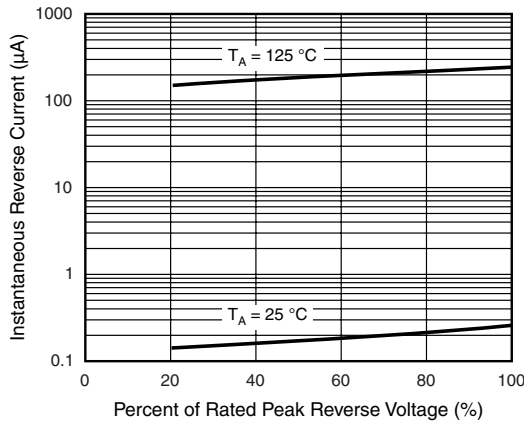

Figure 4. Typical Reverse Characteristics Per Diode

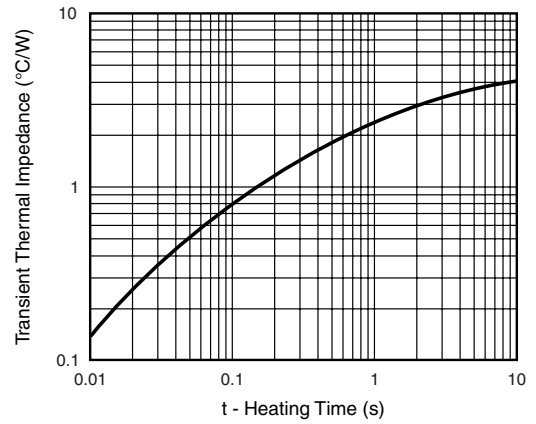
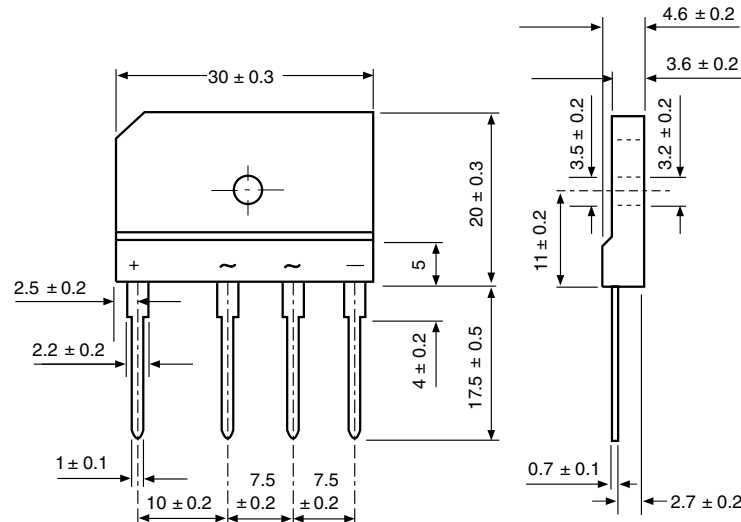

Figure 6. Typical Transient Thermal Impedance

PACKAGE OUTLINE DIMENSIONS in millimeters

Case Style GSIB-5S





Notice

Specifications of the products displayed herein are subject to change without notice. Vishay Intertechnology, Inc., or anyone on its behalf, assumes no responsibility or liability for any errors or inaccuracies.

Information contained herein is intended to provide a product description only. No license, express or implied, by estoppel or otherwise, to any intellectual property rights is granted by this document. Except as provided in Vishay's terms and conditions of sale for such products, Vishay assumes no liability whatsoever, and disclaims any express or implied warranty, relating to sale and/or use of Vishay products including liability or warranties relating to fitness for a particular purpose, merchantability, or infringement of any patent, copyright, or other intellectual property right.

The products shown herein are not designed for use in medical, life-saving, or life-sustaining applications. Customers using or selling these products for use in such applications do so at their own risk and agree to fully indemnify Vishay for any damages resulting from such improper use or sale.