

Distributed by:

JAMECO[®]
ELECTRONICS

www.Jameco.com ♦ 1-800-831-4242

The content and copyrights of the attached
material are the property of its owner.

Jameco Part Number 2041990

NDP7060 / NDB7060 N-Channel Enhancement Mode Field Effect Transistor

General Description

These N-Channel enhancement mode power field effect transistors are produced using Fairchild's proprietary, high cell density, DMOS technology. This very high density process is especially tailored to minimize on-state resistance, provide superior switching performance, and withstand high energy pulses in the avalanche and commutation modes. These devices are particularly suited for low voltage applications such as automotive, DC/DC converters, PWM motor controls, and other battery powered circuits where fast switching, low in-line power loss, and resistance to transients are needed.

Features

- 75A, 60V. $R_{DS(ON)} = 0.013\Omega @ V_{GS}=10V$.
- Critical DC electrical parameters specified at elevated temperature.
- Rugged internal source-drain diode can eliminate the need for an external Zener diode transient suppressor.
- 175°C maximum junction temperature rating.
- High density cell design for extremely low $R_{DS(ON)}$.
- TO-220 and TO-263 (D²PAK) package for both through hole and surface mount applications.

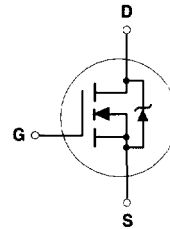
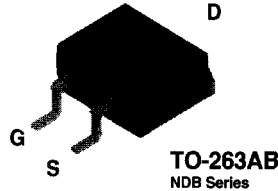
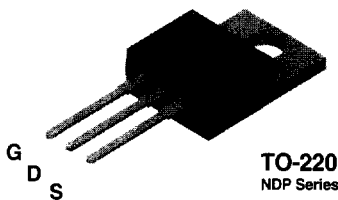

4

Absolute Maximum Ratings $T_c = 25^\circ\text{C}$ unless otherwise noted

Symbol	Parameter	NDP7060	NDB7060	Units
V_{DSS}	Drain-Source Voltage	60		V
V_{DGR}	Drain-Gate Voltage ($R_{GS} \leq 1\text{ M}\Omega$)	60		V
V_{GSS}	Gate-Source Voltage - Continuous - Nonrepetitive ($t_p < 50\ \mu\text{s}$)	± 20		V
		± 40		
I_b	Drain Current - Continuous - Pulsed	75		A
		225		
P_o	Maximum Power Dissipation @ $T_c = 25^\circ\text{C}$ Derate above 25°C	150		W
		1		
T_j, T_{STG}	Operating and Storage Temperature Range	-65 to 175		$^\circ\text{C}$
T_L	Maximum lead temperature for soldering purposes, 1/8" from case for 5 seconds	275		$^\circ\text{C}$

Electrical Characteristics ($T_c = 25^\circ\text{C}$ unless otherwise noted)

Symbol	Parameter	Conditions	Min	Typ	Max	Units
DRAIN-SOURCE AVALANCHE RATINGS (Note 1)						
W_{DSS}	Single Pulse Drain-Source Avalanche Energy	$V_{DD} = 25\text{ V}, I_D = 75\text{ A}$			550	mJ
I_{AR}	Maximum Drain-Source Avalanche Current				75	A
OFF CHARACTERISTICS						
BV_{DSS}	Drain-Source Breakdown Voltage	$V_{GS} = 0\text{ V}, I_D = 250\ \mu\text{A}$	60			V
I_{DSS}	Zero Gate Voltage Drain Current	$V_{DS} = 60\text{ V}, V_{GS} = 0\text{ V}$			250	μA
			$T_J = 125^\circ\text{C}$		1	mA
I_{GSSF}	Gate - Body Leakage, Forward	$V_{GS} = 20\text{ V}, V_{DS} = 0\text{ V}$			100	nA
I_{GSSR}	Gate - Body Leakage, Reverse	$V_{GS} = -20\text{ V}, V_{DS} = 0\text{ V}$			-100	nA
ON CHARACTERISTICS (Note 1)						
$V_{GS(th)}$	Gate Threshold Voltage	$V_{DS} = V_{GS}, I_D = 250\ \mu\text{A}$	2	2.8	4	V
			$T_J = 125^\circ\text{C}$	1.4	2.1	
$R_{DS(on)}$	Static Drain-Source On-Resistance	$V_{GS} = 10\text{ V}, I_D = 40\text{ A}$		0.01	0.013	Ω
			$T_J = 125^\circ\text{C}$		0.015	
$I_{D(on)}$	On-State Drain Current	$V_{GS} = 10\text{ V}, V_{DS} = 10\text{ V}$	75			A
g_{FS}	Forward Transconductance	$V_{DS} = 10\text{ V}, I_D = 37.5\text{ A}$	15	39		S
DYNAMIC CHARACTERISTICS						
C_{iss}	Input Capacitance	$V_{DS} = 25\text{ V}, V_{GS} = 0\text{ V},$ $f = 1.0\text{ MHz}$		2960	3600	pF
C_{oss}	Output Capacitance			1130	1600	
C_{rss}	Reverse Transfer Capacitance			380	800	
SWITCHING CHARACTERISTICS (Note 1)						
$t_{D(on)}$	Turn - On Delay Time	$V_{DD} = 30\text{ V}, I_D = 75\text{ A},$ $V_{GS} = 10\text{ V}, R_{GEN} = 5\ \Omega$		17	30	nS
t_r	Turn - On Rise Time			128	400	
$t_{D(off)}$	Turn - Off Delay Time			54	80	
t_f	Turn - Off Fall Time			90	200	
Q_g	Total Gate Charge	$V_{DS} = 48\text{ V},$ $I_D = 75\text{ A}, V_{GS} = 10\text{ V}$		100	115	nC
Q_{gs}	Gate-Source Charge			14.5		
Q_{gd}	Gate-Drain Charge			51		

Electrical Characteristics ($T_c = 25^\circ\text{C}$ unless otherwise noted)

Symbol	Parameter	Conditions	Min	Typ	Max	Units	
DRAIN-SOURCE DIODE CHARACTERISTICS							
I_S	Maximum Continuous Drain-Source Diode Forward Current				75	A	
I_{SM}	Maximum Pulsed Drain-Source Diode Forward Current				225	A	
V_{SD}	Drain-Source Diode Forward Voltage	$V_{GS} = 0\text{ V}, I_S = 37.5\text{ A}$ (Note 1)			0.9	1.3	V
				$T_j = 125^\circ\text{C}$	0.84	1.2	
t_r	Reverse Recovery Time	$V_{GS} = 0\text{ V}, I_F = 75\text{ A}, dI_F/dt = 100\text{ A}/\mu\text{s}$	40	76	150	ns	
I_r	Reverse Recovery Current		2	4.7	10	A	
THERMAL CHARACTERISTICS							
$R_{\theta JC}$	Thermal Resistance, Junction-to-Case				1	$^\circ\text{C}/\text{W}$	
$R_{\theta JA}$	Thermal Resistance, Junction-to-Ambient				62.5	$^\circ\text{C}/\text{W}$	

Note:

1. Pulse Test: Pulse Width $\leq 300\ \mu\text{s}$. Duty Cycle $\leq 2.0\%$.

Typical Electrical Characteristics

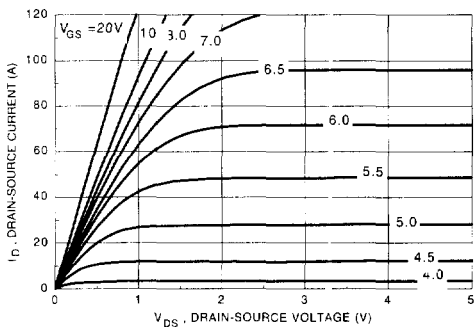

Figure 1. On-Region Characteristics

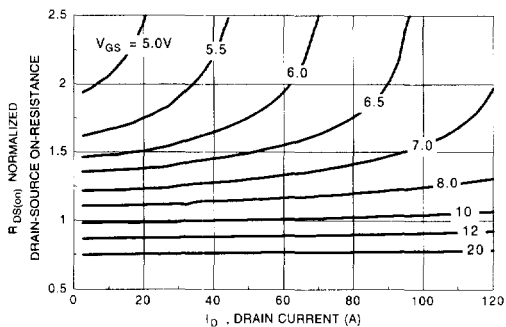

Figure 2. On-Resistance Variation with Gate Voltage and Drain Current

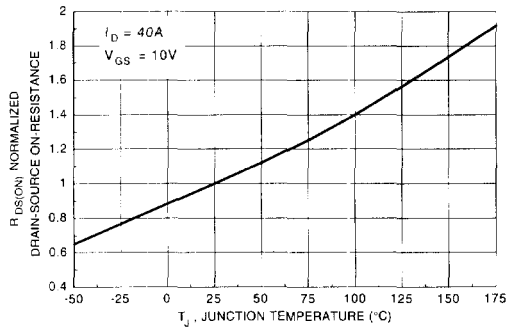

Figure 3. On-Resistance Variation with Temperature

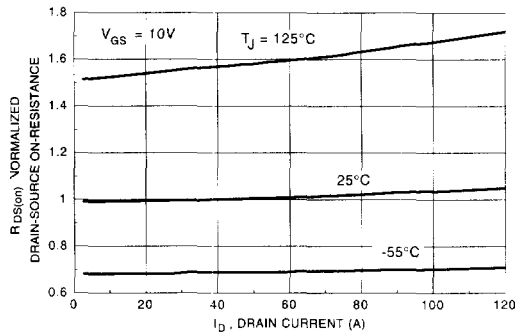

Figure 4. On-Resistance Variation with Drain Current and Temperature

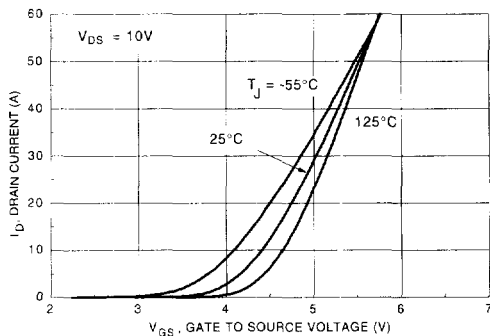

Figure 5. Transfer Characteristics

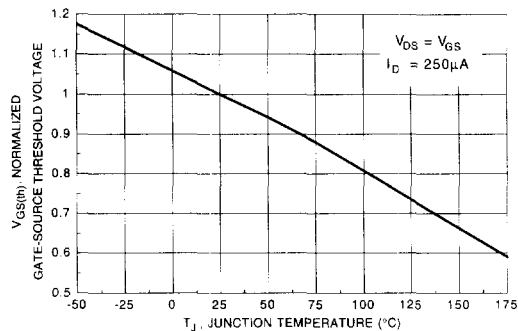

Figure 6. Gate Threshold Variation with Temperature

Typical Electrical Characteristics (continued)

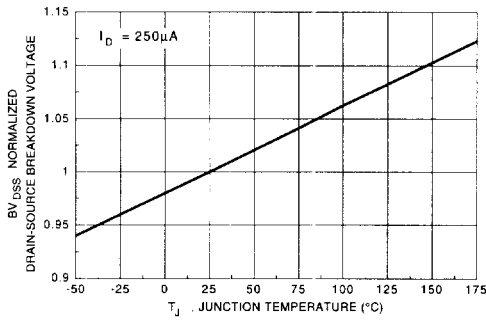

Figure 7. Breakdown Voltage Variation with Temperature

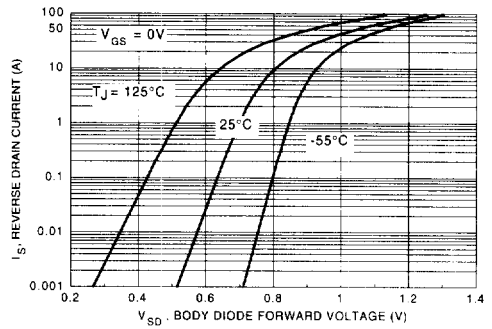

Figure 8. Body Diode Forward Voltage Variation with Current and Temperature

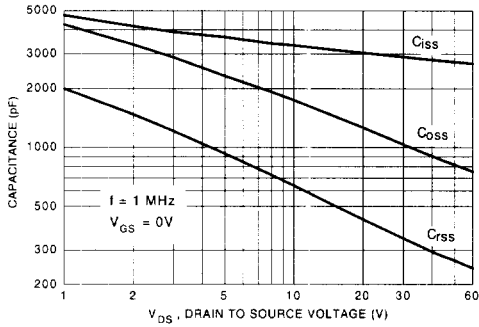

Figure 9. Capacitance Characteristics

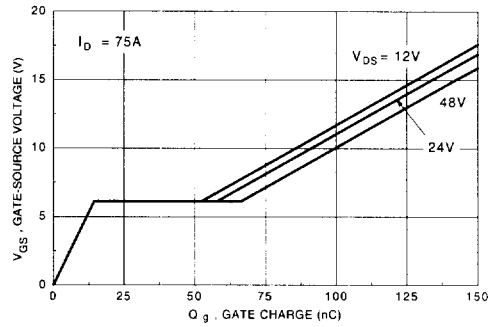

Figure 10. Gate Charge Characteristics

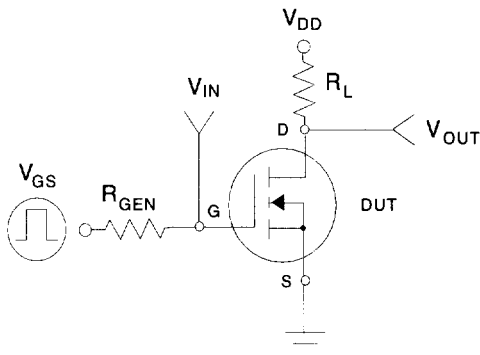

Figure 11. Switching Test Circuit

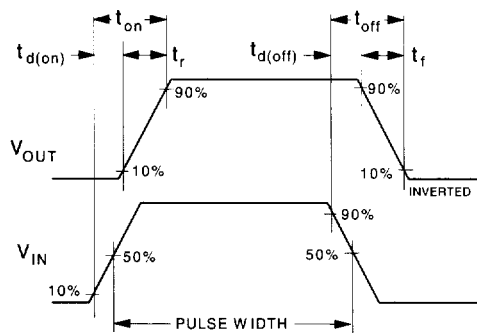

Figure 12. Switching Waveforms

Typical Electrical Characteristics (continued)

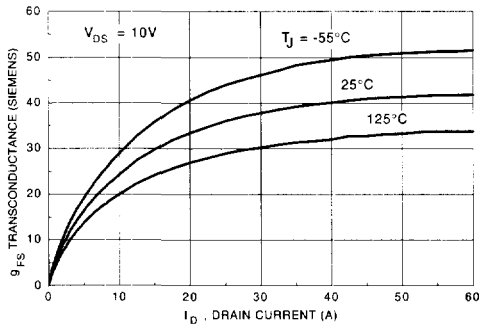

Figure 13. Transconductance Variation with Drain Current and Temperature

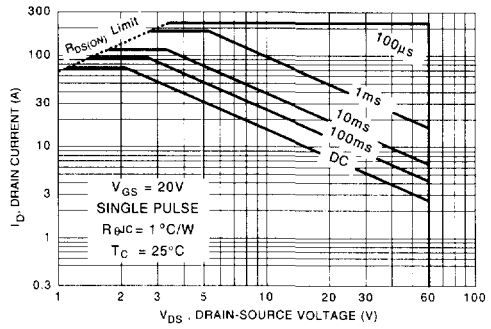

Figure 14. Maximum Safe Operating Area

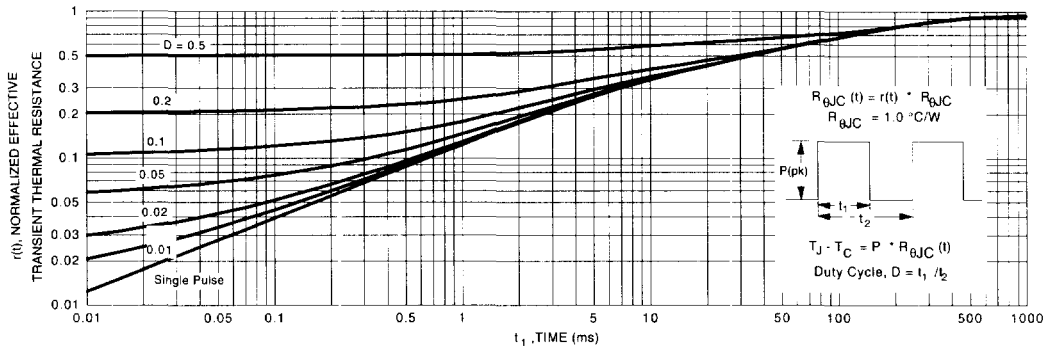

Figure 15. Transient Thermal Response Curve