

Distributed by:

JAMECO[®]
ELECTRONICS

www.Jameco.com ♦ 1-800-831-4242

The content and copyrights of the attached
material are the property of its owner.

Jameco Part Number 2082231

THIS DRAWING IS UNPUBLISHED. RELEASED FOR PUBLICATION ,19 .
 © COPYRIGHT 1974,75,80,81,90 BY AMP INCORPORATED. ALL INTERNATIONAL RIGHTS RESERVED.

LOC	DIST	P	F	ZONE	LTR	REVISIONS	DATE	APPD
AG	1				AM	REV PER 063C-0014-02	28JUN02	HW

- FOR ADDITIONAL SPECIFICATIONS SEE AMP PRODUCT SPEC 108-7532.
 - SWITCH SHOWN IN OPEN POSITION.
 - ALL CHARACTERS AND ROCKERS ARE WHITE, HOUSING IS BLUE.
 - STAMPING WILL VARY ON 2 AND 3 POSITION SIDES DUE TO SPACE RESTRICTIONS.
- △ .315 DIMENSION APPLIES AT TERMINAL TIPS.
 TERMINALS ARE $.300^{+.010}_{-.000}$ AT MOUNTING SURFACE.
- △ STRIPPABLE TRANSPARENT SEAL, SEE FIG 1.

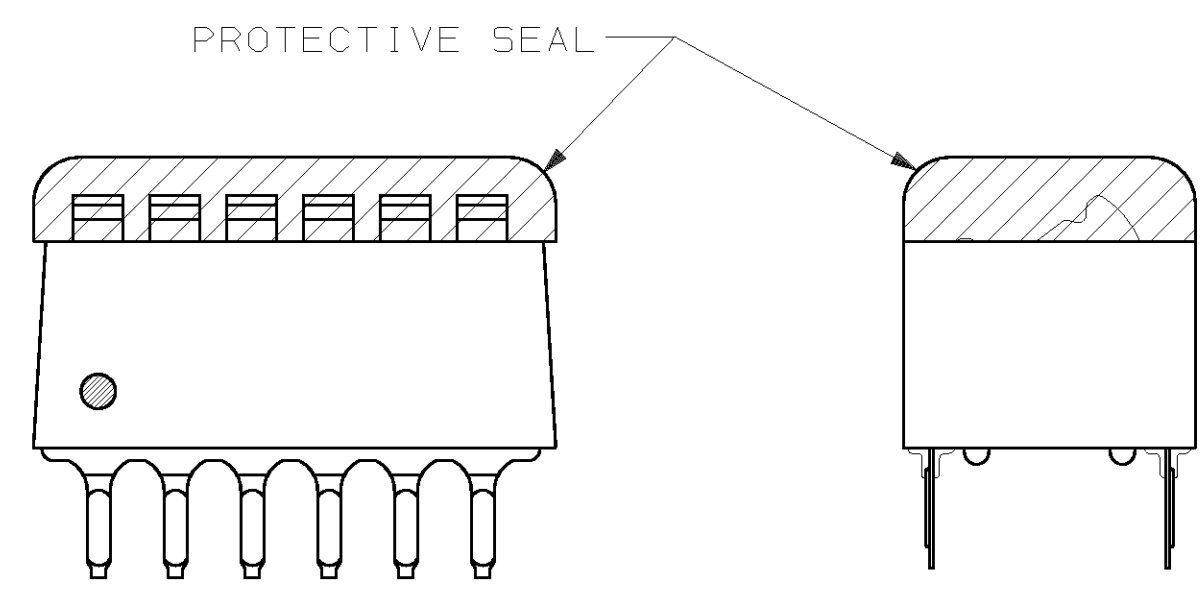
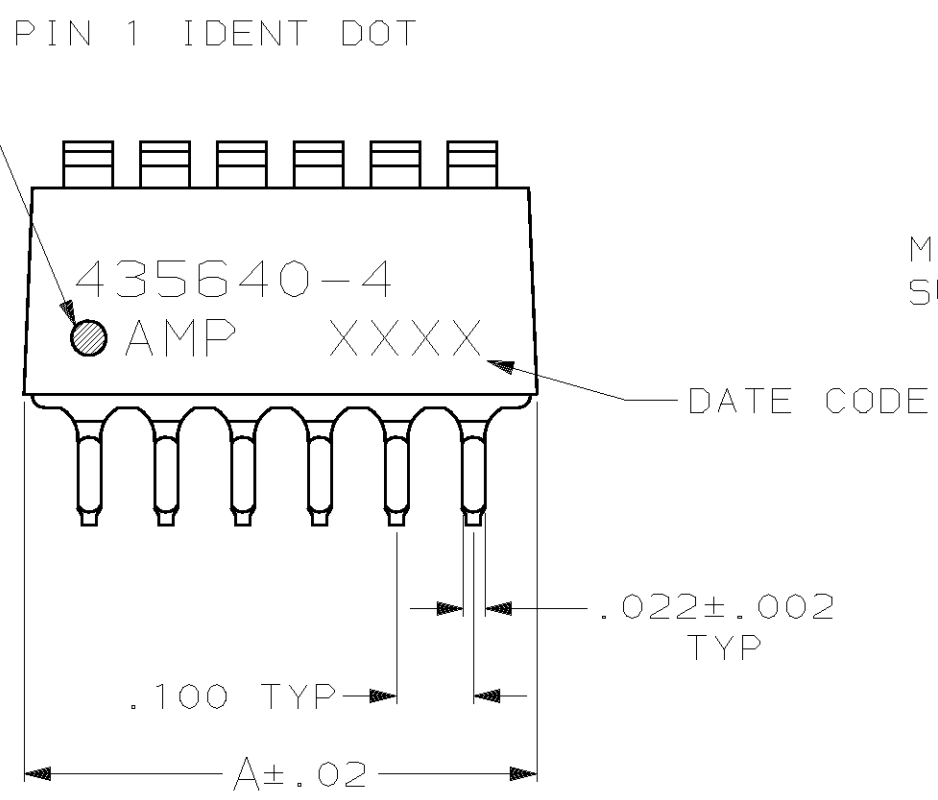
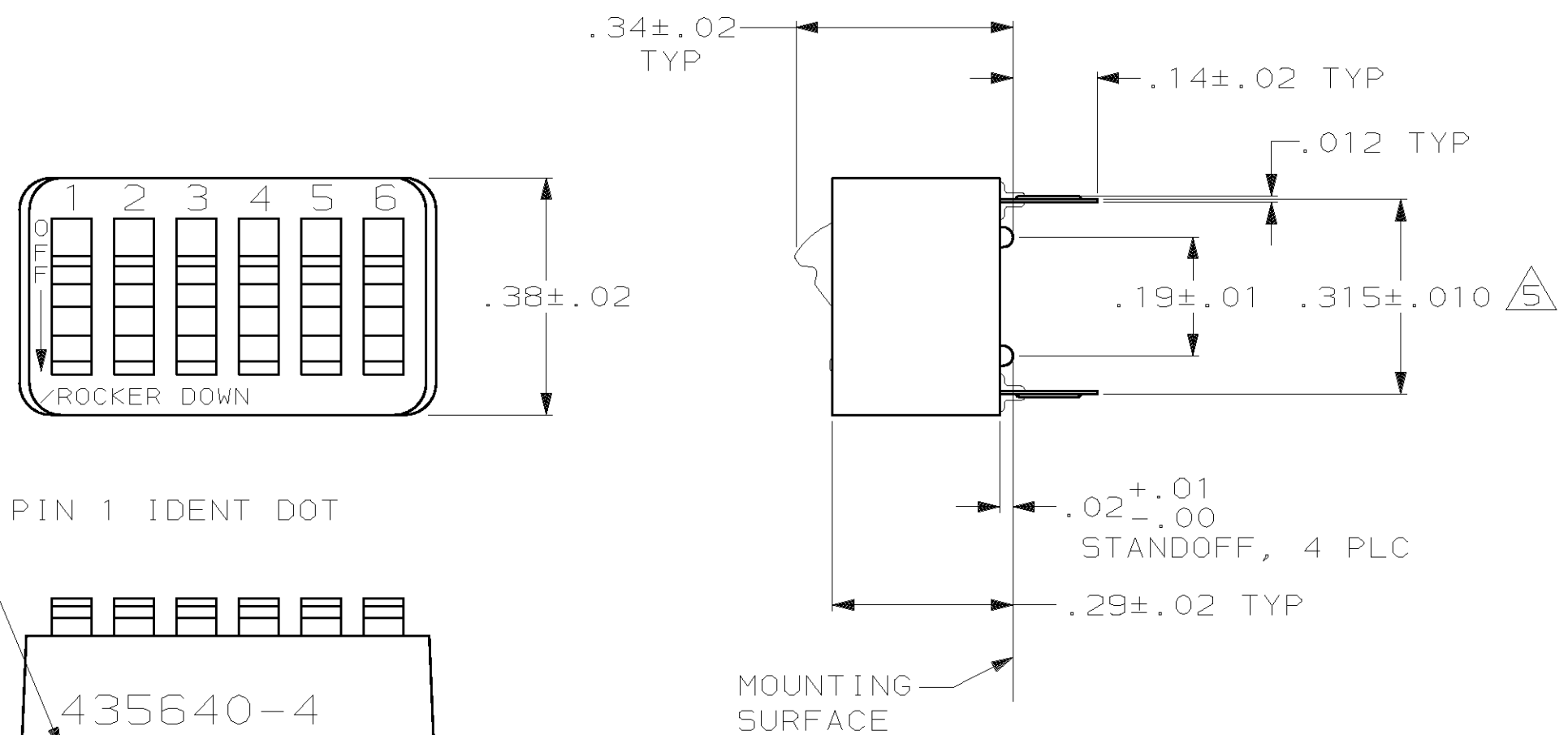

FIG 1

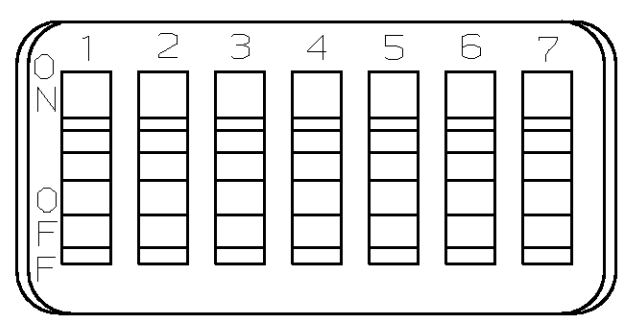

FIG 2

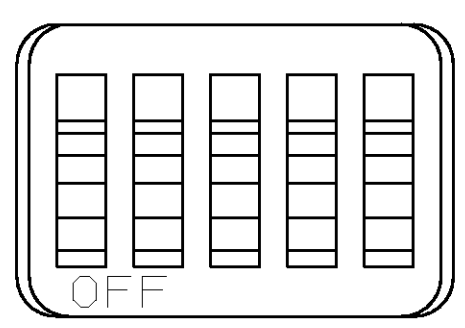

FIG 3

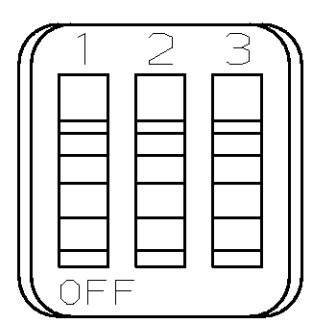

FIG 4

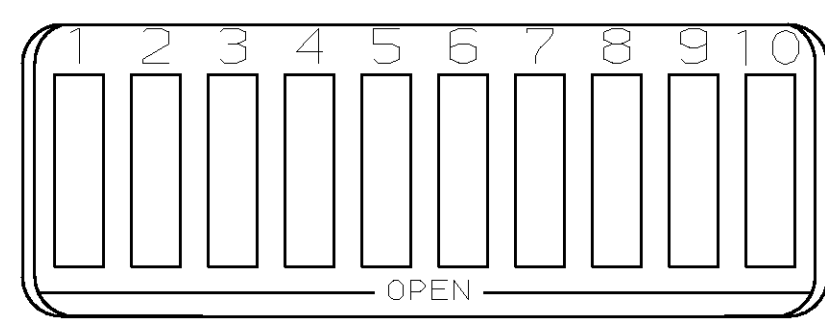

FIG 5

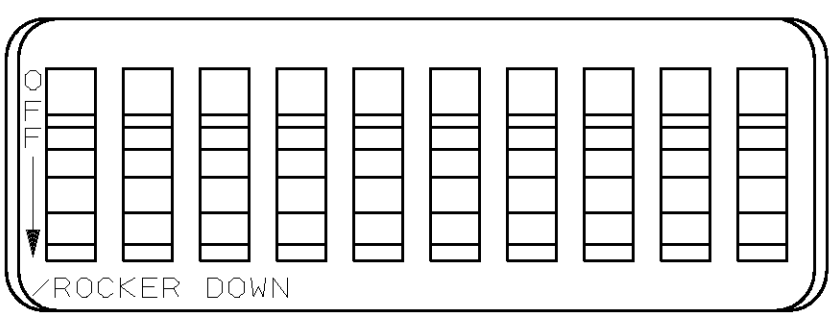

FIG 6

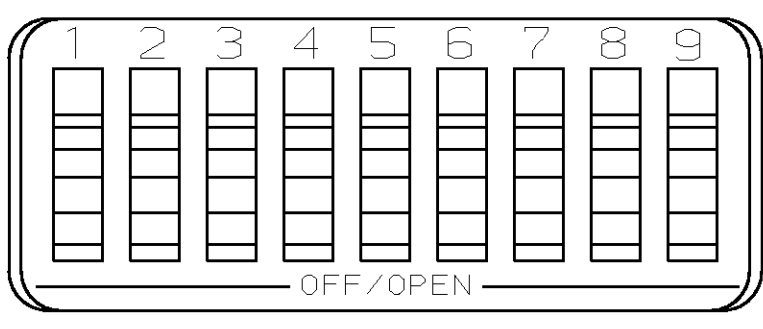

FIG 7

DO NOT SCALE PRINT. UNLESS SPECIFIED DIMENSIONS IN INCHES TOLERANCES ON : 2 PLC DEC ± - 3 PLC DEC ± .005 ANGLES ± -		DR R.TALLEY 11-15-89	AMP INCORPORATED Harrisburg, Pa. 17105	
MATERIAL HOUSING & ROCKERS; POLYESTER CONTACTS; COPPER ALLOY	APPD H.LEITER 3-6-90 APPD M.STADDON 3-6-90	CHK R.L.MILLER 3-6-90	NAME SWITCH ASSY, DIP, TYPE C, 7100 SERIES, SPST, STANDARD	
FINISH CONTACTS; PLATED .000030 MIN GOLD IN CONTACT AREA OVER .000050 MIN NICKEL	APPLICATION SPEC -	DR -	SIZE C	CAGE CODE 00779
WEIGHT -		APPD -	SCALE 4:1	DRAWING NO 435640
				SHEET 1 OF 1

FIG	SEAL	NO OF POSN	PART NO	
FIG 6	---	1.08 10	6-435640-1	
FIG 7	---	.58 5	6-435640-0	
	---	.48 4	5-435640-9	
	---	.88 8	5-435640-8	
	---	.98 9	5-435640-7	
FIG 5	△6	.68 6	5-435640-6	
	---	.58 5	5-435640-5	
	---	.48 4	5-435640-4	
FIG 2	△6	.88 8	5-435640-3	
OBSOLETE FIG 5	△6	.88 8	5-435640-2	
	---	1.08 10	5-435640-1	
FIG 3	△6	.88 8	5-435640-0	
	---	.88 8	4-435640-9	
	---	.58 5	4-435640-8	
NONE	---	1.08 10	4-435640-7	
AS SHOWN	△6	1.28 12	4-435640-3	
		1.08 10	4-435640-1	
		.98 9	4-435640-0	
		.88 8	3-435640-9	
		.78 7	3-435640-8	
		.68 6	3-435640-7	
		.58 5	3-435640-6	
.48 4	3-435640-5			
OBSOLETE OBSOLETE FIG 4	---	.38 3	3-435640-4	
		.28 2	3-435640-3	
AS SHOWN	---	1.28 12	3-435640-2	
FIG 4	---	.38 3	3-435640-0	
		.28 2	2-435640-9	
OBSOLETE FIG 2	---	.78 7	2-435640-2	
AS SHOWN	---	1.08 10	435640-7	
		.98 9	435640-6	
		.88 8	435640-5	
		.68 6	435640-4	
		.58 5	435640-3	
		.48 4	435640-2	
		.78 7	435640-1	
		TOP MARKING	PROTECTIVE SEAL	A