



■ Features :

- Universal AC input / Full range
- Built-in 5V/0.3A auxiliary power
- Built-in active PFC function, PF>0.96
- Protections: Short circuit / Overload / Over voltage / Over temperature
- Forced air cooling by built-in DC fan with fan speed control
- Low profile:1U height
- Active current sharing up to 3000W (3 units)in 19" rack, 3 racks max. can be operated in parallel (up to 8 units) (Note.7)
- Remote control for single unit
- Built-in remote sense function
- Output voltage trimming function
- Hot-swap operation
- Optional I²C serial data bus
- AC OK & DC OK signal
- Internal ORing diode
- 3 years warranty



■ SELECTION GUIDE

Single Unit: RCP-1000-**12**-**C**

Rack: RCP-1U **I**

Whole System: RCP-3K1U **I**-**12**-**C**

C: With I²C Interface
-: Without I²C Interface

Output Voltage

I: AC Inlet(IEC320-C14)
T: Terminal Block

C: With I²C Interface
-: Without I²C Interface

Output Voltage

I: AC Inlet(IEC320-C14)
T: Terminal Block

SPECIFICATION - Single Unit

MODEL		RCP-1000-12	RCP-1000-24	RCP-1000-48	
OUTPUT	DC VOLTAGE	12V	24V	48V	
	RATED CURRENT	60A	40A	21A	
	CURRENT RANGE	0 ~ 60A	0 ~ 40A	0 ~ 21A	
	RATED POWER	720W	960W	1008W	
	RIPPLE & NOISE (max.) Note.2	150mVp-p	200mVp-p	300mVp-p	
	VOLTAGE ADJ. RANGE	11.6 ~ 12.4V	23.2 ~ 24.8V	46.3 ~ 49.7V	
	VOLTAGE TOLERANCE Note.3	±1.0%	±1.0%	±1.0%	
	LINE REGULATION	±0.5%	±0.5%	±0.5%	
	LOAD REGULATION	±0.5%	±0.5%	±0.5%	
	SETUP, RISE TIME	1000ms, 60ms/230VAC at full load			
HOLD UP TIME (Typ.)	16ms/230VAC at full load				
INPUT	VOLTAGE RANGE Note.5	90 ~ 264VAC	127 ~ 370VDC		
	FREQUENCY RANGE	47 ~ 63Hz			
	EFFICIENCY (Typ.)	81%	87%	89%	
	AC CURRENT (Typ.)	8.5A/115VAC	4.5A/230VAC	10.5A/115VAC	5.5A/230VAC
	INRUSH CURRENT (Typ.)	COLD START 50A			
LEAKAGE CURRENT	<1.1mA / 230VAC				
PROTECTION	OVERLOAD	105 ~ 125% rated output power Protection type : Constant current limiting, recovers automatically after fault condition is removed			
	OVER VOLTAGE	13.2 ~ 16.2V	26.4 ~ 32.4V	52.8 ~ 64.8V	
		Protection type : Shut down o/p voltage, re-power on to recover			
	OVER TEMPERATURE	75°C ±5°C (TSW1) detect on heatsink of power transistor 85°C ±5°C (TSW2) detect on heatsink of power diode Protection type : Shut down o/p voltage, recovers automatically after temperature goes down			

MODEL		RCP-1000-12	RCP-1000-24	RCP-1000-48
FUNCTION	AUXILIARY POWER	5V @ 0.3A		
	REMOTE ON/OFF CONTROL	By electrical signal or dry contact ON:short OFF:open		
	REMOTE SENSE	Compensate voltage drop on the load wiring up to 0.5V		
	DC OK SIGNAL	Open collector signal, on when $V_{out} \geq 80\% \pm 5\%$, max. sink current:10mA		
	AC FAIL SIGNAL	Open collector signal, refer to function manual		
	OUTPUT VOLTAGE TRIM	Adjustment of output voltage, possible between 90 ~ 110% of rated output		
	OVER TEMP WARNING	Logic "High" for over temperature warning, refer to function manual		
ENVIRONMENT	WORKING TEMP.	-20 ~ +60°C (Refer to output load derating curve)		
	WORKING HUMIDITY	20 ~ 90% RH non-condensing		
	STORAGE TEMP., HUMIDITY	-40 ~ +85°C, 10 ~ 95% RH		
	TEMP. COEFFICIENT	$\pm 0.02\%/^{\circ}\text{C}$ (0 ~ 50°C)		
	VIBRATION	10 ~ 500Hz, 2G 10min./1cycle, 60min. each along X, Y, Z axes		
SAFETY & EMC (Note 4)	SAFETY STANDARDS	UL60950-1, TUV EN60950-1 approved		
	WITHSTAND VOLTAGE	I/P-O/P:3KVAC I/P-FG:1.5KVAC O/P-FG:0.7KVDC		
	ISOLATION RESISTANCE	I/P-O/P, I/P-FG, O/P-FG:100M Ohms/500VDC		
	EMI CONDUCTION & RADIATION	Compliance to EN55022 (CISPR22) Class B		
	HARMONIC CURRENT	Compliance to EN61000-3-2,-3		
	EMS IMMUNITY	Compliance to EN61000-4-2,3,4,5,6,8,11, ENV50204, EN61000-6-2 (EN50082-2), heavy industry level, criteria A		
OTHERS	MTBF	43.4Khrs min. MIL-HDBK-217F (25°C)		
	DIMENSION	295*127*41mm (L*W*H)		
	PACKING	1.91Kg; 6pcs/12.5Kg/1.04CUFT		

SPECIFICATION - Rack System

MODEL		RCP-3K1U□-12	RCP-3K1U□-24	RCP-3K1U□-48
OUTPUT	MODULE	RCP-1000-12	RCP-1000-24	RCP-1000-48
	RACK	RCP-1UI or RCP-1UT		
	OUTPUT VOLTAGE	12V	24V	48V
	MAX. OUTPUT CURRENT	180A	120A	63A
	MAX. OUTPUT POWER <small>Note.6</small>	2160W	2880W	3024W
INPUT	VOLTAGE RANGE <small>Note.5</small>	90 ~ 264VAC 127 ~ 370VDC		
	FREQUENCY RANGE	47 ~ 63Hz		
	AC CURRENT (Typ.)FOR EACH UNIT	8.5A/115VAC 4.5A/230VAC	10.5A/115VAC 5.5A/230VAC	11A/115VAC 5.5A/230VAC
	LEAKAGE CURRENT	<3.5mA / 230VAC		
FUNCTION	AUXILIARY POWER	5V @ 0.3A		
	REMOTE ON/OFF CONTROL	By electrical signal or dry contact ON:short OFF:open		
	REMOTE SENSE	Compensate voltage drop on the load wiring up to 0.5V. "Local Sense" should be connected in order to get the correct output voltage if the "Remote Sense" is not used		
	DC OK SIGNAL	The TTL signal out, refer to function manual		
	AC FAIL SIGNAL	The TTL signal out, refer to function manual		
	OUTPUT VOLTAGE TRIM	Adjustment of output voltage, possible between 90 ~ 110% of rated output		
	OVER TEMP WARNING	Logic "High" for over temperature warning, refer to function manual		
ENVIRONMENT	WORKING TEMP.	-20 ~ +60°C (Refer to output load derating curve)		
	WORKING HUMIDITY	20 ~ 90% RH non-condensing		
	STORAGE TEMP., HUMIDITY	-40 ~ +85°C, 10 ~ 95% RH		
	TEMP. COEFFICIENT	$\pm 0.02\%/^{\circ}\text{C}$ (0 ~ 50°C)		
	VIBRATION	10 ~ 500Hz, 2G 10min./1cycle, 60min. each along X, Y, Z axes		
SAFETY & EMC (Note 4)	SAFETY STANDARDS	UL60950-1, TUV EN60950-1 approved		
	WITHSTAND VOLTAGE	I/P-O/P:3KVAC I/P-FG:1.5KVAC O/P-FG:0.7KVDC		
	ISOLATION RESISTANCE	I/P-O/P, I/P-FG, O/P-FG:100M Ohms/500VDC		
	EMI CONDUCTION & RADIATION	Compliance to EN55022 (CISPR22) Class B		
	HARMONIC CURRENT	Compliance to EN61000-3-2,-3		
	EMS IMMUNITY	Compliance to EN61000-4-2,3,4,5,6,8,11, ENV50204, EN61000-6-2 (EN50082-2), heavy industry level, criteria A		
OTHERS	DIMENSION	Rack 483.6*350.8*44(L*W*H)		
	PACKING	11Kg; 1pcs/11Kg/2.67CUFT		
NOTE	<ol style="list-style-type: none"> All parameters NOT specially mentioned are measured at 230VAC input, rated load and 25°C of ambient temperature. Ripple & noise are measured at 20MHz of bandwidth by using a 12" twisted pair-wire terminated with a 0.1uF & 47uF parallel capacitor. Tolerance : includes set up tolerance, line regulation and load regulation. The power supply is considered a component which will be installed into a final equipment. The final equipment must be re-confirmed that it still meets EMC directives. Derating may be needed under low input voltages. Please check the derating curve for more details. Output of all the RCP-1000 modules are connected in parallel in the rack. Under parallel operation of more than one rack connecting together, ripple of the output voltage may be higher than the SPEC at light load condition. It will go back to normal ripple level once the output load is more than 10%. 			

■ Mechanical Specification (Single Unit)

Case No. 952A Unit:mm

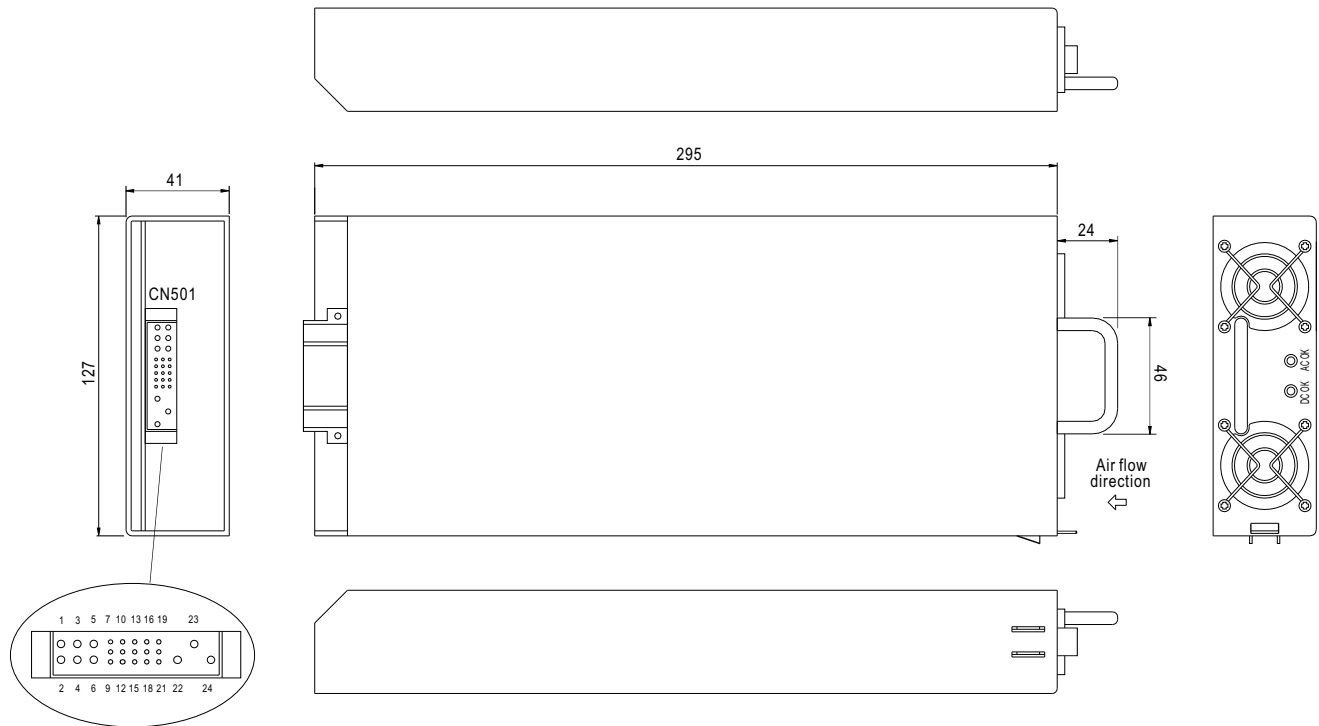

Input / Output Connector Pin No. Assignment(CN501) : Postronic PCB24W9M400A1

Pin No.	Assignment	Pin No.	Assignment	Pin No.	Assignment	Pin No.	Assignment	Mating Housing
1,2,4	+V	10	AC_OK	15	+5V_AUX	20	A1	Postronic PCB24W9F400A1
3,5,6	-V	11	DC_OK	16	GND_AUX	21	A2	
7	ON/OFF	12	CS	17	SDA	22	FG	
8	+S	13	V_TRIM	18	SCL	23	AC/L	
9	-S	14	T_ALARM	19	A0	24	AC/N	

■ Block Diagram

PFC fosc : 110KHz
PWM fosc : 90KHz

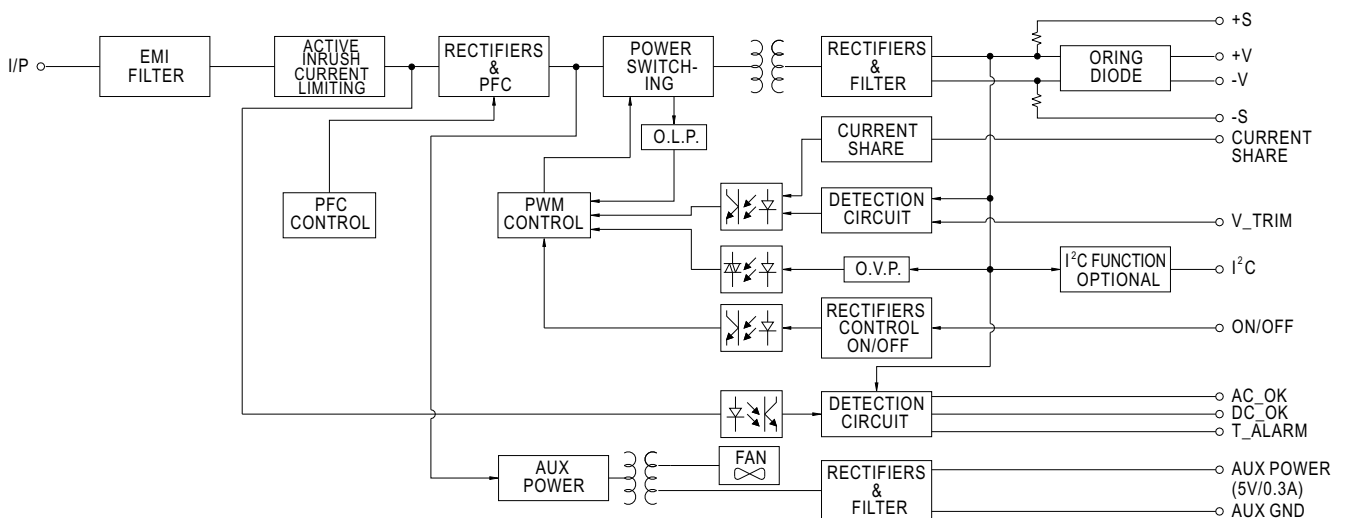

■ Mechanical Specification (Rack System)

Case No. 959A Unit:mm

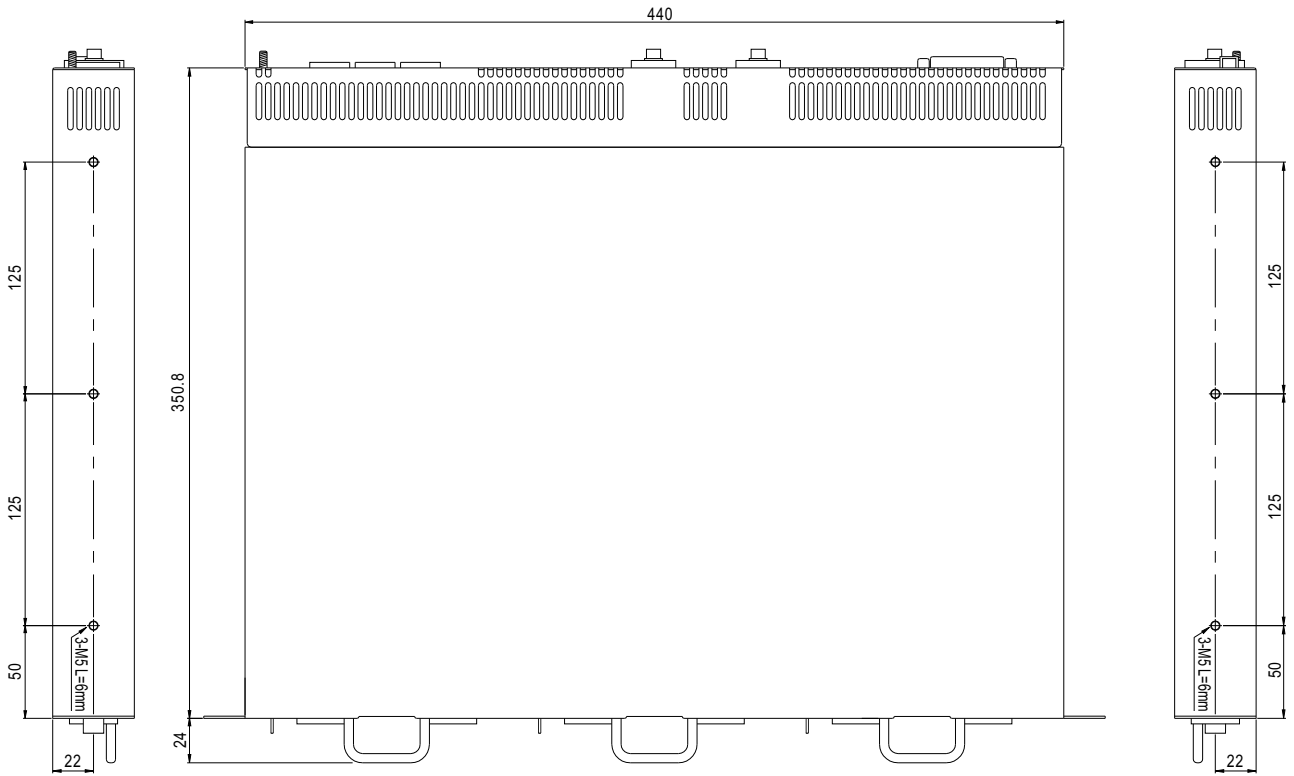
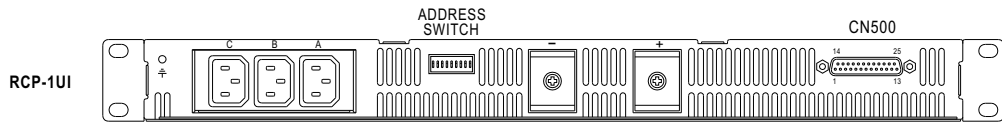
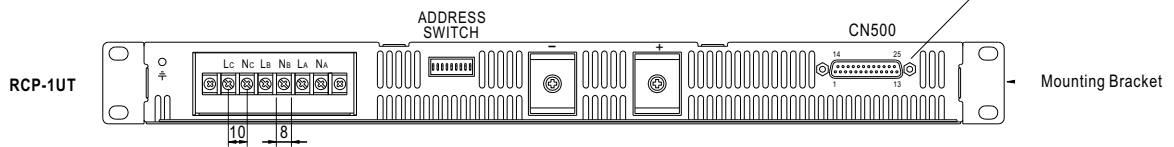
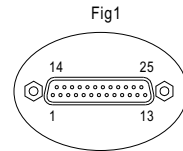
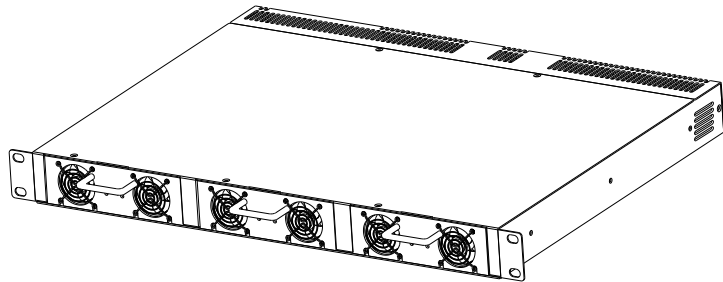

↑ Air flow direction

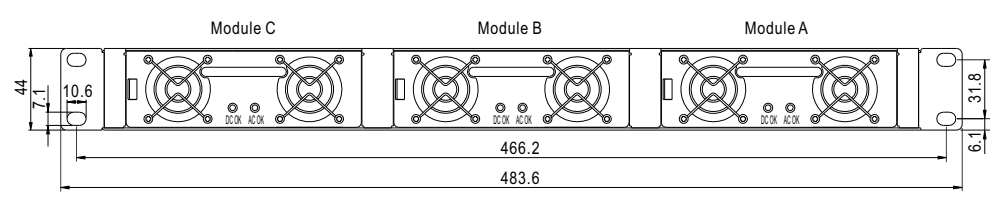

■ CN500 Pin No. Assignment

Connector Pin No. Assignment(CN500) : D-Type Right Angle 25 positions

Pin No.	Assignment	Pin No.	Assignment	Pin No.	Assignment	Pin No.	Assignment	Pin No.	Assignment
1	ON/OFF-A	6	+5V-AUX	11	V-TRIM-B	16	AC-OK-C	21	-S
2	AC-OK-A	7	GND-AUX	12	T-ALARM-B	17	DC-OK-C	22	+V
3	DC-OK-A	8	ON/OFF-B	13	NC	18	V-TRIM-C	23	SCL
4	V-TRIM-A	9	AC-OK-B	14	CS	19	T-ALARM-C	24	SDA
5	T-ALARM-A	10	DC-OK-B	15	ON/OFF-C	20	+S	25	-V

■ CN500 IN/OUT Connector pins function description

Pin No.	Function	Description
1, 8, 15	ON/OFF	Each unit can separately turn the output on and off by electrical or dry contact between ON/OFF A,B,C(pin 1,8,15) and -S(pin 21). Short: ON, Open:OFF.
2, 9, 16	AC-OK	Low : When the input voltage is $\geq 82Vrms \pm 4V$. High : when the input voltage in $\leq 82Vrms \pm 4V$.
3, 10, 17	DC-OK	High : When the Vout $\leq 80\% \pm 5\%$. Low : When Vout $\geq 80\% \pm 5\%$
4, 11, 18	V-TRIM	Connection for output voltage trimming. The voltage can be trimmed within its defined range.
5, 12, 19	T-ALARM	High : When the internal temperature is within safe limit. Low : 10°C below the thermal shut down limit.
6	+5V-AUX	Auxiliary voltage output, 4.3~5.3V, referenced to GND-AUX(pin 7). The maximum load current is 0.3A. This output has the built-in "Oring diodes" and is not controlled by the remote ON/OFF control.
7	GND-AUX	Auxiliary voltage output GND. The signal return is isolated from the output terminals (+V & -V).
14	CS	Current sharing signal. When units are connected in parallel, the CS pins of the units should be connected to allow current balance between units.
20	+S	Positive sensing. The +S signal should be connected to the positive terminal of the load. The +S and -S leads should be twisted in pair to minimize noise pick-up effect. The maximum line drop compensation is 0.5V.
21	-S	Negative sensing. The -S signal should be connected to the negative terminal of the load. The -S and +S leads should be twisted in pair to minimize noise pick-up effect. The maximum line drop compensation is 0.5V.
22	+V	Positive output voltage. For local sense use only, can't be connected directly to the load.
23	SCL	Serial clock used in the I ² C interface option. Refer to the I ² C interface description.
24	SDA	Serial data used in the I ² C interface option. Refer to the I ² C interface description.
25	-V	Negative output voltage. For local sense use only, can't be connected directly to the load.

■ Derating Curve

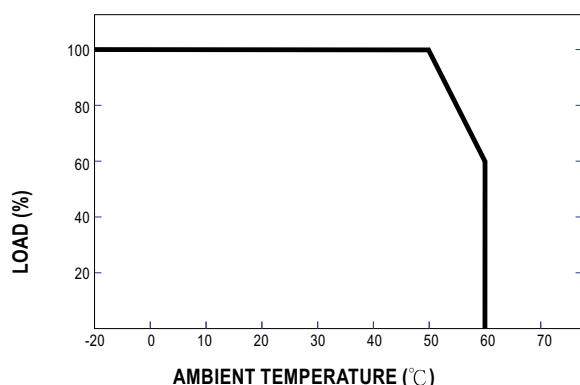

■ Static Characteristics

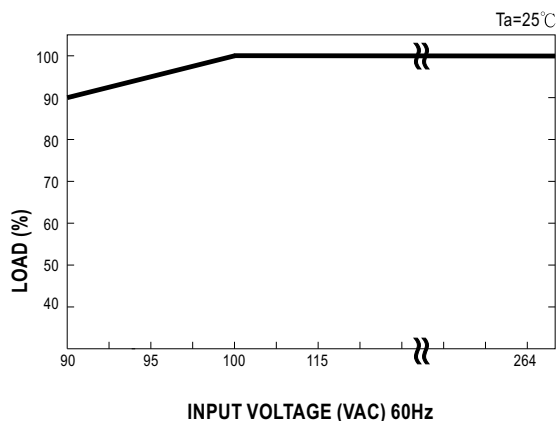

Function Manual

1. Remote ON/OFF Control

The PSU can be turned ON/OFF together or separately by using the "Remote ON/OFF" function.

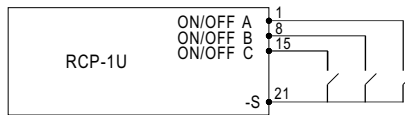
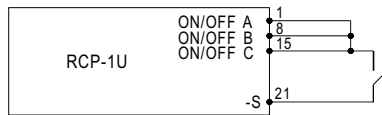

Between ON/OFF and -S	Output
SW Open	OFF
SW Short	ON

2. Voltage Drop Compensation

2.1 Remote Sense

The remote sense compensates voltage drop on the load wiring up to 0.5V.

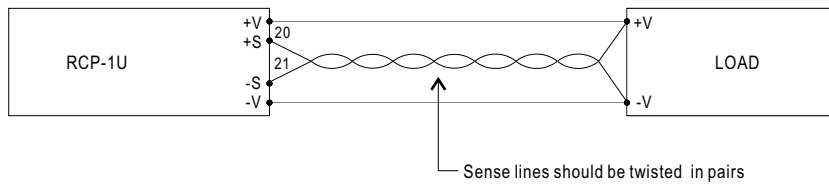

2.2 Local Sense

Notice : The +S,-S have to be connected to the +V,-V terminals locally in order to get the correct output voltage if the remote sensing is not used.



3. Output Voltage Trimming

Output voltage can be trimmed between 90~110% of its rated value by the following method.

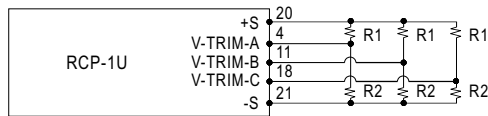

3.1 RCP-1000-12

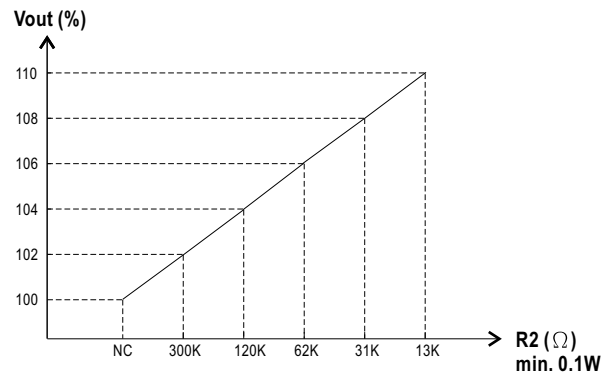
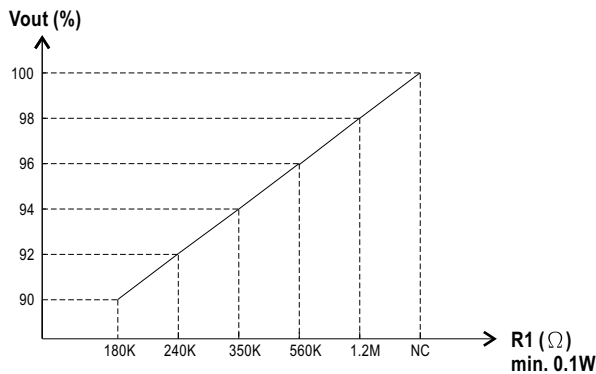

3.2 RCP-1000-24

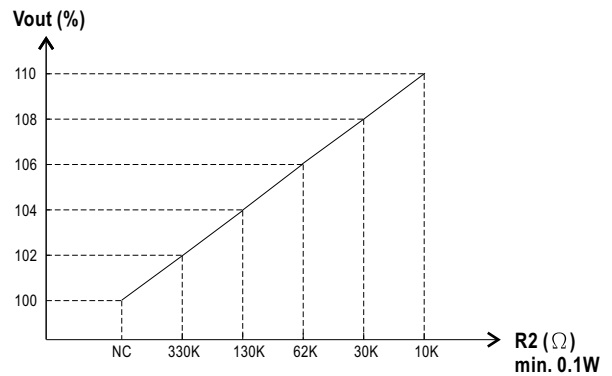
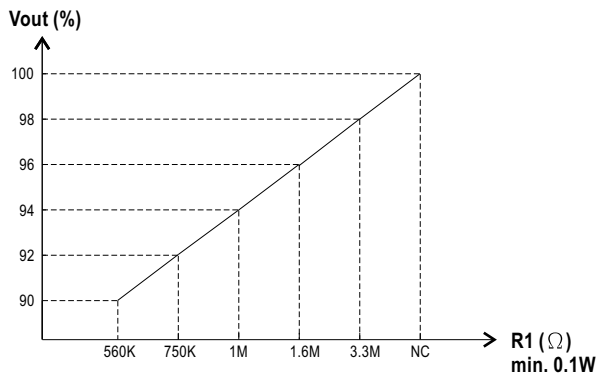

3.3 RCP-1000-48

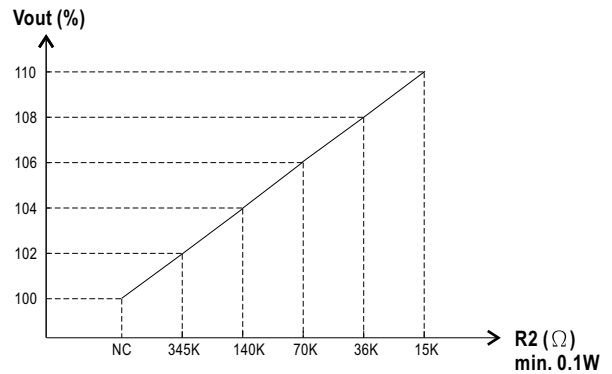
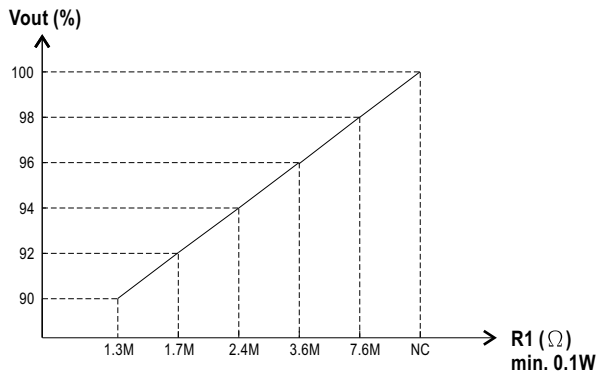

4. Front Panel Indicators & Corresponding Signal at Function Pins

Function	LED	Description	* Signal	PSU Output
AC-OK	ON	When input voltage $\geq 82V \pm 4V$	0 ~ 0.5V	ON
AC-NG	OFF	When input voltage $\leq 82V \pm 4V$	4.5 ~ 5.5V	OFF
DC-OK	ON	When output voltage $\geq 80\% \pm 5\%$ of V_o rated.	0 ~ 0.5V	ON
DC-NG	OFF	When output voltage $\leq 80\% \pm 5\%$ of V_o rated.	4.5 ~ 5.5V	ON
T-OK	----	When the internal temperature (TSW1 & TSW2 short) is within safe limit	0 ~ 0.5V	ON
T-ALARM	----	When the internal temperature (TSW1 or TSW2 open) exceeds the limit of temperature alarm	4.5 ~ 5.5V	OFF

*Signal between function pin and "-S".

5. I²C Bus Interface Option

5.1 Addressing(A0,A1,A2)

The DIP switch down position is logic level "1" and the up position is level "0". Address are applicable when modules RCP-1000 I²C function are used.

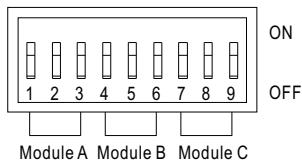

Address dip switch setting

A2	A1	A0	Module
3	2	1	A
6	5	4	B
9	8	7	C

MODEL : RCP-1000-24

OUTPUT FUNCTION TEST

NO	TEST ITEM	SPECICATION	TEST CONDITION	RESULT	VERDICT
1	RIPPLE & NOISE	V1: 200 mVp-p (Max)	I/P: 230VAC O/P:FULL LOAD Ta:25°C	V1: 38 mVp-p (Max)	P
2	OUTPUT VOLTAGE ADJUST RANGE	CH1: 23.2 V~ 24.8 V	I/P: 230 VAC I/P: 115 VAC O/P:MIN LOAD Ta:25°C	22.92 V~ 25.52 V/ 230 VAC 22.92 V~ 25.52 V/ 115 VAC	P
3	OUTPUT VOLTAGE TOLERANCE	V1: 1 %- -1 % (Max)	I/P: 100 VAC / 264 VAC O/P:FULL/ MIN LOAD Ta:25°C	V1: 0.05 %- -0.05 %	P
4	LINE REGULATION	V1: 0.5 %- -0.5 % (Max)	I/P: 100VAC ~ 264 VAC O/P:FULL LOAD Ta:25°C	V1: 0.03 %- -0.03 %	P
5	LOAD REGULATION	V1: 0.5 %- -0.5 % (Max)	I/P: 230 VAC O/P:FULL ~MIN LOAD Ta:25°C	V1: 0.05 %- -0.05 %	P
6	SET UP TIME	230VAC: 1000 ms (Max)	I/P: 230 VAC O/P:FULL LOAD Ta:25°C	230VAC/ 81 ms	P
7	RISE TIME	230VAC: 60 ms (Max)	I/P: 230 VAC O/P:FULL LOAD Ta:25°C	230VAC/ 29 ms	P
8	HOLD UP TIME	230VAC: 16 ms (TYP)	I/P: 230 VAC O/P:FULL LOAD Ta:25°C	230VAC/ 18.9 ms	P
9	OVER/UNDERSHOOT TEST	< ±5%	I/P: 230 VAC O/P:FULL LOAD Ta:25°C	TEST: <5 %	P
10	DYNAMIC LOAD	V1: 2400 mVp-p	I/P: 230 VAC O/P:FULL /Min LOAD 90%DUTY/1KHZ Ta:25°C	584 mVp-p	P

INPUT FUNCTION TEST

NO	TEST ITEM	SPECICATION	TEST CONDITION	RESULT	VERDICT
1	INPUT VOLTAGE RANGE	90VAC~264 VAC	I/P:TESTING O/P:FULL LOAD Ta:25°C	83V~264V	P
			I/P: LOW-LINE-3V= 87V HIGH-LINE+15%=300 V O/P:FULL/MIN LOAD ON: 30 Sec . OFF: 30 Sec 10MIN (AC POWER ON/OFF NO DAMAGE)	TEST: OK	
2	INPUT FREQUENCY RANGE	47HZ ~63 HZ NO DAMAGE OSC	I/P: 90 VAC ~ 264 VAC O/P:FULL~MIN LOAD Ta:25°C	TEST: OK	P
3	POWER FACTOR	0.96 / 230 VAC(TYP)	I/P: 230 VAC I/P: 115 VAC O/P:FULL LOAD Ta:25°C	PF= 0.973 / 230 VAC	P
		0.96 / 115 VAC(TYP)		PF= 0.998 / 115 VAC	
4	EFFICIENCY	87 % (TYP)	I/P: 230 VAC O/P:FULL LOAD Ta:25°C	87.4%	P
5	INPUT CURRENT	230V/ 5.5 A (TYP)	I/P: 230 VAC I/P: 115 VAC O/P:FULL LOAD Ta:25°C	I = 4.9 A/ 230 VAC	P
		115V/ 10.5 A (TYP)		I = 10.1 A/ 115 VAC	
6	INRUSH CURRENT	230V/ 50 A (TYP)	I/P: 230 VAC O/P:FULL LOAD Ta:25°C	I = 45 A/ 230 VAC	P
		COLD START			
7	LEAKAGE CURRENT	< 1.1 mA / 230 VAC	I/P: 264 VAC (SINGLE UNIT) O/P:Min LOAD Ta:25°C	L-FG: 0.85 mA N-FG: 0.85 mA	P
		< 3.5 mA / 230 VAC		I/P: 264 VAC (RACK SYSTEM) O/P:Min LOAD Ta:25°C	

PROTECTION FUNCTION TEST

NO	TEST ITEM	SPECICATION	TEST CONDITION	RESULT	VERDICT
1	OVER LOAD PROTECTION	105 %- 125 %	I/P: 230 VAC I/P: 115 VAC O/P:TESTING Ta:25°C	120%/ 230 VAC 120%/ 115 VAC Constant Current Limiting	P
2	OVER VOLTAGE PROTECTION	CH1: 26.4 V~ 32.4 V	I/P: 230 VAC I/P: 115 VAC O/P:MIN LOAD Ta:25°C	29.5 V/ 230 VAC 29.5 V/ 115 VAC Shunt down Re- power ON	P
3	OVER TEMPERATURE PROTECTION	SPEC: TSW1: 75 ± 5°C O.T.P. TSW2: 85 ± 5°C O.T.P. NO DAMAGE	I/P: 230 VAC O/P:FULL LOAD	O.T.P. Active Shut down o/p voltage , recovers automatically after temperature goes down	P
4	SHORT PROTECTION	SHORT EVERY OUTPUT 1 HOUR NO DAMAGE	I/P: 264 VAC O/P:FULL LOAD Ta:25°C	NO DAMAGE Constant Current Limiting	P

CONTROL FUNCTION TEST

NO	TEST ITEM	SPECICATION	TEST CONDITION	RESULT	VERDICT
1	FAN LOCK TEST	FAN LOCK :POWER OFF FAN UNLOCK :POWER ON	I/P: 230 VAC O/P:FULL LOAD	FAN LOCK :POWER OFF FAN UNLOCK :POWER ON	P
2	FAN SPEED CONTROL	Fan Voltage : NO LOAD:8.7V \pm 1V 100% LOAD:11.8V \pm 0.6V	I/P: 230 VAC O/P:TESTING Ta:25°C	Fan Voltage: NO LOAD: 8.16 V 100% LOAD: 11.8 V	P
3	REMOTE ON/OFF	ON/OFF--S SHORT : POWER ON ON/OFF--S OPEN : POWER OFF that is shown in Function Manual 1.1 (SPEC)	I/P: 230 VAC O/P:FULL LOAD Ta:25°C	ON/OFF& -S SHORT : POWER ON ON/OFF& -S OPEN : POWER OFF	P
4	AC OK Signal	Sink current 10 mA 1. When Input voltage \geq 82V \pm 4V: AC_OK --S : 0-0.5V Output ON/LED ON 2. When input voltage \leq 82V \pm 4V: AC_OK --S : 4.5-5.5V Output OFF / LED OFF that is shown in Function Manual 4.1 (SPEC)	I/P: TESTING O/P:FULL LOAD Ta:25°C	1. Input voltage \geq 84V : AC_OK --S : 0V LED ON / PSU Output ON 2. Input voltage \leq 82V : AC_OK --S : 5.02 V LED OFF / PSU Output OFF	P
5	DC OK Signal	Sink current 10 mA 1. When output voltage \geq 80% \pm 5%: DC_OK --S : 0-0.5V Output ON / LED ON 2. When output voltage \leq 80% \pm 5%: DC_OK --S : 4.5-5.5V Output OFF / LED ON that is shown in Function Manual 4.1 (SPEC)	I/P: 230 VAC O/P:FULL LOAD Ta:25°C	1. Output voltage \geq 80 %: DC_OK --S : 0V LED ON / PSU Output ON 2. Output voltage \leq 79%: DC_OK --S : 4.95 V LED OFF / PSU Output ON	P
6	REMOTE SENSE	>0.5V that is shown in Function Manual 2.1 (SPEC)	I/P: 230 VAC O/P:FULL LOAD Ta:25°C	>0.5V	P
7	Output voltage TRIM	Adjustment of output voltage is possible between 90 %-110 % of rated output Connecting a resistor externally that is shown in Function Manual 3.2 (SPEC)	I/P: 230 VAC O/P:FULL LOAD Ta:25°C	External Resistor 90% Voltage= 510 K Ω 110% Voltage= 14 K Ω	P
8	OVER TEMP ALARM	1.T-OK : When the TSW1 and TSW2 short : T-ALARM --S : 0-0.5V Output ON 2. T-ALARM: When the TSW1 or TSW2 open : T-ALARM --S : 4.5V-5.5V Output OFF that is shown in Function Manual 4.1 (SPEC)	I/P: 230 VAC O/P:FULL LOAD Ta:25°C	1. T-ALARM --S : 0 V PSU Output ON 2. T-ALARM --S : 5.01 V PSU Output OFF	P
9	AUX ILIRY POWER (AUX)	5V @ 0.3A (4.5V-5.3V)	I/P: 230 VAC O/P:FULL LOAD Ta:25°C	5.01V	P

ENVIRONMENT TEST

NO	TEST ITEM	SPECICATION	TEST CONDITION	RESULT	VERDICT
1	TEMPERATURE RISE TEST	MODEL : RCP-1000-24 1. ROOM AMBIENT BURN-IN : 1.5HRS I/P: 230VAC O/P: FULL LOAD Ta= 36.5℃ 2. HIGH AMBIENT BURN-IN : 3HRS I/P: 230VAC O/P: FULL LOAD Ta= 53.7℃			P
2	OVER LOAD BURN-IN TEST	NO DAMAGE 1 HOUR (MIN)	I/P: 230 VAC O/P: 118% LOAD Ta:25℃	TEST : OK	P
3	LOW TEMPERATURE TURN ON TEST	TURN ON AFTER 2 HOUR	I/P: 230 VAC O/P: 100% LOAD Ta= -20℃	TEST : OK	P
4	HIGH HUMIDITY HIGH TEMPERATURE HIGH VOLTAGE TURN ON TEST	AFTER 12 HOURS IN CHAMBER ON CONTROL 50 ℃ NO DAMAGE	I/P: 272 VAC O/P:FULL LOAD Ta= 50℃ HUMIDITY= 95 %R.H	TEST : OK	P
5	TEMPERATURE COEFFICIENT	± 0.02 %(0-50℃)	I/P: 230 VAC O/P:FULL LOAD	± 0.003 %(0-50℃)	P
6	VIBRATION TEST	1 Carton & 1 Set (1) Waveform: Sine Wave (2) Frequency:10-500Hz (3) Sweep Time:10min/sweep cycle (4) Acceleration:2G (5) Test Time:1 hour in each axis (X.Y.Z) (6) Ta:25℃		TEST : OK	P

SAFETY TEST

NO	TEST ITEM	SPECICATION	TEST CONDITION	RESULT	VERDICT
1	WITHSTAND VOLTAGE	I/P-O/P: 3 KVAC/min I/P-FG: 1.5 KVAC/min O/P-FG: 0.7 KVDC/min	I/P-O/P: 3.6 KVAC/min I/P-FG: 1.8 KVAC/min O/P-FG: 0.84 KVDC/min Ta:25°C	I/P-O/P: 12.27 mA I/P-FG: 8.53 mA O/P-FG: 0.002 mA NO DAMAGE	P
2	ISOLATION RESISTANCE	I/P-O/P:500VDC>100MΩ I/P-FG: 500VDC>100MΩ O/P-FG:500VDC>100MΩ	I/P-O/P: 500 VDC I/P-FG: 500 VDC O/P-FG: 500 VDC Ta:25°C	I/P-O/P: 30 GΩ I/P-FG: 30 GΩ O/P-FG: 5 GΩ NO DAMAGE	P
3	GROUNDING CONTINUITY	FG(PE) TO CHASSIS OR TRACE < 100 mΩ	40 A / 2min Ta:25°C	7 mΩ	P
4	APPROVAL	TUV: Certificate NO : R50094068 UL: File NO : E183223			P

E.M.C TEST

NO	TEST ITEM	SPECICATION	TEST CONDITION	RESULT	VERDICT
1	HARMONIC	EN61000-3-2 CLASS D	I/P: 230 VAC/50HZ O/P:FULL LOAD Ta:25°C	PASS	P
2	CONDUCTION	EN55022 CLASS B	I/P: 230 VAC (50HZ) O/P:FULL/50% LOAD Ta:25°C	PASS Test by certified Lab	P
3	RADIATION	EN55022 CLASS B	I/P: 230 VAC (50HZ) O/P:FULL LOAD Ta:25°C	PASS Test by certified Lab	P
4	E.S.D	EN61000-4-2 INDUSTRY AIR:8KV / Contact:4KV	I/P: 230 VAC/50HZ O/P:FULL LOAD Ta:25°C	CRITERIA A	P
5	E.F.T	EN61000-4-4 INDUSTRY INPUT: 2KV	I/P: 230 VAC/50HZ O/P:FULL LOAD Ta:25°C	CRITERIA A	P
6	SURGE	IEC61000-4-5 INDUSTRY L-N :2KV L,N-PE:4KV	I/P: 230 VAC/50HZ O/P:FULL LOAD Ta:25°C	CRITERIA A	P
7	Test by certified Lab & Test Report Prepare				

M.T.B.F & LIFE CYCLE CALCULATION

NO	TEST ITEM	SPECICATION	TEST CONDITION	RESULT	VERDICT
1	CAPACITOR LIFE CYCLE	RCP-1000-24 : SUPPOSE C110 IS THE MOST CRITICAL COMPONENT I/P: 230VAC O/P:FULL LOAD Ta= 25 °C LIFE TIME= 777098 HRS I/P: 230VAC O/P:FULL LOAD Ta= 50 °C LIFE TIME= 176323 HRS			P
2	MTBF	MIL-HDBK-217F NOTICES2 PARTS COUNT TOTAL FAILURE RATE: 43.4K HRS			P

COMPONENT STRESS TEST

NO	TEST ITEM	SPECICATION	TEST CONDITION	RESULT	VERDICT
1	Power Transistor (D to S) or (C to E) Peak Voltage	Q900 Rated 2SK2082 : 900 V 9A	I/P:High-Line +3V = 267 V O/P: (1)Full Load Turn on (2) Output Short Ta:25°C	(1) 870 V (2) 830 V	P
2	Diode Peak Voltage	D102 Rated S30JC10 : 100V 30A	I/P:High-Line +3V = 267 V O/P: (1)Full Load Turn on (2)Output Short Ta:25°C	(1) 83.5 V (2) 46 V	P
3	Clamp Diode Peak Voltage	D900 Rated BYM26E : 1KV 2.3 A	I/P:High-Line +3V = 267 V O/P: (1) Dynamic Load 90%Duty/1KHz Ta:25°C	(1) 830 V	P
4	Input Capacitor Voltage	C5 Rated : 220u / 450V/ 105°C	I/P:High-Line +3V = 267 V O/P: (1)Full Load Turn on /Off (2) Min load Turn on /Off (3)Full Load /Min load Change Ta:25°C	(1) 404 V (2) 396 V (3) 404 V	P
5	Control IC Voltage Test	U2 Rated UCC28220D : 15 V	I/P:High-Line +3V = 267 V O/P: (1)Full Load Turn on /Off (2) Min load Turn on /Off (3)Full Load /Min load Change Ta:25°C	(1) 14 V (2) 14 V (3) 14 V	P

DATE	SAMPLE	TEST RESULT	TESTER	APPROVAL
2006/9/8	RD SAMPLE	PASS	VINCENT TSENG	MAX LIN
2006/11/14	PRODUCT SAMPLE W0610A30	PASS	VINCENT TSENG	MAX LIN
2007/2/16	PRODUCT SAMPLE W0701B31	PASS	VINCENT TSENG	MAX LIN

2003/12/12 A50-F023