

# Breadboard Voltage Regulator v2.1

## Convenient 5V Supply for Breadboard

Turn your 6~18VDC "Wall Wart" adapter into a regulated 5VDC @ 0.5 Ampere supply for your breadboard experiments!

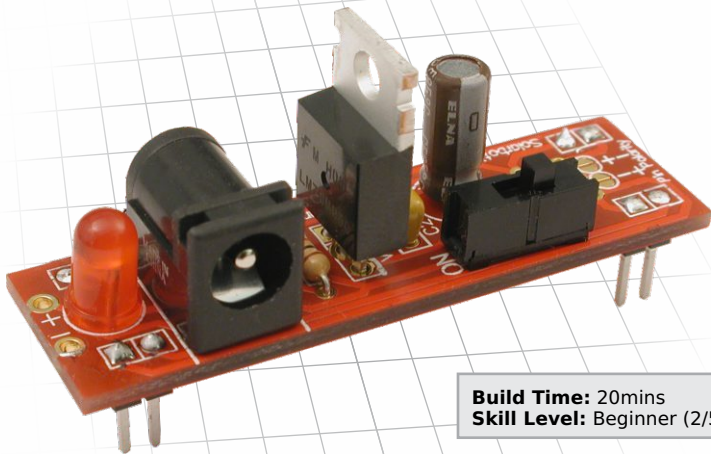

**Build Time:** 20mins  
**Skill Level:** Beginner (2/5)

- Power Switch
- LED Power Indicator
- Polarity Configurable
- Handy like you won't believe!



# SOLARBOTICS<sup>®</sup>

Ltd

[www.solarbotics.com](http://www.solarbotics.com)

1-866-276-2687

You'll find the BVRv2 to be a pretty handy addition to your workstation. It's an easy kit to build, but it is still a good idea to quick read through the instructions *just to make sure* you're building it right.

We strongly suggest you inventory the parts in your kit to make sure you have all the parts listed. If anything is missing, contact Solarbotics Ltd. for replacement parts information.

**Disclaimer of Liability - a.k.a. Legalese to make the lawyers happy**

Solarbotics Ltd. is not responsible for any special, incidental, or consequential damages resulting from any breach of warranty, or under any legal theory, including lost profits, downtime, good-will, damage to or replacement of equipment or property, and any costs or recovering of any material or goods associated with the assembly or use of this product. Solarbotics Ltd. reserves the right to make substitutions and changes to this product without prior notice. And to leave chocolate chip cookie crumbs on your couch.

## Parts List

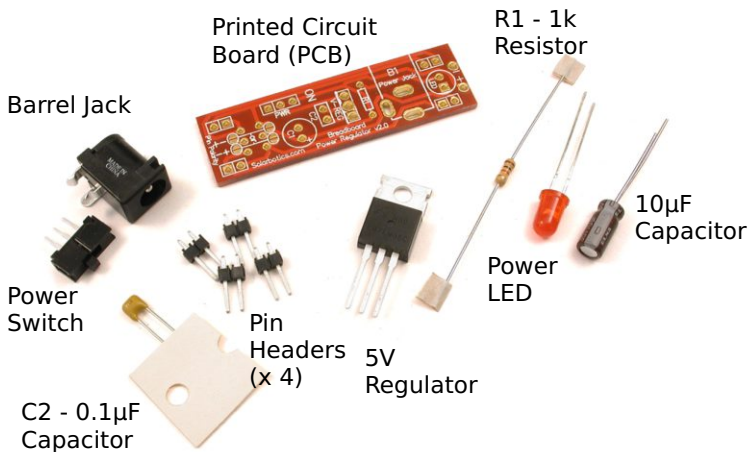

- 1 x Printed Circuit Board (v2.2 is a bit different from 2.1, but nothing strange enough to make assembly difficult)
- 1 x Power Switch
- 1 x 2.1mm DC Power Connector Barrel Jack
- 1 x C1 - 10 $\mu$ F Electrolytic Capacitor
- 1 x C2 - 0.1 $\mu$ F Monolithic Capacitor
- 1 x 5V Voltage Regulator
- 1 x 1k Resistor (Brown/Black/Red)
- 1 x Red Power Indicator LED
- 4 x Pin Headers

You will need a 6~18VDC power supply, with a 2.1mm tip-positive barrel jack. Look for this symbol:

# Construction

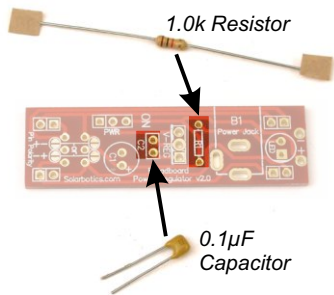

**1. Resistor & 0.1µF Capacitor:**  
Remove the tape, and bend the leads of the resistor over, and insert it into the position labeled 'R1'. Solder it in from the other side, and snip the excess leads.

Do the same for the 0.1µF capacitor into position 'C2'. It doesn't matter which way these parts are installed - they are polarity *insensitive*.

## 2. Voltage Regulator & Barrel Jack:

Solder the Voltage Regulator to the 'V-REG' position. Make sure the tab-side aligns with the fat line on the symbol. Backwards won't work! Then trim off the excess leads.

Snap the Barrel Jack into position 'B1' and solder it into place.

Finished Install

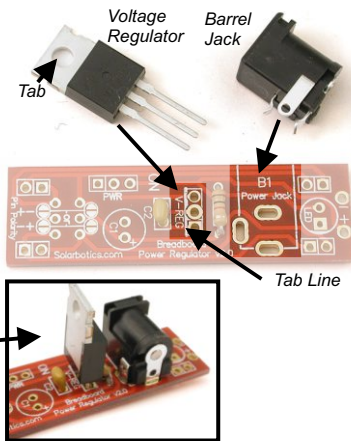

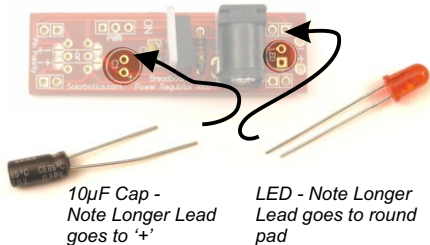

### 3. 10µF Capacitor & Power LED:

Install the 10µF electrolytic capacitor into position 'C1'. Position is critical (otherwise, \*poof\*). Make sure the longer lead goes into the pad marked (+). Confirm by checking that the

stripe on the side of the capacitor is nearest to the "PWR" label.

Similar plan with the LED - longer lead goes into the round pad. You can confirm by noting the little notch on the LED is on the side of the LED symbol with the line (near the square pad).

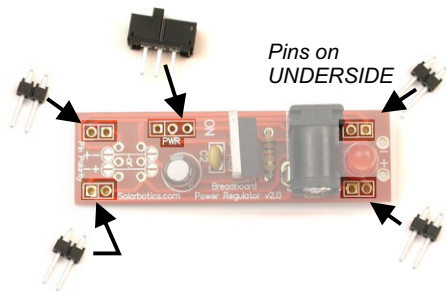

### 4. Power Switch & Breadboard Pins:

The Power Switch simply mounts into the position 'PWR'. Nothing difficult.

The breadboard pins are a bit more difficult, as they go on the underside, and are harder to hold while soldering. If you are confident, push the long side of the pins into your breadboard so they match the holes in the PCB, and solder them in while the breadboard holds everything in alignment. Otherwise, carefully solder them in as straight as you can by hand.

5. Configuring Power Rails:  
**THIS IS IMPORTANT** - Forget to do this, and your BVRv2 won't work!

Choose which side of the breadboard you want your BVRv2 to mount (here we use the left side). Note the polarity of the breadboard rails (+ on bottom, '-' on top).

Find which set of pads on the BVRv2 match this arrangement, and put a blob of solder across the little  $\frac{1}{2}$  moons.

If you plan to switch the polarity of the power on the rails (kinda *dangerous*), you can mount part number SWT7 on the pads between the blob pads. *Do not* put any blobs on the pads if you do this. This is generally not a recommended modification!

Power your BVRv2 with any DC power source rated 6~18 volts (35VDC max!). The power regulator will warm when powered with over 12V (that's ok).

If you don't want to use it on a breadboard, use the solder pads labeled "+ -" points on the end nearest the barrel jack for 5V regulated power output. Enjoy your BVR!

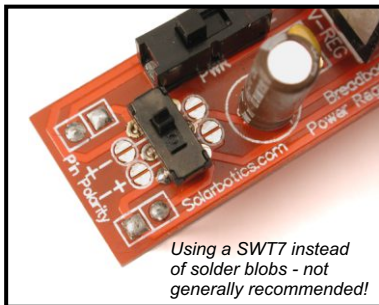
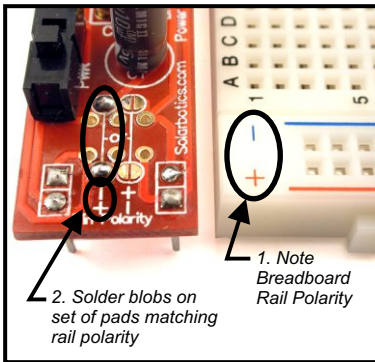

## Technical Support

Technical support is available if you are having problems - please contact us and provide as much detailed information as possible.

**E-mail:** [support@solarbotics.com](mailto:support@solarbotics.com)

**Phone:** (403) 730-8603

(Monday - Friday 9am – 5pm Mountain time)

### Get prototyping!

with other great products from Solarbotics:

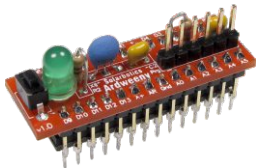

**Ardweeny:** It's a breadboard-friendly, *inexpensive* Arduino-clone. Add your own TTL-compatible programming cable, and get join the Arduino revolution!



**'AXE Stack-18:** This mounts on any breadboard for total prototyping flexibility of the PICAXE series of microcontrollers.

### Plus...

- Microcontrollers
- IR Sensors
- Compilers
- PIC Programmers
- Proto Boards
- FPGA Development Kits
- Robotics Kits/Part
- Instructional Books
- Gifts & Toys
- Tools and test equipment

# Fast and practical breadboard power

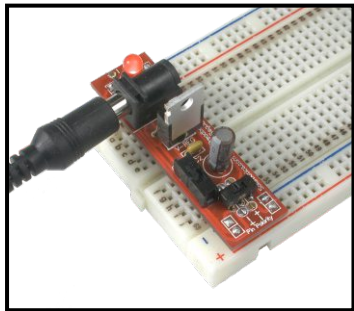

The BVR has been specially designed to mount onto the power rails of a standard breadboard and accepts any standard 2.1 mm barrel plug found on most AC adapters. This makes it ideal for many prototyping projects!

Visit us online for more info and cool stuff:

[www.solarbotics.com](http://www.solarbotics.com)

**Solarbotics Ltd.**  
3740D - 11A Street NE, Suite 101  
Calgary, Alberta T2E 6M6  
Canada



**Toll Free:** 1-866-276-2687  
**International:** +1 (403) 232-6268



**Fax:** +1 (403) 226-3741



Made in Canada