

# Metallized Polyester Film Capacitors

## MKT Radial Epoxy Lacquered Type

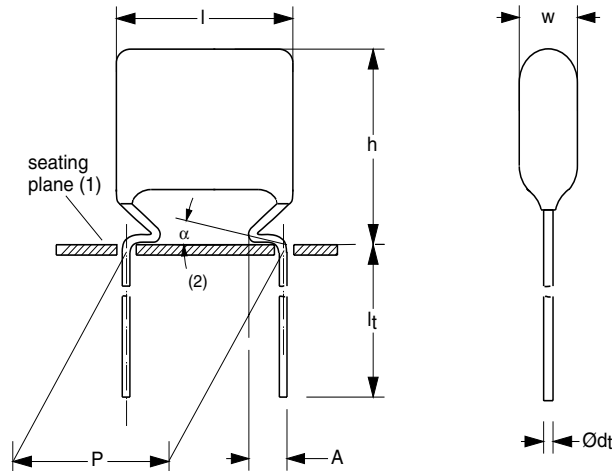

Dimensions in mm

- (1) Hole  $\varnothing$  1.0 for  $d_t = 0.6$  mm  
Hole  $\varnothing$  1.3 for  $d_t = 0.8$  mm
- (2)  $0 \leq \alpha < 50^\circ$
- (3)  $A = 2.0 + 1.0/-0.5$  mm (pitch = 10.0 mm)  
 $A = 2.5 + 1.4/-0.5$  mm (pitch = 15.0 mm, 22.5 mm and 27.5 mm)

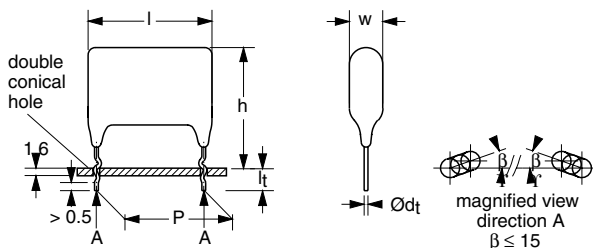

Dimensions in mm

### APPLICATIONS

Blocking and coupling. Bypass and energy reservoir

### MARKING

C-value; tolerance; rated voltage

### DIELECTRIC

Polyester film

### ELECTRODES

Vacuum deposited aluminium

### FEATURES

- Available taped on reel and loose in box
- Lead (Pb)-free product
- RoHS-compliant product



**RoHS**  
COMPLIANT

### COATING

Flame retardant epoxy material (UL-class 94 V-0)

### CONSTRUCTION

Wound mono construction

### LEADS

Tinned wire

### CAPACITANCE RANGE (E12 SERIES)

0.001 to 1.0  $\mu$ F

### CAPACITANCE TOLERANCE

$\pm 10\%$ ;  $\pm 5\%$

### RATED (DC) VOLTAGE

63 V; 100 V; 250 V; 400 V; 630 V

### RATED (AC) VOLTAGE

40 V; 63 V; 160 V; 220 V; 250 V

### CLIMATIC CATEGORY

55/105/56

### RATED TEMPERATURE

85 °C

### MAXIMUM APPLICATION TEMPERATURE

105 °C

### REFERENCE SPECIFICATIONS

IEC 60384-2

### PERFORMANCE GRADE

Grade 1 (long life)

### DETAIL SPECIFICATION

For more detailed data and test requirements see "Type detail specification HQN-384-02/101"



## COMPOSITION OF CATALOG NUMBER

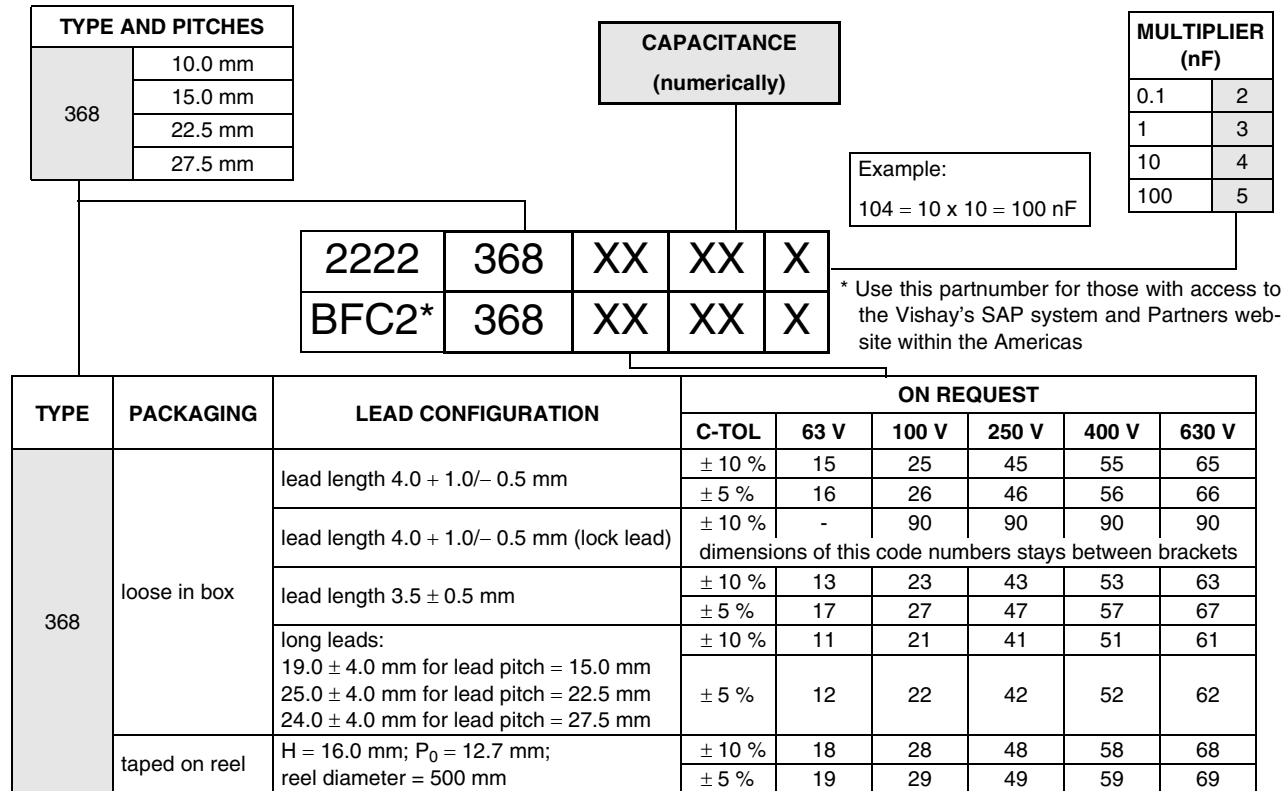

## SPECIFIC REFERENCE DATA

DESCRIPTION	VALUE				
	at 1 kHz		at 10 kHz	at 100 kHz	
Tangent of loss angle: C ≤ 0.1 μF 0.1 μF < C ≤ 0.47 μF 0.47 μF < C ≤ 1.0 μF	≤ 75 × 10 <sup>-4</sup>		≤ 130 × 10 <sup>-4</sup>	≤ 225 × 10 <sup>-4</sup>	
	≤ 75 × 10 <sup>-4</sup>		≤ 130 × 10 <sup>-4</sup>	≤ 300 × 10 <sup>-4</sup>	
	≤ 75 × 10 <sup>-4</sup>		≤ 130 × 10 <sup>-4</sup>	-	
Rated voltage pulse slope (dU/dt) <sub>R</sub> P = 10 mm P = 15 mm P = 22.5 mm P = 27.5 mm	at 63 V (DC) 30 V/μs	at 100 V (DC) 30 V/μs 20 V/μs 8 V/μs 7 V/μs	at 250 V (DC) 70 V/μs 28 V/μs 12 V/μs 10 V/μs	at 400 V (DC) 110 V/μs 44 V/μs 20 V/μs 16 V/μs	at 630 V (DC) 70 V/μs 70 V/μs 28 V/μs 24 V/μs
R between leads, for C ≤ 0.33 μF: at 10 V; 1 minute at 100 V; 1 minute at 500 V; 1 minute	> 15000 MΩ	> 15000 MΩ	> 30000 MΩ	> 30000 MΩ	> 30000 MΩ
RC between leads, for C > 0.33 μF: at 10 V; 1 minute at 100 V; 1 minute at 500 V; 1 minute	> 5000 s	> 5000 s	> 10000 s	> 10000 s	> 10000 s
R between interconnecting leads and casing; at 10 V; 1 minute at 100 V; 1 minute at 500 V; 1 minute	> 30000 MΩ	> 30000 MΩ	> 30000 MΩ	> 30000 MΩ	> 30000 MΩ
Withstanding (DC) voltage (cut off current 10 mA); rise time 100 V/s	100 V; 1 minute	160 V; 1 minute	400 V; 1 minute	640 V; 1 minute	1008 V; 1 minute
Withstanding (DC) voltage between leads and case	200 V; 1 minute	200 V; 1 minute	500 V; 1 minute	800 V; 1 minute	1260 V; 1 minute



Metallized Polyester Film Capacitors Vishay BCcomponents  
MKT Radial Epoxy Lacquered Type

**U<sub>Rdc</sub> = 63 V; U<sub>Rac</sub> = 40 V**

C ( $\mu$ F)	DIMENSIONS $w_{max} \times h_{max} \times l_{max}$ (mm)	MASS (g)	CATALOG NUMBER 2222 368 ..... AND PACKAGING					
			LOOSE IN BOX			REEL	LOOSE IN BOX	
			$l_t =$ 4.0 + 1.0/- 0.5 mm	short leads	long leads	SPQ	$l_t =$ 4.0 + 1.0/- 0.5 mm	SPQ
			C-tol = $\pm$ 10 %				C-tol = $\pm$ 10 %	
last 5 digits of catalog number	SPQ	SPQ	SPQ	last 5 digits of catalog number	SPQ			
<b>Pitch = 10.0 <math>\pm</math> 0.4 mm; <math>d_t</math> = 0.60 <math>\pm</math> 0.06 mm</b>							<b>lock lead</b>	
0.22	4.2 $\times$ 13.2 (15.5) $\times$ 12.5	0.5	15224	2000	1000	1300	90316	1100
0.27	4.0 $\times$ 12.8 (15.5) $\times$ 12.5	0.5	15274	2000	1000	1300	90317	1100
0.33	4.3 $\times$ 13.1 (15.5) $\times$ 12.5	0.5	15334	2000	1000	1300	90318	1100
0.39	4.2 $\times$ 12.9 (15.5) $\times$ 12.5	0.5	15394	2000	1000	1300	90319	1100
0.47	4.3 $\times$ 13.4 (16.0) $\times$ 12.5	0.5	15474	2000	1000	1200	90321	1000
0.56	4.7 $\times$ 13.7 (16.0) $\times$ 12.5	0.5	15564	2000	1000	1200	90322	1000
0.68	5.1 $\times$ 14.1 (16.5) $\times$ 12.5	0.6	15684	2000	1000	1100	90323	1500
0.82	5.5 $\times$ 14.5 (17.0) $\times$ 12.5	0.6	15824	2000	1000	1000	90324	1250
1	6.0 $\times$ 15.0 (17.5) $\times$ 12.5	0.8	15105	2000	1000	900	90325	1250

**U<sub>Rdc</sub> = 100 V; U<sub>Rac</sub> = 63 V**

C ( $\mu$ F)	DIMENSIONS $w_{max} \times h_{max} \times l_{max}$ (mm)	MASS (g)	CATALOG NUMBER 2222 368 ..... AND PACKAGING					
			LOOSE IN BOX			REEL	LOOSE IN BOX	
			$l_t =$ 4.0 + 1.0/- 0.5 mm	short leads	long leads	SPQ	$l_t =$ 4.0 + 1.0/- 0.5 mm	SPQ
			C-tol = $\pm$ 10 %				C-tol = $\pm$ 10 %	
last 5 digits of catalog number	SPQ	SPQ	SPQ	last 5 digits of catalog number	SPQ			
<b>Pitch = 10.0 <math>\pm</math> 0.4 mm; <math>d_t</math> = 0.60 <math>\pm</math> 0.06 mm</b>							<b>lock lead</b>	
0.056	4.0 $\times$ 13.0 (15.0) $\times$ 12.5	0.4	25563	2000	1000	1500	90205	1250
0.068			25683				90206	
0.082	3.7 $\times$ 12.7 (15.0) $\times$ 12.5	0.4	25823	2000	1000	1500	90207	1250
0.1	4.0 $\times$ 13.0 (15.0) $\times$ 12.5	0.4	25104	2000	1000	1500	90208	1250
0.12	4.3 $\times$ 13.3 (15.0) $\times$ 12.5	0.4	25124	2000	1000	1500	90209	1250
0.15	3.9 $\times$ 12.9 (15.0) $\times$ 12.5	0.4	25154	2000	1000	1500	90211	1250
0.18	4.2 $\times$ 13.2 (15.5) $\times$ 12.5	0.5	25184	2000	1000	1300	90212	1100
0.22	4.5 $\times$ 13.6 (16.0) $\times$ 12.5	0.5	25224	2000	1000	1200	90213	1000
<b>Pitch = 15.0 <math>\pm</math> 0.4 mm; <math>d_t</math> = 0.80 <math>\pm</math> 0.08 mm</b>							<b>lock lead</b>	
0.27	5.0 $\times$ 14.0 (17.0) $\times$ 17.5	0.6	25274	2000	1000	1200	90214	1750
0.33			25334				90215	
0.39			25394				90216	
0.47	5.5 $\times$ 14.5 (17.5) $\times$ 17.5	0.7	25474	2000	1000	1100	90217	1500
0.56			25564				90218	
0.68	6.0 $\times$ 15.0 (18.0) $\times$ 17.5	0.9	25684	2000	1000	1000	90219	1500
0.82	6.5 $\times$ 15.5 (18.5) $\times$ 17.5	1.0	25824	1000	1000	900	90221	1250
1	7.5 $\times$ 16.5 (19.5) $\times$ 17.5	1.3	25105	1000	1000	800	90222	1000



C ( $\mu$ F)	DIMENSIONS $w_{max} \times h_{max} \times l_{max}$ (mm)	MASS (g)	CATALOG NUMBER 2222 368 ..... AND PACKAGING					
			LOOSE IN BOX			REEL	LOOSE IN BOX	
			$l_t =$ 4.0 + 1.0/- 0.5 mm	short leads	long leads	SPQ	$l_t =$ 4.0 + 1.0/- 0.5 mm	SPQ
			C-tol = $\pm$ 10 %				C-tol = $\pm$ 10 %	
last 5 digits of catalog number	SPQ	SPQ	SPQ	last 5 digits of catalog number	SPQ			
<b>Pitch = 22.5 <math>\pm</math> 0.4 mm; <math>d_t = 0.80 \pm 0.08</math> mm</b>							<b>lock lead</b>	
1.2 1.5	6.0 $\times$ 18.0 (21.0) $\times$ 26.0	2.5	25125 25155	1000	1000	650	90223 90224	1000
1.8	7.0 $\times$ 19.0 (22.0) $\times$ 26.0	3.2	25185	1000	1000	650	90225	900
2.2	7.5 $\times$ 19.5 (23.0) $\times$ 26.0	3.5	25225	1000	500	600	90226	750
2.7	8.5 $\times$ 21.5 (24.0) $\times$ 26.0	4.1	25275	1000	500	500	90227	600
3.3	9.0 $\times$ 22.0 (24.5) $\times$ 26.0	4.5	25335	1000	500	450	90228	600
<b>Pitch = 27.5 <math>\pm</math> 0.4 mm; <math>d_t = 0.80 \pm 0.08</math> mm</b>							<b>lock lead</b>	
3.9	9.0 $\times$ 22.0 (24.0) $\times$ 30.0	4.8	25395	500	500		90229	500
4.7	10.0 $\times$ 23.0 (25.0) $\times$ 30.0	5.5	25475	500	500		90178	400
5.6	11.0 $\times$ 24.0 (26.0) $\times$ 30.0	6.2	25565	500	250		90231	350
6.8	12.0 $\times$ 25.0 (27.0) $\times$ 30.0	6.8	25685	500	250		90232	350

$U_{Rdc} = 250$  V;  $U_{Rac} = 160$  V

C ( $\mu$ F)	DIMENSIONS $w_{max} \times h_{max} \times l_{max}$ (mm)	MASS (g)	CATALOG NUMBER 2222 368 ..... AND PACKAGING					
			LOOSE IN BOX			REEL	LOOSE IN BOX	
			$l_t =$ 4.0 + 1.0/- 0.5 mm	short leads	long leads	SPQ	$l_t =$ 4.0 + 1.0/- 0.5 mm	SPQ
			C-tol = $\pm$ 10 %				C-tol = $\pm$ 10 %	
last 5 digits of catalog number	SPQ	SPQ	SPQ	last 5 digits of catalog number	SPQ			
<b>Pitch = 10.0 <math>\pm</math> 0.4 mm; <math>d_t = 0.60 \pm 0.06</math> mm</b>							<b>lock lead</b>	
0.027	4.2 $\times$ 13.0 (15.0) $\times$ 12.5	0.4	45273	2000	1000	1500	90233	1250
0.033	4.6 $\times$ 13.0 (15.0) $\times$ 12.5	0.5	45333	2000	1000	1300	90234	1250
0.039	4.0 $\times$ 13.0 (15.0) $\times$ 12.5	0.4	45393	2000	1000	1500	90235	1250
0.047	4.5 $\times$ 13.5 (15.5) $\times$ 12.5	0.5	45473	2000	1000	1500	90176	1250
0.056 0.068	4.6 $\times$ 13.5 (15.5) $\times$ 12.5	0.5	45563 45683	2000	1000	1300	90236 90237	1100
0.082	4.4 $\times$ 13.4 (16.0) $\times$ 12.5	0.5	45823	2000	1000	1200	90238	1000
0.1	4.7 $\times$ 13.7 (16.0) $\times$ 12.5	0.5	45104	2000	1000	1200	90177	1000
<b>Pitch = 15.0 <math>\pm</math> 0.4 mm; <math>d_t = 0.80 \pm 0.08</math> mm</b>							<b>lock lead</b>	
0.12 0.15	5.0 $\times$ 14.0 (17.0) $\times$ 17.5	0.6	45124 45154	2000	1000	1200	90239 90241	1750
0.18	5.5 $\times$ 14.5 (17.5) $\times$ 17.5	0.7	45184	2000	1000	1100	90242	1500
0.22	6.0 $\times$ 15.0 (18.0) $\times$ 17.5	0.9	45224	2000	1000	1000	90243	1500
0.27	6.0 $\times$ 15.5 (18.5) $\times$ 17.5	1.0	45274	2000	1000	900	90244	1250
0.33	6.8 $\times$ 16.0 (19.0) $\times$ 17.5	1.2	45334	1000	1000	800	90245	1250
<b>Pitch = 22.5 <math>\pm</math> 0.4 mm; <math>d_t = 0.80 \pm 0.08</math> mm</b>							<b>lock lead</b>	
0.39	5.0 $\times$ 17.0 (20.0) $\times$ 26.0	1.8	45394	1000	1000	800	90246	1250
0.47	5.5 $\times$ 17.5 (20.5) $\times$ 26.0	2.2	45474	1000	1000	750	90247	1250
0.56	6.0 $\times$ 18.0 (21.0) $\times$ 26.0	2.5	45564	1000	1000	650	90248	1000
0.68	6.6 $\times$ 18.5 (21.5) $\times$ 26.0	2.8	45684	1000	1000	600	90249	1000
0.82	7.2 $\times$ 19.0 (22.0) $\times$ 26.0	3.2	45824	1000	1000	550	90251	900
1	8.0 $\times$ 20.0 (23.0) $\times$ 26.0	3.8	45105	1000	500	500	90252	750



Metallized Polyester Film Capacitors Vishay BCcomponents  
MKT Radial Epoxy Lacquered Type

C ( $\mu$ F)	DIMENSIONS $w_{max} \times h_{max} \times l_{max}$ (mm)	MASS (g)	CATALOG NUMBER 2222 368 ..... AND PACKAGING					
			LOOSE IN BOX			REEL	LOOSE IN BOX	
			$l_t =$ 4.0 + 1.0/- 0.5 mm	short leads	long leads	SPQ	$l_t =$ 4.0 + 1.0/- 0.5 mm	SPQ
			C-tol = $\pm$ 10 %				C-tol = $\pm$ 10 %	
last 5 digits of catalog number	SPQ	SPQ	SPQ	last 5 digits of catalog number	SPQ			
Pitch = 27.5 $\pm$ 0.4 mm; $d_t = 0.80 \pm 0.08$ mm							lock lead	
1.2	8.0 $\times$ 21.0 (23.0) $\times$ 30.0	4.1	45125	500	500		90253	600
1.5	9.0 $\times$ 22.0 (25.0) $\times$ 30.0	4.8	45155	500	500		90254	450
1.8	10.0 $\times$ 23.0 (26.0) $\times$ 30.0	5.5	45185	500	500		90255	400
2.2	11.0 $\times$ 24.0 (27.0) $\times$ 30.0	6.2	45225	500	250		90256	350

$U_{Rdc} = 400$  V;  $U_{Rac} = 220$  V

C ( $\mu$ F)	DIMENSIONS $w_{max} \times h_{max} \times l_{max}$ (mm)	MASS (g)	CATALOG NUMBER 2222 368 ..... AND PACKAGING					
			LOOSE IN BOX			REEL	LOOSE IN BOX	
			$l_t =$ 4.0 + 1.0/- 0.5 mm	short leads	long leads	SPQ	$l_t =$ 4.0 + 1.0/- 0.5 mm	SPQ
			C-tol = $\pm$ 10 %				C-tol = $\pm$ 10 %	
last 5 digits of catalog number	SPQ	SPQ	SPQ	last 5 digits of catalog number	SPQ			
Pitch = 10.0 $\pm$ 0.4 mm; $d_t = 0.60 \pm 0.06$ mm							lock lead	
0.001	4.5 $\times$ 13.5 (15.5) $\times$ 12.5	0.5	55102	2000	1000	1500	90257	1100
0.0012			55122				90258	
0.0015			55152				90259	
0.0018			55182				90261	
0.0022	4.0 $\times$ 13.0 (15.5) $\times$ 12.5	0.5	55222	2000	1000	1500	90262	1100
0.0027	4.3 $\times$ 13.3 (15.5) $\times$ 12.5	0.5	55272	2000	1000	1500	90263	1100
0.0033	4.6 $\times$ 13.6 (15.5) $\times$ 12.5	0.5	55332	2000	1000	1500	90264	1100
0.0039	4.0 $\times$ 13.0 (15.5) $\times$ 12.5	0.5	55392	2000	1000	1500	90265	1100
0.0047	4.1 $\times$ 13.2 (15.5) $\times$ 12.5	0.5	55472	2000	1000	1500	90266	1100
0.0056	4.6 $\times$ 13.6 (15.5) $\times$ 12.5	0.5	55562	2000	1000	1500	90267	1100
0.0068			55682				90268	
0.0082			55822				90269	
0.01			55103				90271	
0.012	4.0 $\times$ 13.0 (15.5) $\times$ 12.5	0.5	55123	2000	1000	1500	90272	1100
0.015	4.1 $\times$ 13.0 (15.5) $\times$ 12.5	0.5	55153	2000	1000	1300	90273	1100
0.018	4.4 $\times$ 13.0 (15.5) $\times$ 12.5	0.5	55183	2000	1000	1500	90274	1100
0.022	4.2 $\times$ 12.9 (15.5) $\times$ 12.5	0.5	55223	2000	1000	1500	90175	1100
0.027	4.2 $\times$ 13.2 (15.5) $\times$ 12.5	0.5	55273	2000	1000	1300	90275	1100
0.033	4.6 $\times$ 13.7 (15.5) $\times$ 12.5	0.5	55333	2000	1000	1300	90188	1100
Pitch = 15.0 $\pm$ 0.4 mm; $d_t = 0.80 \pm 0.08$ mm							lock lead	
0.039	5.0 $\times$ 13.9 (16.5) $\times$ 17.5	0.6	55393	2000	1000	1200	90276	2000
0.047	5.4 $\times$ 14.5 (17.0) $\times$ 17.5	0.7	55473	2000	1000	1200	90277	1750
0.056	5.0 $\times$ 13.7 (16.5) $\times$ 17.5	0.6	55563	2000	1000	1200	90278	2000
0.068	5.0 $\times$ 13.5 (16.5) $\times$ 17.5	0.6	55683	2000	1000	1200	90279	2000
0.082	4.8 $\times$ 14.0 (16.5) $\times$ 17.5	0.6	55823	2000	1000	1100	90281	2000
0.1	5.3 $\times$ 14.5 (17.5) $\times$ 17.5	0.7	55104	2000	1000	1000	90186	1500
0.12	5.7 $\times$ 15.0 (18.0) $\times$ 17.5	0.9	55124	1000	1000	900	90282	1500
0.15	6.4 $\times$ 15.5 (18.5) $\times$ 17.5	1.0	55154	1000	1000	800	90187	1250



C ( $\mu$ F)	DIMENSIONS $W_{max} \times h_{max} \times l_{max}$ (mm)	MASS (g)	CATALOG NUMBER 2222 368 ..... AND PACKAGING					
			LOOSE IN BOX			REEL	LOOSE IN BOX	
			$l_t =$ 4.0 + 1.0/- 0.5 mm	short leads	long leads	SPQ	$l_t =$ 4.0 + 1.0/- 0.5 mm	SPQ
			C-tol = $\pm$ 10 %				C-tol = $\pm$ 10 %	
last 5 digits of catalog number	SPQ	SPQ	SPQ	last 5 digits of catalog number	SPQ			
<b>Pitch = 22.5 <math>\pm</math> 0.4 mm; <math>d_t</math> = 0.80 <math>\pm</math> 0.08 mm</b>							<b>lock lead</b>	
0.18	5.6 $\times$ 17.5 (20.5) $\times$ 26.0	2.2	55184	1000	1000	800	90283	1250
0.22	6.3 $\times$ 18.5 (21.5) $\times$ 26.0	2.8	55224	1000	1000	650	90284	1000
0.27	6.0 $\times$ 18.0 (21.0) $\times$ 26.0	2.5	55274	1000	1000	650	90285	1000
0.33	6.4 $\times$ 18.5 (21.5) $\times$ 26.0	2.8	55334	1000	1000	650	90286	1000
0.39	7.1 $\times$ 19.0 (21.5) $\times$ 26.0	2.8	55394	1000	1000	550	90287	900
0.47	8.0 $\times$ 20.0 (22.5) $\times$ 26.0	3.8	55474	1000	500	500	90179	750
<b>Pitch = 27.5 <math>\pm</math> 0.4 mm; <math>d_t</math> = 0.80 <math>\pm</math> 0.08 mm</b>							<b>lock lead</b>	
0.56	7.5 $\times$ 20.5 (22.5) $\times$ 30.0	3.8	55564	500	500		90288	600
0.68	8.5 $\times$ 21.5 (23.5) $\times$ 30.0	4.5	55684	500	500		90289	500
0.82	9.5 $\times$ 22.5 (24.5) $\times$ 30.0	5.2	55824	500	500		90291	450
1	10.5 $\times$ 23.5 (26.5) $\times$ 30.0	5.8	55105	500	250		90292	350

$U_{Rdc} = 630$  V;  $U_{Rac} = 250$  V

C ( $\mu$ F)	DIMENSIONS $W_{max} \times h_{max} \times l_{max}$ (mm)	MASS (g)	CATALOG NUMBER 2222 368 ..... AND PACKAGING					
			LOOSE IN BOX			REEL	LOOSE IN BOX	
			$l_t =$ 4.0 + 1.0/- 0.5 mm	short leads	long leads	SPQ	$l_t =$ 4.0 + 1.0/- 0.5 mm	SPQ
			C-tol = $\pm$ 10 %				C-tol = $\pm$ 10 %	
last 5 digits of catalog number	SPQ	SPQ	SPQ	last 5 digits of catalog number	SPQ			
<b>Pitch = 10.0 <math>\pm</math> 0.4 mm; <math>d_t</math> = 0.60 <math>\pm</math> 0.06 mm</b>							<b>lock lead</b>	
0.01	4.3 $\times$ 13.1 (15.5) $\times$ 12.5	0.5	65103	2000	1000	1300	90293	1100
0.012	4.6 $\times$ 13.4 (16.0) $\times$ 12.5	0.5	65123	2000	1000	1200	90294	1000
0.015	4.9 $\times$ 13.9 (16.5) $\times$ 12.5	0.6	65153	2000	1000	1100	90295	1500
0.018	5.3 $\times$ 14.3 (17.0) $\times$ 12.5	0.6	65183	2000	1000	1000	90296	1250
0.022	5.9 $\times$ 14.9 (17.5) $\times$ 12.5	0.8	65223	2000	1000	900	90297	1250
<b>Pitch = 15.0 <math>\pm</math> 0.4 mm; <math>d_t</math> = 0.80 <math>\pm</math> 0.08 mm</b>							<b>lock lead</b>	
0.027	5.5 $\times$ 14.5 (17.5) $\times$ 17.5	0.7	65273	2000	1000	1100	90298	1500
0.033	6.0 $\times$ 15.0 (18.0) $\times$ 17.5	0.9	65333	2000	1000	1000	90299	1500
0.039	6.3 $\times$ 15.5 (18.5) $\times$ 17.5	1.0	65393	2000	1000	900	90301	1250
0.047	7.0 $\times$ 16.0 (19.0) $\times$ 17.5	1.2	65473	2000	1000	800	90302	1250
0.056	7.5 $\times$ 16.5 (19.5) $\times$ 17.5	1.3	65563	1000	1000	800	90303	1000
0.068	8.0 $\times$ 17.0 (20.0) $\times$ 17.5	1.4	65683	1000	1000	750	90304	1000
<b>Pitch = 22.5 <math>\pm</math> 0.4 mm; <math>d_t</math> = 0.80 <math>\pm</math> 0.08 mm</b>							<b>lock lead</b>	
0.082	6.1 $\times$ 18.0 (21.0) $\times$ 26.0	2.5	65823	1000	1000	750	90305	1000
0.1	7.0 $\times$ 19.0 (22.0) $\times$ 26.0	3.2	65104	1000	1000	650	90306	900
0.12	7.2 $\times$ 19.5 (22.5) $\times$ 26.0	3.5	65124	1000	1000	550	90307	750
0.15	8.0 $\times$ 21.0 (23.0) $\times$ 26.0	3.8	65154	1000	500	500	90308	750
0.18	9.0 $\times$ 22.0 (24.0) $\times$ 26.0	4.5	65184	1000	500	450	90309	600
0.22	10.0 $\times$ 23.0 (25.0) $\times$ 26.0	5.2	65224	1000	500	400	90311	550



C ( $\mu$ F)	DIMENSIONS $w_{max} \times h_{max} \times l_{max}$ (mm)	MASS (g)	CATALOG NUMBER 2222 368 ..... AND PACKAGING						
			LOOSE IN BOX			REEL	LOOSE IN BOX		
			$l_t =$ 4.0 + 1.0/- 0.5 mm	short leads	long leads	SPQ	$l_t =$ 4.0 + 1.0/- 0.5 mm	SPQ	
			C-tol = $\pm 10\%$				C-tol = $\pm 10\%$		
last 5 digits of catalog number						SPQ	last 5 digits of catalog number		SPQ
Pitch = 27.5 $\pm$ 0.4 mm; $d_t = 0.80 \pm 0.08$ mm							lock lead		
0.27	10.0 $\times$ 23.0 (25.0) $\times$ 30.0	5.5	65274	500	500		90312	400	
0.33	11.5 $\times$ 24.5 (26.5) $\times$ 30.0	6.5	65334	500	250		90313	350	
0.39	12.5 $\times$ 25.5 (28.5) $\times$ 30.0	7.1	65394	500	250		90314	300	
0.47	14.0 $\times$ 27.0 (30.0) $\times$ 30.0	8.2	65474	250	250		90315	250	

**CAPACITANCE**

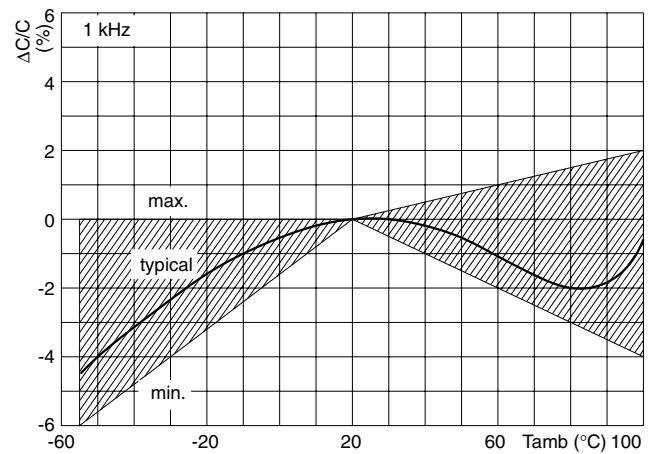
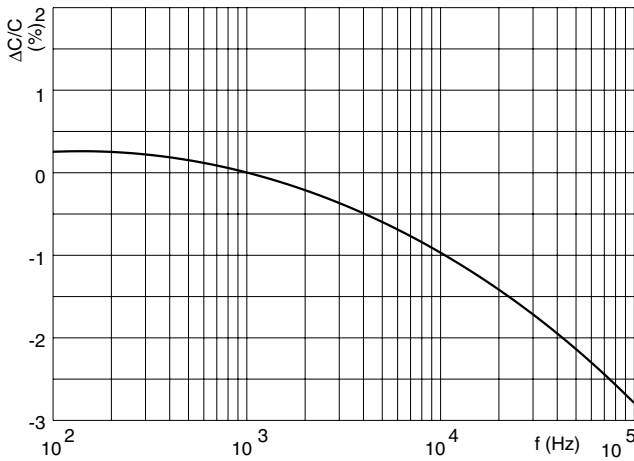

**IMPEDANCE**

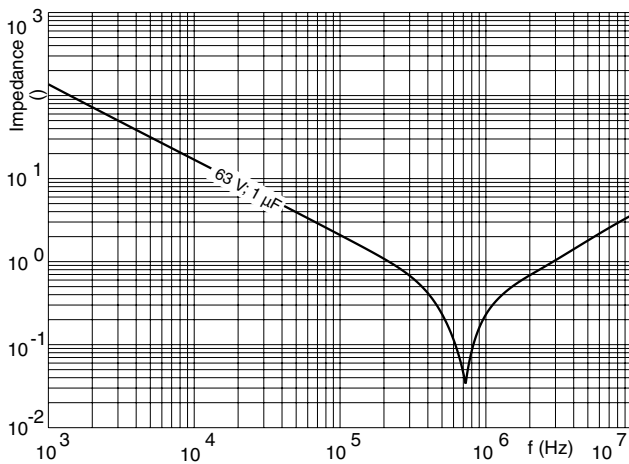

## MAXIMUM RMS VOLTAGE (SINEWAVE) AS A FUNCTION OF FREQUENCY

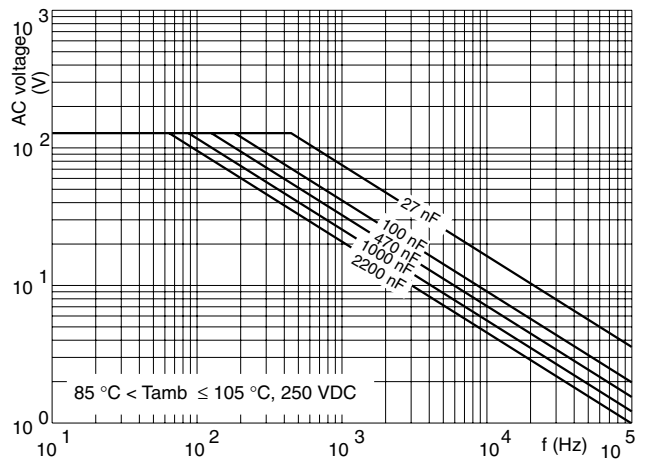
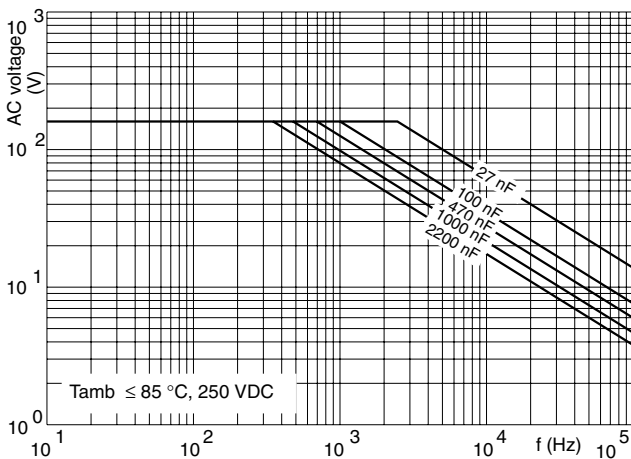
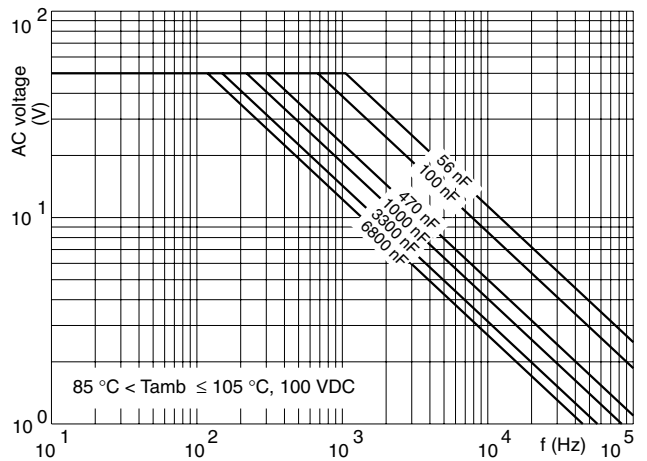
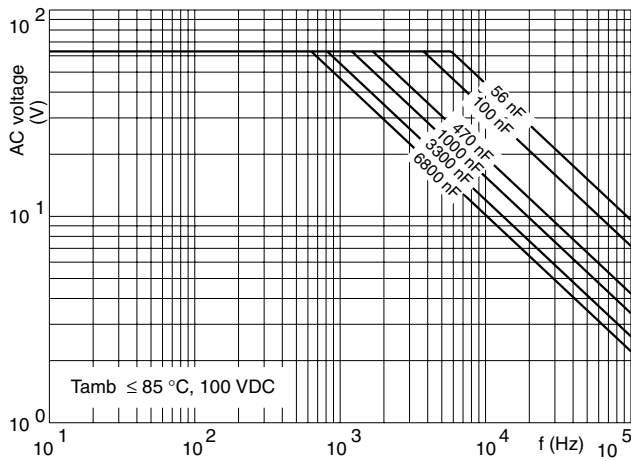
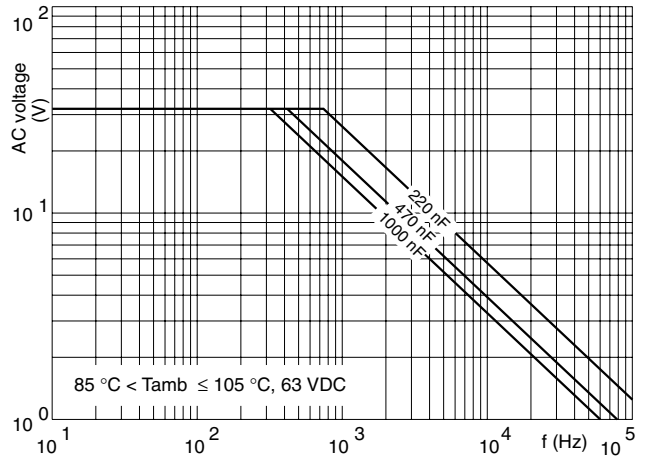
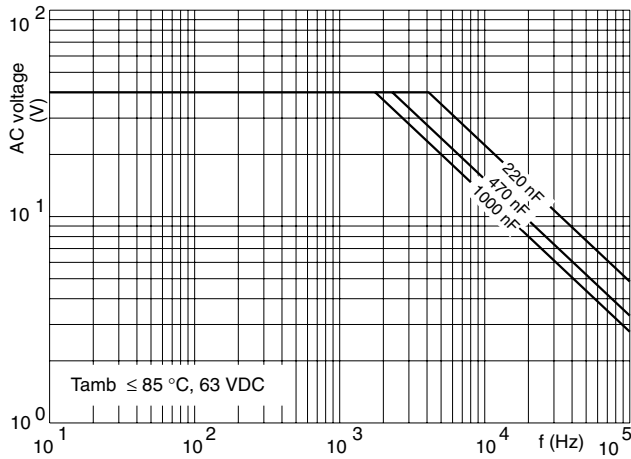



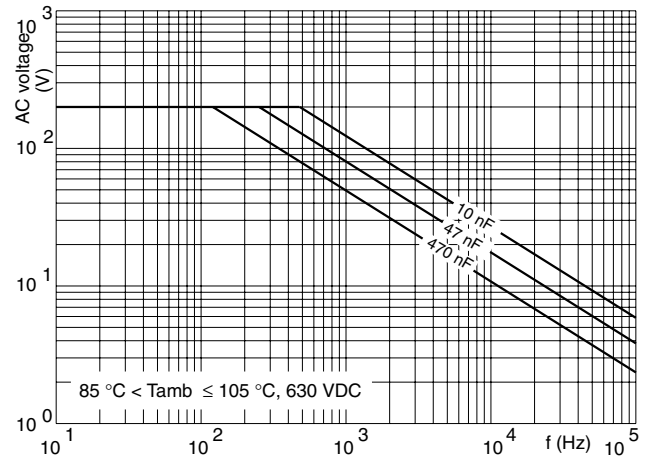
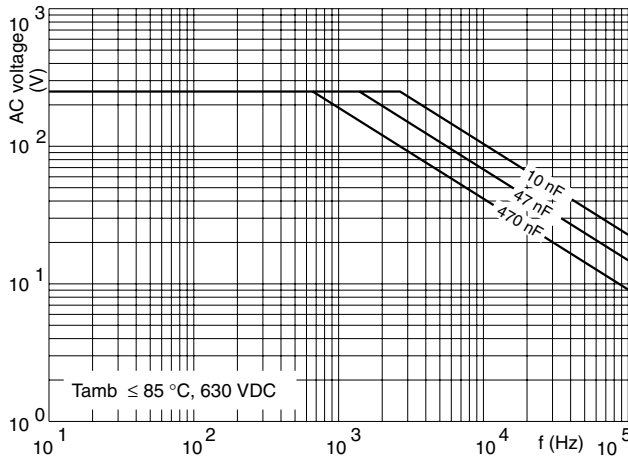
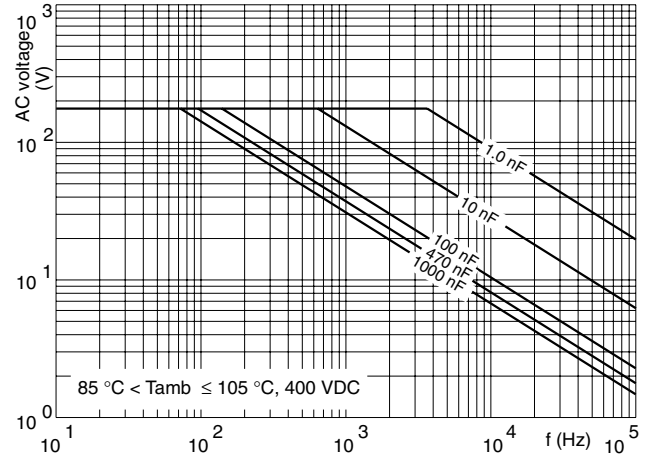
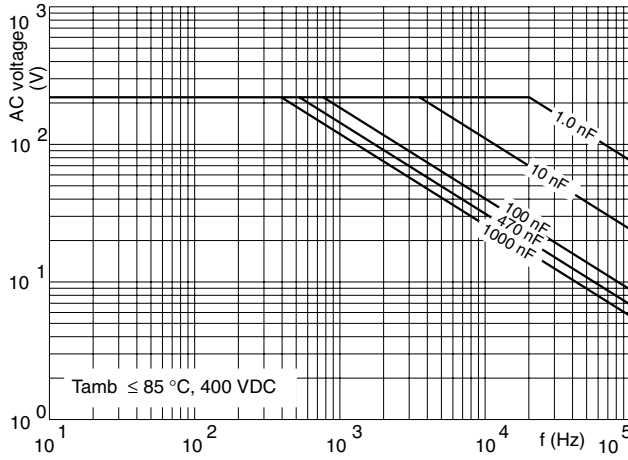



## Disclaimer

ALL PRODUCT, PRODUCT SPECIFICATIONS AND DATA ARE SUBJECT TO CHANGE WITHOUT NOTICE TO IMPROVE RELIABILITY, FUNCTION OR DESIGN OR OTHERWISE.

Vishay Intertechnology, Inc., its affiliates, agents, and employees, and all persons acting on its or their behalf (collectively, "Vishay"), disclaim any and all liability for any errors, inaccuracies or incompleteness contained in any datasheet or in any other disclosure relating to any product.

Vishay makes no warranty, representation or guarantee regarding the suitability of the products for any particular purpose or the continuing production of any product. To the maximum extent permitted by applicable law, Vishay disclaims (i) any and all liability arising out of the application or use of any product, (ii) any and all liability, including without limitation special, consequential or incidental damages, and (iii) any and all implied warranties, including warranties of fitness for particular purpose, non-infringement and merchantability.

Statements regarding the suitability of products for certain types of applications are based on Vishay's knowledge of typical requirements that are often placed on Vishay products in generic applications. Such statements are not binding statements about the suitability of products for a particular application. It is the customer's responsibility to validate that a particular product with the properties described in the product specification is suitable for use in a particular application. Parameters provided in datasheets and/or specifications may vary in different applications and performance may vary over time. All operating parameters, including typical parameters, must be validated for each customer application by the customer's technical experts. Product specifications do not expand or otherwise modify Vishay's terms and conditions of purchase, including but not limited to the warranty expressed therein.

Except as expressly indicated in writing, Vishay products are not designed for use in medical, life-saving, or life-sustaining applications or for any other application in which the failure of the Vishay product could result in personal injury or death. Customers using or selling Vishay products not expressly indicated for use in such applications do so at their own risk and agree to fully indemnify and hold Vishay and its distributors harmless from and against any and all claims, liabilities, expenses and damages arising or resulting in connection with such use or sale, including attorneys fees, even if such claim alleges that Vishay or its distributor was negligent regarding the design or manufacture of the part. Please contact authorized Vishay personnel to obtain written terms and conditions regarding products designed for such applications.

No license, express or implied, by estoppel or otherwise, to any intellectual property rights is granted by this document or by any conduct of Vishay. Product names and markings noted herein may be trademarks of their respective owners.