

Total solder points: 57

Difficulty level: *beginner* 1 2 3 4 5 *advanced*

3 TO 30VDC / 3A POWER SUPPLY

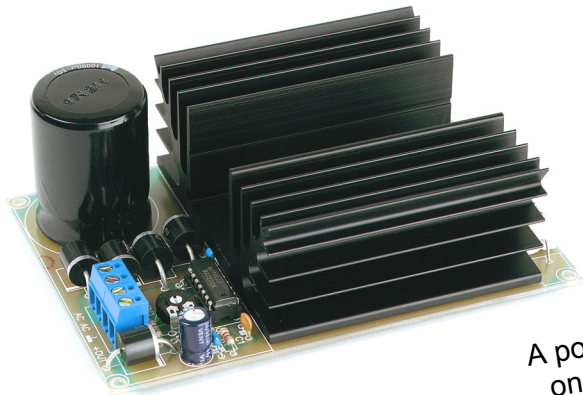

K7203

A power supply for all our kits, based on a stabilised DC voltage of 30V.

This kit is meant as an auxiliary or as a permanent power supply for all common Velleman kits based on a stabilized DC voltage between 3 and 30V provided that the consumption does not exceed 3A.

Of course this power supply unit can be used for other purposes, as long as the maximum specifications are taken into account.

Technical data :

- Short circuit protected
- Overload protected
- Heatsink included
- Output voltage: adjustable 3 to 30V stabilized.
- Output current: max. 3A
- Output ripple voltage: 0.5mV.
- Input: 9 to 30V transformer, depending on the desired output
- Dimensions (LxWxH): 130x91x50mm

⚠ Transformer not included

1. Assembly (Skipping this can lead to troubles !)

Ok, so we have your attention. These hints will help you to make this project successful. Read them carefully.

1.1 Make sure you have the right tools:

- A good quality soldering iron (25-40W) with a small tip.
- Wipe it often on a wet sponge or cloth, to keep it clean; then apply solder to the tip, to give it a wet look. This is called 'thinning' and will protect the tip, and enables you to make good connections. When solder rolls off the tip, it needs cleaning.
- Thin raisin-core solder. Do not use any flux or grease.
- A diagonal cutter to trim excess wires. To avoid injury when cutting excess leads, hold the lead so they cannot fly towards the eyes.
- Needle nose pliers, for bending leads, or to hold components in place.
- Small blade and Phillips screwdrivers. A basic range is fine.

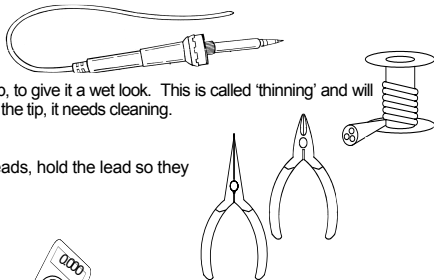

For some projects, a basic multi-meter is required, or might be handy

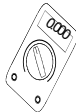

1.2 Assembly Hints :

- ⇒ Make sure the skill level matches your experience, to avoid disappointments.
 - ⇒ Follow the instructions carefully. Read and understand the entire step before you perform each operation.
 - ⇒ Perform the assembly in the correct order as stated in this manual
 - ⇒ Position all parts on the PCB (Printed Circuit Board) as shown on the drawings.
 - ⇒ Values on the circuit diagram are subject to changes.
 - ⇒ Values in this assembly guide are correct*
 - ⇒ Use the check-boxes to mark your progress.
 - ⇒ Please read the included information on safety and customer service
- * Typographical inaccuracies excluded. Always look for possible last minute manual updates, indicated as 'NOTE' on a separate leaflet.

1.3 Soldering Hints :

1- Mount the component against the PCB surface and carefully solder the leads

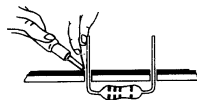

2- Make sure the solder joints are cone-shaped and shiny

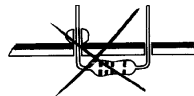
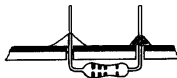

3- Trim excess leads as close as possible to the solder joint

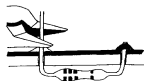

AXIAL COMPONENTS ARE TAPED IN THE CORRECT MOUNTING SEQUENCE !

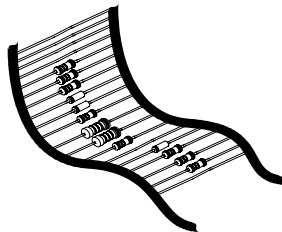

REMOVE THEM FROM THE TAPE ONE AT A TIME !

 You will find the colour code for the resistances and the LEDs in the HALG (general manual) and on our website: <http://www.velleman.be/common/service.aspx>

1. Resistors

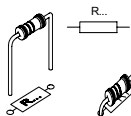

- R1 : 8K2 (8 - 2 - 2 - B)
- R2 (Uout = output voltage)

Uout 3...8V : 5K6 (5 - 6 - 2 - B)
 Uout 8...30V : 2K2 (2 - 2 - 2 - B)

- R3 : 680 (6 - 8 - 1 - B)
- R4 : 1K (1 - 0 - 2 - B)
- R5 : 82K (8 - 2 - 3 - B)

2. IC sockets, Watch the position of the notch !

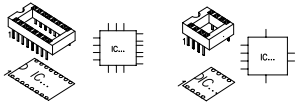

- IC1 : 14P

3. Capacitors.

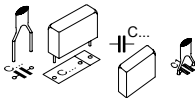

- C1 : 470pF (471)
- C2 : 100nF (104)
- C3 : 100nF (104)

4. Resistor trimmer

- RV1 : 10K

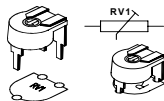

5. Diodes. Watch the polarity!

- D1 : 6A2 or 6A6
- D2 : 6A2 or 6A6
- D3 : 6A2 or 6A6
- D4 : 6A2 or 6A6
- D5 : 6A2 or 6A6
- D6 : 6A2 or 6A6

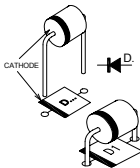

6. 5W resistor.

- R6 : 0.18E

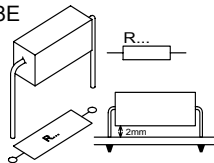

7. Screw connectors

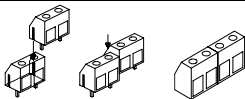

- J1 : 2 x 2p

8. Electrolytic Capacitor. Watch the polarity !

- C4 : 100μF
- C5 : 10.000μF

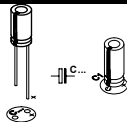

9. Power transistor

□ T1 : MJ3001 or 2N6284G

Apply some thermo-conducting pasta to the bottom side of the transistor and mount it on the PCB simultaneously with the cooling profile following the instructions in the figure 1.0.

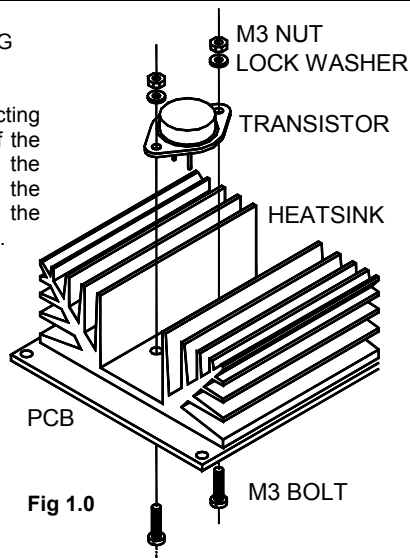

10. IC. Watch the position of the notch!

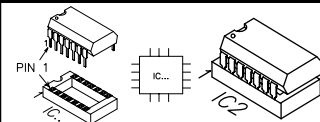

□ IC1 : UA723D

11. Assembly into a housing

Depending on the transformer used, one may choose one of two housings with the following reference nr. for ordering: L750 or L760.

If the circuit is to be integrated into another housing, it must be provided with ventilation holes (one may make these holes oneself), necessary for the release of the heat developed.

If a metal housing is used, it must be earthed for security purposes.

☞ Make sure the cooling body does not touch the housing. This might cause a short circuit.

When mounting a toroidal transformer, it must be seen to that the fixation bolt does not touch the cover. This might cause the burning of the transformer

12. Connection

Depending on the output voltage needed, one should choose the right transformer for connection to the circuit according to the table in the parts list. If one chooses too high an input voltage, it may well be so that the power transistor is overheated.

The secondary winding of the transformer is connected to the AC points. It may be that the transformer has two secondary windings which should be connected either in parallel or in series. The colour code can be found on the packaging.

- ⚡ For safety reasons, the primary winding of the transformer is connected to the mains voltage via a mains switch and a fuse. The rating of the fuse can be selected from the table in the parts list.
- Connect a voltage meter to the points 'GND' and '+OUT' and adjust 'RV1' until the desired output voltage is reached.
- Connect the circuit to be supplied by the present unit between the points 'GND' and '+OUT'. Watch the polarity!

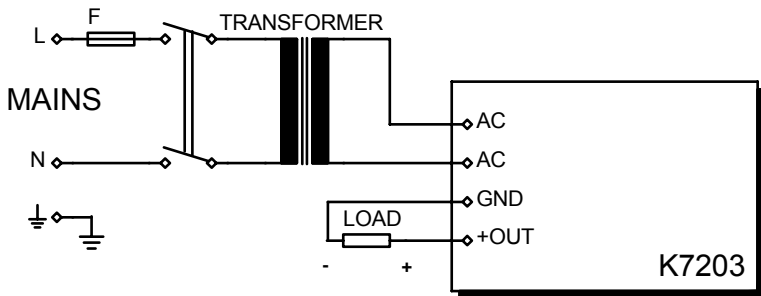

Desired regulated output voltage	R2	Desired transformer ordercode only @230VAC	Desired fuse 230VAC	Desired fuse 110VAC
3...5V	5K6	9V / 30VA - 309	160mA Slow	315mA Slow
5...8V	5K6	12V / 50VA - 5012	250mA Slow	500mA Slow
8...13V	2K2	15V / 50VA - 5015	250mA Slow	500mA Slow
13...15V	2K2	18V / 80VA - 8018	400mA Slow	800mA Slow
15...18V	2K2	22V / 80VA - 80220	400mA Slow	800mA Slow
18...22V	2K2	24V / 80VA - 8024	400mA Slow	800mA Slow
22...30V	2K2	30V /120VA - 12030	800mA Slow	1.5A Slow

13. PCB layout.

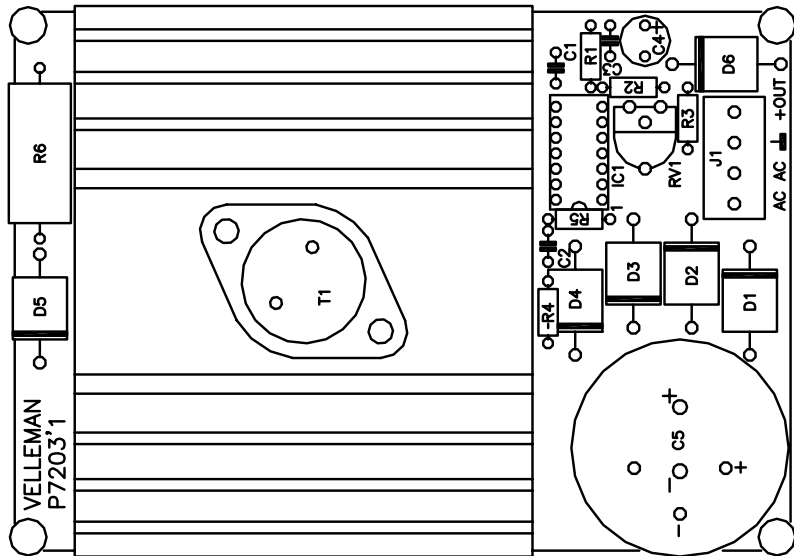

14. Diagram

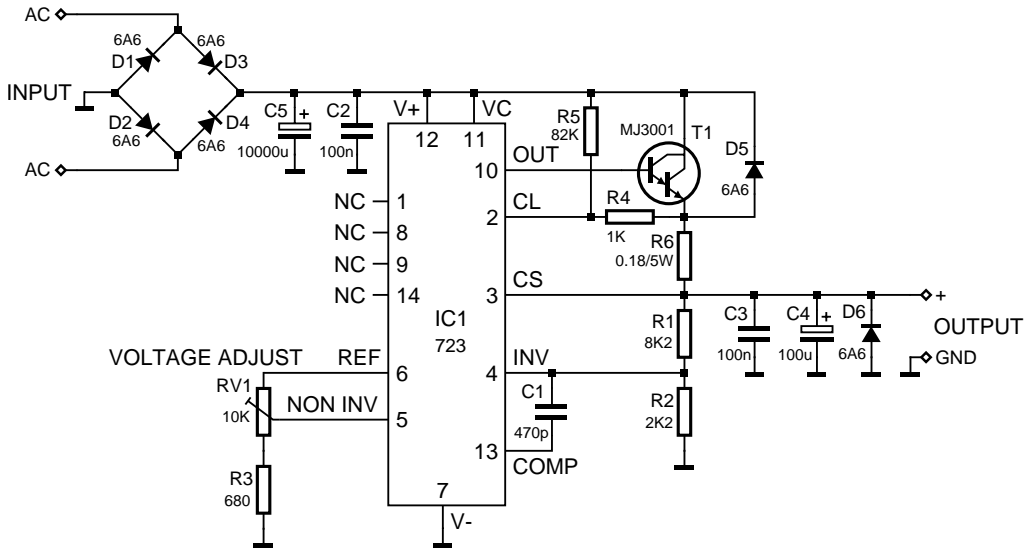



Modifications and typographical errors reserved
© Velleman Components nv.
H7203IP - 2010 - ED1 (Rev.1)

