

1

Resistor - Weerstand - Résistance - Widerstand - Resistencia - Motstand - Vastus - Resistenze

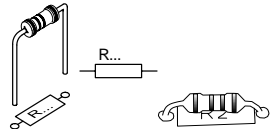

R1, R2, R3, R4: 10K	(Brown, Black, Orange) - (Bruin, Zwart, Oranje) - (Brun, Noir, Orange) - (Braun, Schwarz, Orange) - (Brun, Svart, Orange) - (Ruskea, Musta, Oranssi) - (Marrón, Negro, Naranjado) - (Castanho, Preto, Laranja) - (Marrone, Nero, Aranciato)
R5, R6, R7, R8: 1K	(Brown, Black, Red) - (Bruin, Zwart, Rood) - (Brun, Noir, Rouge) - (Braun, Schwarz, Rot) - (Brun, Svart, Röd) - (Ruskea, Musta, Punainen) - (Marrón, Negro, Rojo) - (Castanho, Preto, Encarnado) - (Marrone, Nero, Rosso)
R9, R10: 100K	(Brown, Black, Yellow) - (Bruin, zwart, Geel) - (Brun, Noir, Jaune) - (Braun, Schwarz, Gelb) - (Brun, Svart, Gul) - (Ruskea, Musta, Keltainen) - (Marrón, Negro, Amarillo) - (Castanho, Preto, Amarelo) - (Marrone, Nero, Giallo)
R11 : 0	(Black) - (Zwart) - (Noir) - (Schwarz) - (Svart) - (Musta) - (Negro) - (Preto) - (Nero)

2

DIOD

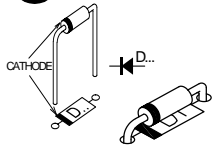

◇ D1 : BAT85
Watch the polarity!
Att. à la polarité!

3

ZENER DIODES

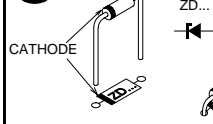

◇ ZD1 : 2V4
◇ ZD2 : 2V4
◇ ZD3 : 3V0
Watch the polarity!
Attention à la polarité!

4

IC SOCKET

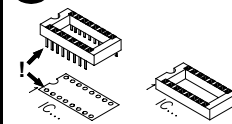

◇ IC1 : 14P
WATCH THE POSITION OF THE NOTCH!
ATTENTION A LA POSITION DE L'ENCOCHE!

5

PUSHBUTTON

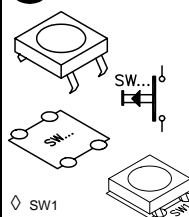

◇ SW1

6

LEDs

Watch the polarity!
Attention à la polarité!

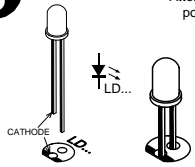

Open : red / rood / rouge / rot / röd / punainen / rojo / encarnado / rosso
Polarity OK : green / groen / grün / grön / vihreä / verde
Polarity INVERTED : red / rood / rouge / rot / röd / punainen / rojo / encarnado / rosso
Short : red / rood / rouge / rot / röd / punainen / rojo / encarnado / rosso

7

TRANSISTORS

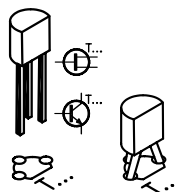

◇ T1 : BC557
◇ T2 : BC547

8

ELECTROLYTIC CAPACITORS

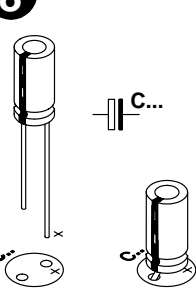

Watch the polarity!
Attention à la polarité!

◇ C1 : 47µF

9

IC SOCKET AND IC

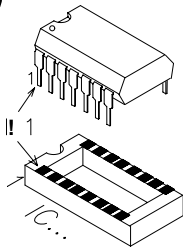

WATCH THE POSITION OF THE NOTCH!
ATTENTION A LA POSITION DE L'ENCOCHE!

◇ IC1 : LM324, LM224, LM124 or eq.

10

PREPARING THE TESTLEADS

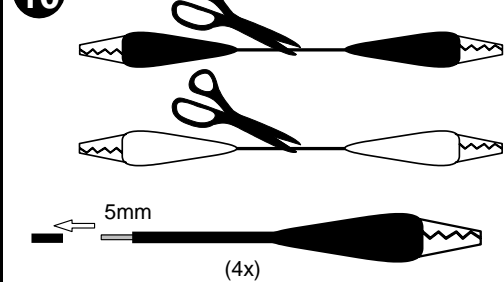

(4x)

11

CUT

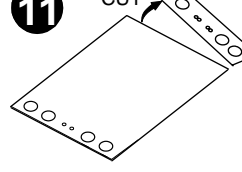

12

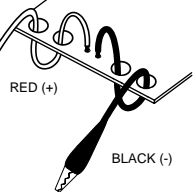

13

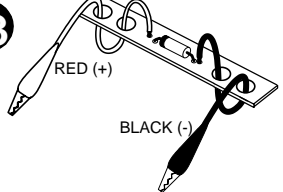

14

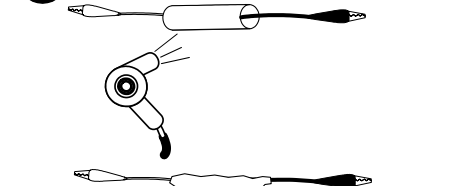

15

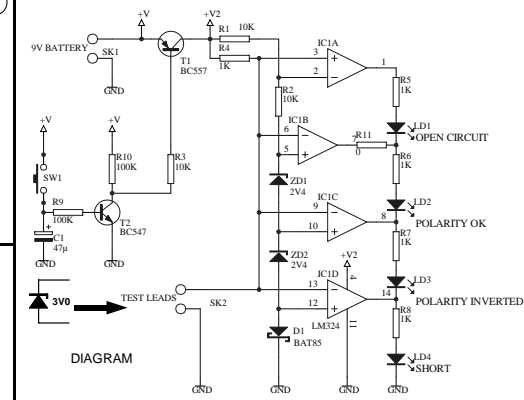
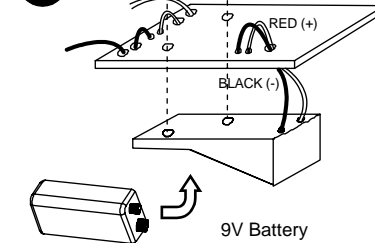

DO NOT ATTEMPT TO TEST LIVE WIRES / NIET METEN OP SPANNINGSVOEREND KABELS / N'ESSAYEZ PAS DE TESTER DES FILS SOUS TENSION / TESTEN SIE NUR SPANNUNGSLÖSE LEITER / NUNCA COMPRUEBE CABLES BAJO TENSION / NETESTUJTE KABLY POD NAPĚTÍM / TESTA ALDRIG STRÖMFORANDE KABLAR / MÁ IKKE ANVEND ES P KABLER, SOM ER STRÖMFORANDE / ALÄ KOSKAAN KOESTA JÄNNITTEILLISIÄ JOHTIMIA / PRECAUÇÃO: NÃO TENTAR TESTAR CIRCUITOS ATIVOS (CIRCUITOS COM CORRENTE ALTERNA) / NON TESTARE I CAVI SOTTO TENSIONE!