

1/4" Square, Single-Turn, Through-Hole Sealed Cermet Trimmers



Features

- 1/4" square, single-turn, through-hole, sealed cermet trimmers
- Top and side adjust styles available
- Larger diameter rotor than GF06 series for easier adjustment
- Precious metal, multi-contact wiper design
- Cross-slot design allows automatic machine adjustment
- Meets UL 94V-0 flammability requirements
- Sealed to withstand wave soldering and immersion cleaning processes
- Taping available, reel or ammo packaging

Specifications

Electrical

Standard Resistance Range	10Ω to 5MΩ (standard 1, 2 & 5 sequence)
Resistance Tolerance	±10% and ±20%
End Resistance	1% or 1Ω, whichever is greater
Resistance Taper	Linear
Peak Noise (C.R.V.)	1% or 1Ω, whichever is greater
Power Rating	0.5 watt at +70°C, 0 watt at +125°C
Maximum Input Voltage	250VDC or power rating, whichever is smaller
Temperature Coefficient	±100ppm/°C
Insulation Resistance	1,000MΩ minimum at 500VDC
Dielectric Strength	900VAC, 1 minute
Adjustment Travel	210° ± 10°

Mechanical

Mechanical Travel	250° ± 10°
Shaft Torque	200 gf·cm (2.77 oz·in) max.
Stop Strength	500 gf·cm (6.93 oz·in) min.
Flammability of Plastic Materials	Meets UL 94V-0
Nominal Weight	0.4g (P, P1, W, U) 0.5g (P2, S, S1, X, X1, U1, Y, Y1, V, V1)
Marking	Resistance code, date code, model type

For GF063 models available with a knob, refer to the GF063-K Series on page 68.

Environmental

Temperature Range	-55°C to +125°C
Low Temperature Operation	-55°C, 0.5 watt, 2 hours ΔT/R ≤ ±2%, S.S. ≤ ±2%
High Temperature Exposure	+125°C, 250 hours ΔT/R ≤ ±2%, S.S. ≤ ±2%
Load Life	+70°C, 0.5 watt, 1,000 hours ΔT/R ≤ ±3%, S.S. ≤ ±2%
Thermal Shock	-55°C, +125°C, 30 minutes each, 5 cycles ΔT/R ≤ ±1%, S.S. ≤ ±1%
Shock	100G, 6ms, 6 directions, 3 times each ΔT/R ≤ ±1%, S.S. ≤ ±1%
Vibration	10-2,000Hz, 1.5mm amplitude, 20G, 12 hours ΔT/R ≤ ±1%, S.S. ≤ ±1%
Humidity	+40°C, 90-95% RH, 0.5 watt, 500 hours ΔT/R ≤ ±3%, S.S. ≤ ±2%
Moisture Resistance	-10°C to +65°C, 80-98% RH, 0.5 watt, 10 cycles, 240 hours ΔT/R ≤ ±2%
Soldering Heat Resistance	350°C, 3 seconds ΔT/R ≤ ±1%
Seal Test	+85°C, hot water for 1 minute
Rotational Life	100 cycles without discontinuity ΔT/R ≤ ±(2Ω+3%)

ΔT/R = Total Resistance Change; S.S. = Setting Stability (voltage ratio)

GF063P Cross-Slot, Top Adjust, P Terminal Style

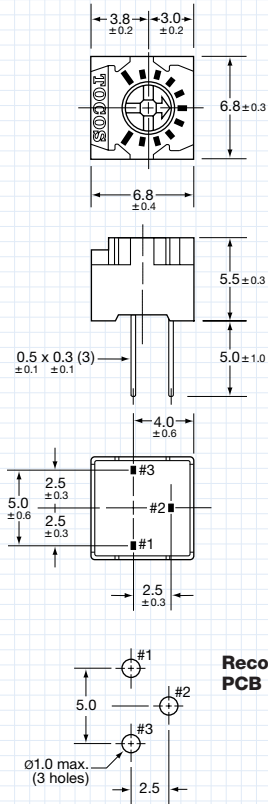

Recommended PCB Layout

GF063P1 Cross-Slot, Top Adjust, P1, P1-3* & P1-LM* Terminal Styles

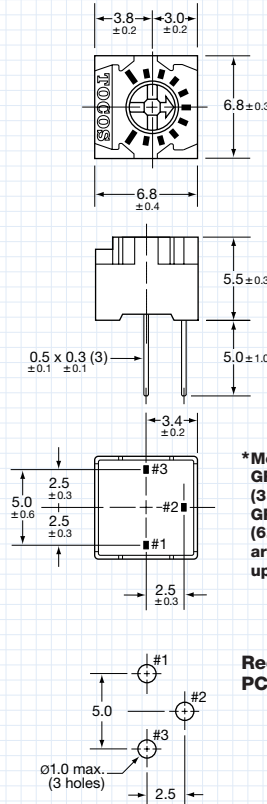

*Models GF063P1-3 (3mm leads) and GF063P1-LM (6.5mm leads) are available upon request.

Recommended PCB Layout

GF063P2 Cross-Slot, Top Adjust, P2 Terminal Style

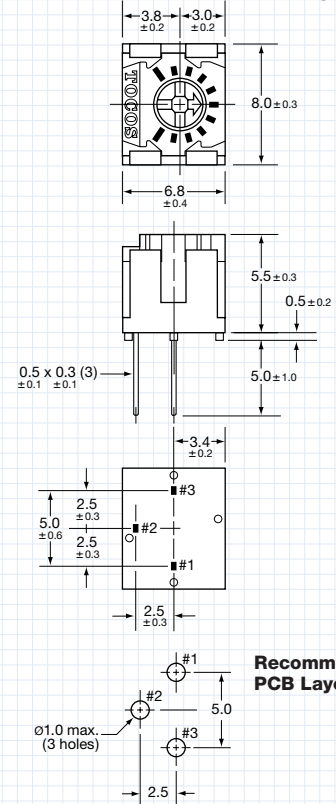

Unit: mm

Recommended PCB Layout

GF063W Cross-Slot, Top Adjust, W Terminal Style

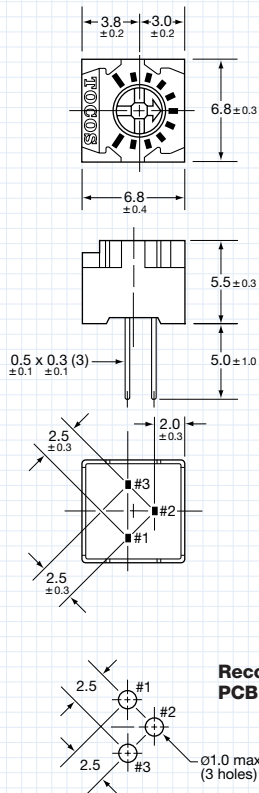

Recommended PCB Layout

GF063U Cross-Slot, Top Adjust, U & U-LL* Terminal Styles

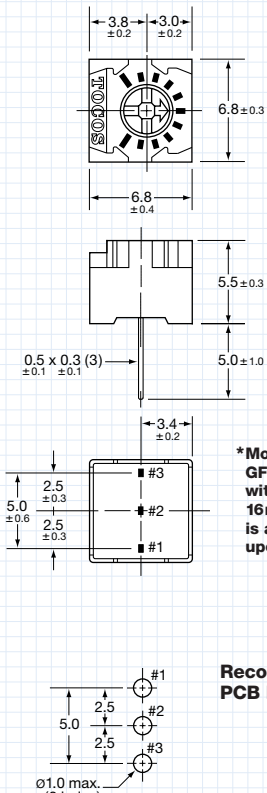

*Model GF063U-LL with longer 16mm leads is available upon request.

Recommended PCB Layout

GF063U1 Cross-Slot, Top Adjust, U1 Terminal Style

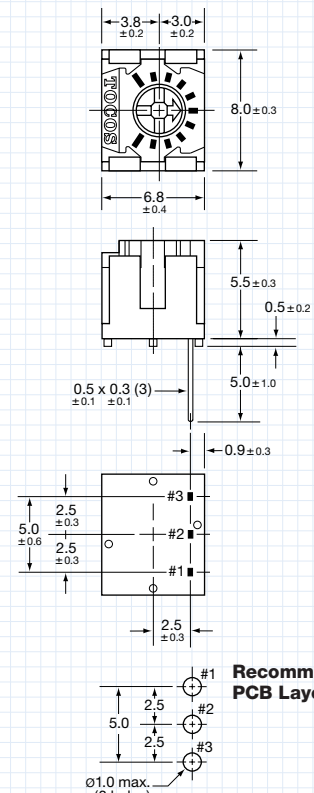

Recommended PCB Layout

GF063Y
Y Terminal Style, Cross-Slot, Top Adjust

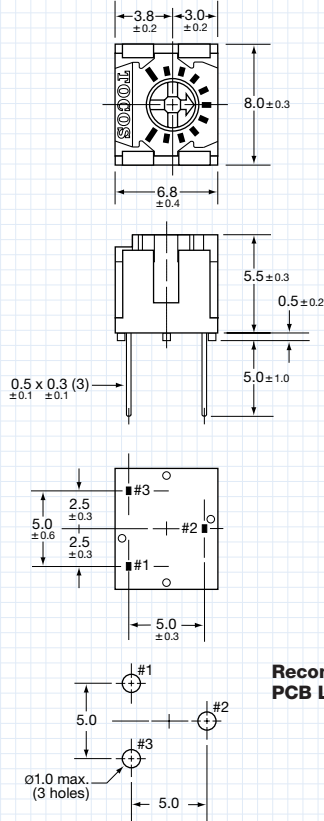

GF063Y1
Y1 Terminal Style, Cross-Slot, Top Adjust

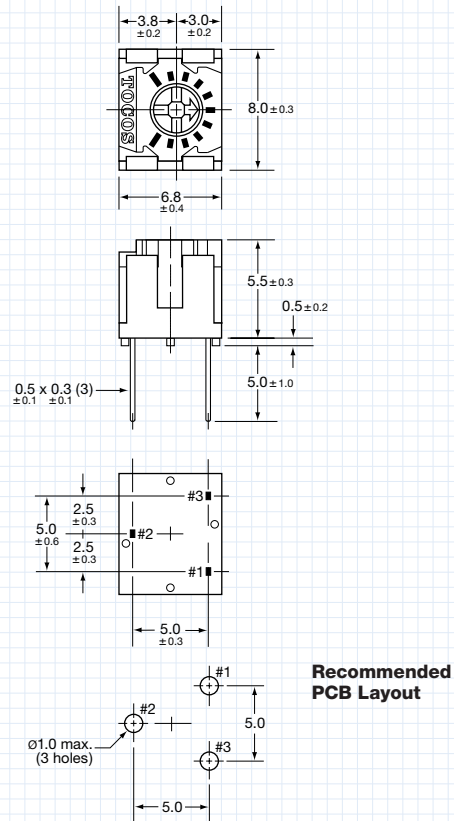

GF063S
S Terminal Style, Cross-Slot, Side Adjust

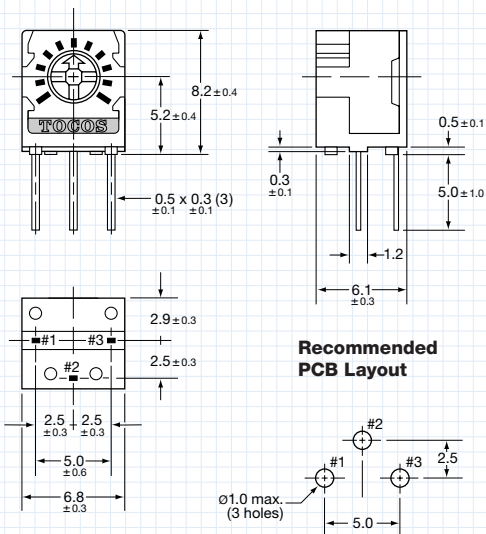

GF063S1
S1 Terminal Style, Cross-Slot, Side Adjust

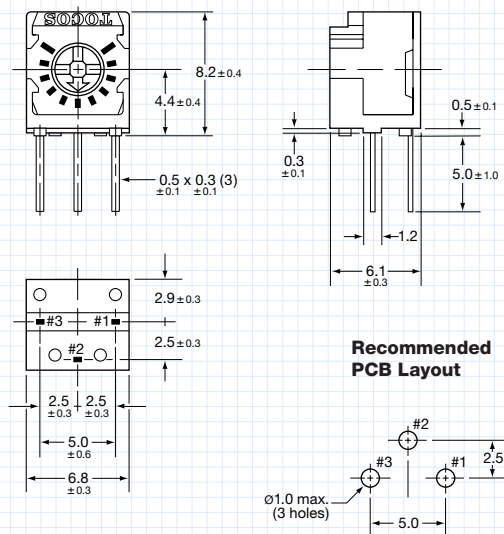

Tape Dimensions

Conforms to EIA-468-B and JIS-C-0805

PT, PT2, P1T, P1T2

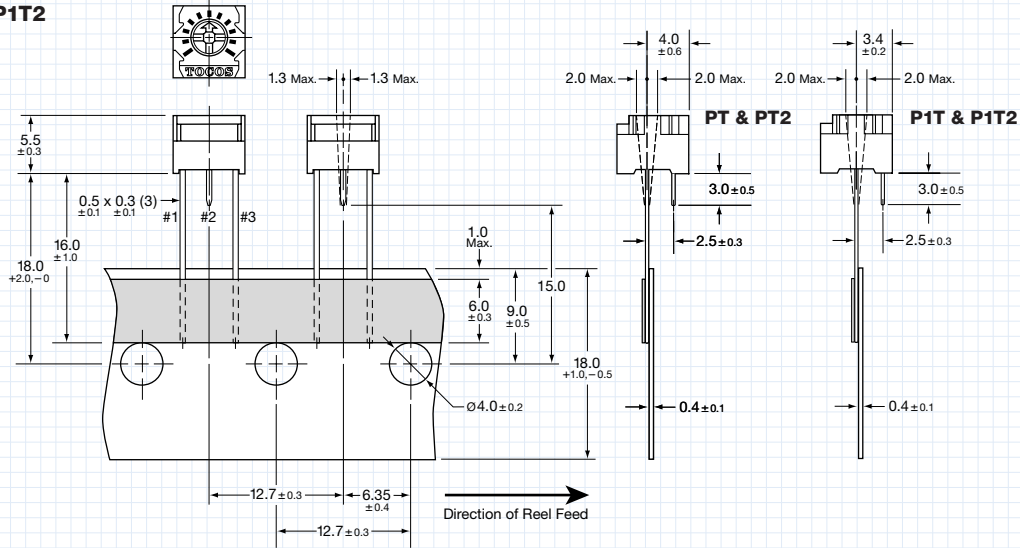

UT, UT2

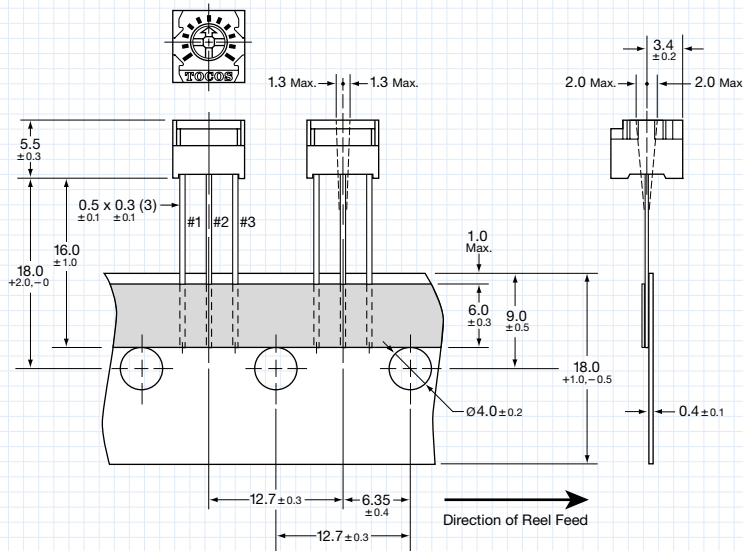

ST, ST2, XT2 (XT not available)

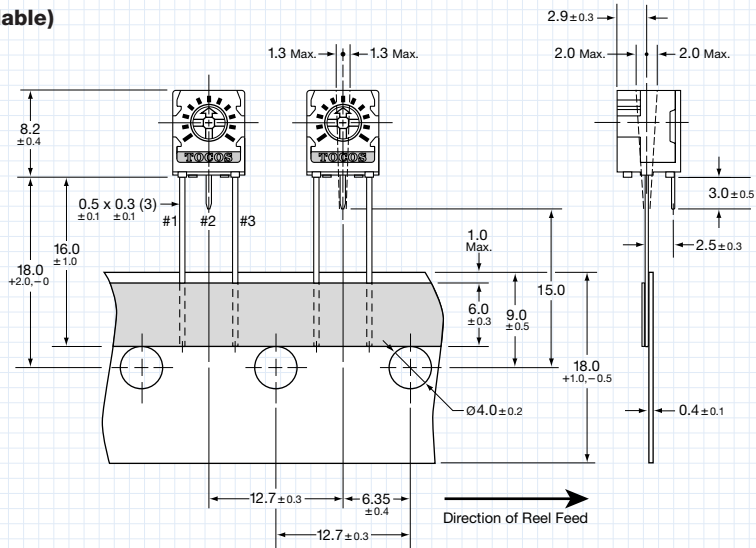

Tape Dimensions

Conforms to EIA-468-B and JIS-C-0805

S1T, S1T2

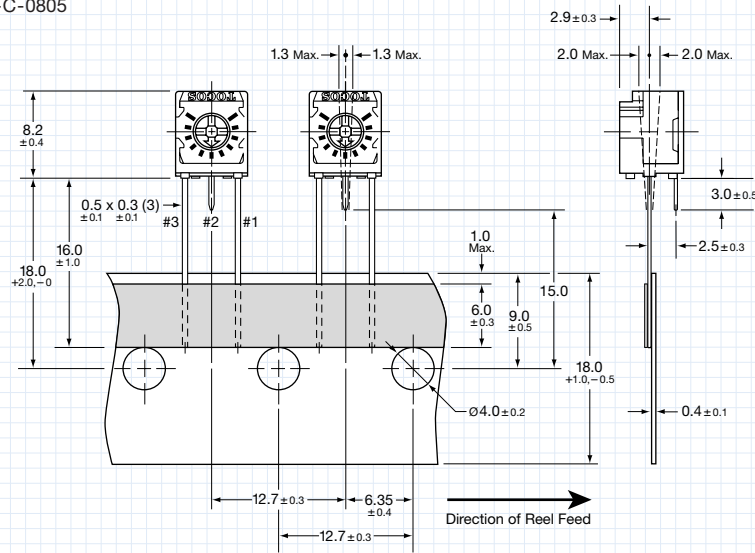

X1T2 (X1T not available)

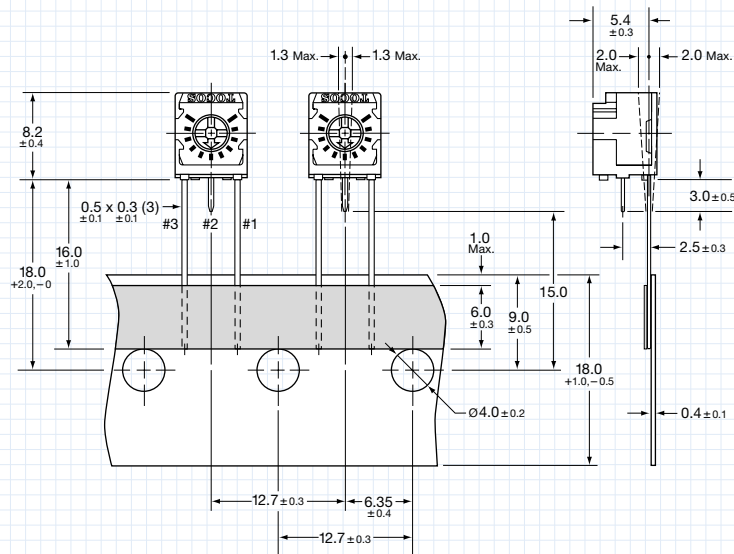

VT, VT2

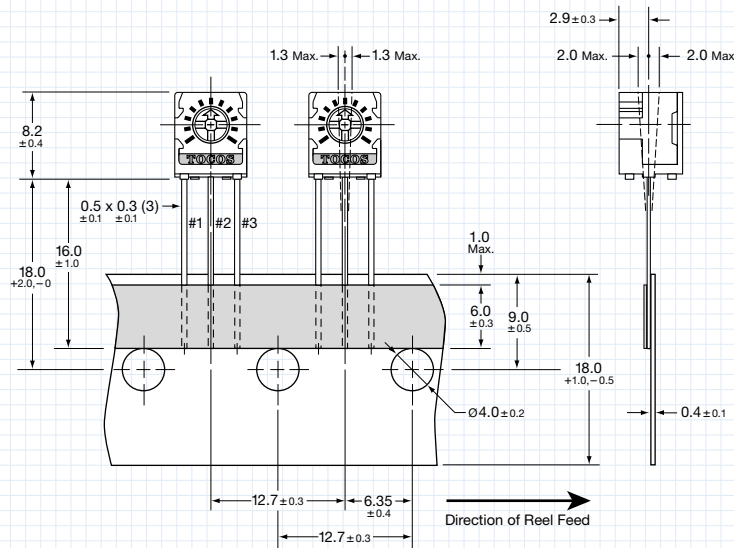

Tape Dimensions

Conforms to EIA-468-B and JIS-C-0805

V1T, V1T2

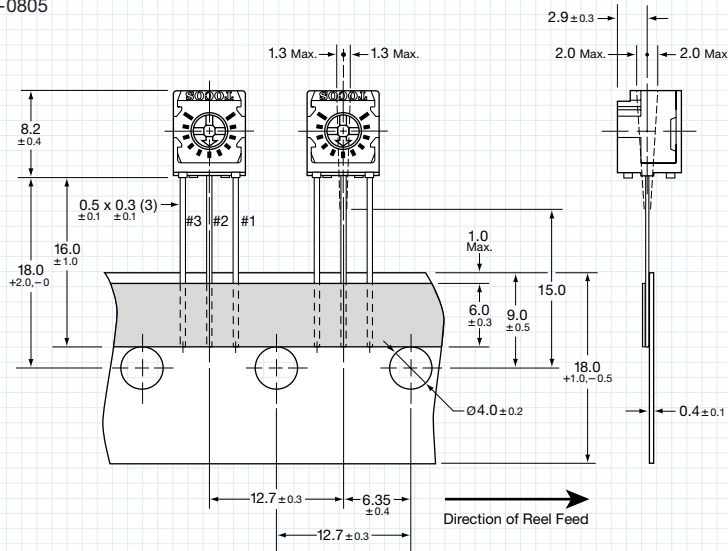

Reel Dimensions

Conforms to EIA-468-B and JIS-C-0805

PT, P1T, UT, ST, S1T, VT, V1T

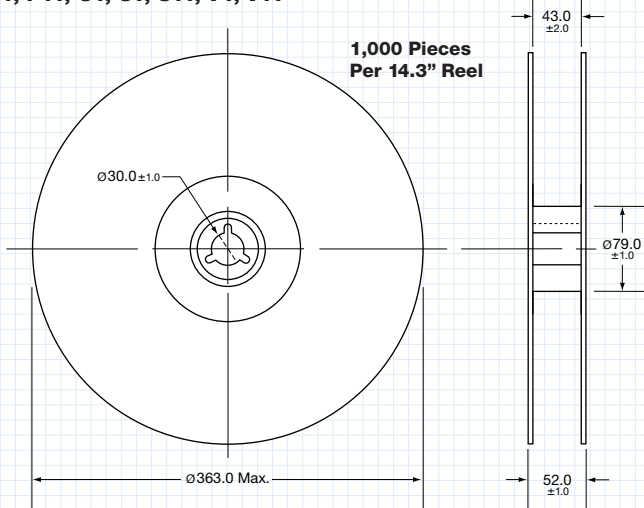

Ammo Box Dimensions

Conforms to EIA-468-B and JIS-C-0805

PT2, P1T2, UT2, ST2, S1T2, XT2, X1T2, VT2, V1T2

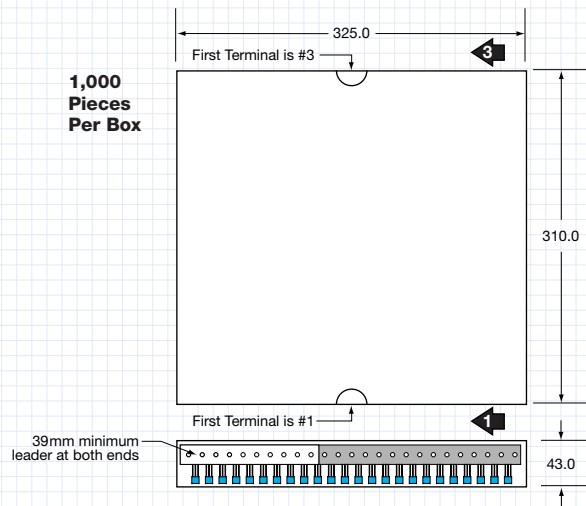

Part Numbering System

GF063 P1 T2 B 102 K

- Resistance Tolerance: K = ±10%; M = ±20%
- Resistance Code: Expressed in ohms. A three digit code where the first two digits are significant figures, and the third digit indicates the number of zeros that follow these figures (i.e., 100 = 10Ω; 101 = 100Ω; 102 = 1,000Ω; 105 = 1,000,000Ω).
- Resistance Taper: B = Linear.
- Packaging: T = Tape & Reel; T2 = Tape & Ammo Box; Blank = Bulk.
- Terminal Style: P, P1, P2, W, U, U1, Y, Y1 = 3-Lead Configurations, Top Adjust.
S, S1, X, X1, V, V1 = 3-Lead Configurations, Side Adjust.
P1-3 = Special Option, 3mm Leads, Top Adjust.
P1-LM = Special Option, 6.5mm Leads, Top Adjust.
U-LL = Special Option, 16mm Leads, Top Adjust.
V-3 = Special Option, 3mm Leads, Side Adjust.
- TOCOS Series Name.

Nominal Resistance		Resistance Tolerance: K = ±10% (see footnote for M = ±20%)			Potentiometer Styles
Value (Ω)	Code	Catalog No.* Tape & Reel	Catalog No.* Tape & Ammo Box	Catalog No.* Bulk	

GF063P Through-Hole, P Terminal Style, Cross-Slot, Top Adjust

10	100	GF063PT B 100 K	GF063PT2 B 100 K	GF063P B 100 K
20	200	GF063PT B 200 K	GF063PT2 B 200 K	GF063P B 200 K
50	500	GF063PT B 500 K	GF063PT2 B 500 K	GF063P B 500 K
100	101	GF063PT B 101 K	GF063PT2 B 101 K	GF063P B 101 K
200	201	GF063PT B 201 K	GF063PT2 B 201 K	GF063P B 201 K
500	501	GF063PT B 501 K	GF063PT2 B 501 K	GF063P B 501 K
1,000	102	GF063PT B 102 K	GF063PT2 B 102 K	GF063P B 102 K
2,000	202	GF063PT B 202 K	GF063PT2 B 202 K	GF063P B 202 K
5,000	502	GF063PT B 502 K	GF063PT2 B 502 K	GF063P B 502 K
10,000	103	GF063PT B 103 K	GF063PT2 B 103 K	GF063P B 103 K
20,000	203	GF063PT B 203 K	GF063PT2 B 203 K	GF063P B 203 K
50,000	503	GF063PT B 503 K	GF063PT2 B 503 K	GF063P B 503 K
100,000	104	GF063PT B 104 K	GF063PT2 B 104 K	GF063P B 104 K
200,000	204	GF063PT B 204 K	GF063PT2 B 204 K	GF063P B 204 K
500,000	504	GF063PT B 504 K	GF063PT2 B 504 K	GF063P B 504 K
1,000,000	105	GF063PT B 105 K	GF063PT2 B 105 K	GF063P B 105 K
2,000,000	205	GF063PT B 205 K	GF063PT2 B 205 K	GF063P B 205 K
5,000,000	505	GF063PT B 505 K	GF063PT2 B 505 K	GF063P B 505 K



GF063P

GF063P1 Through-Hole, P1 Terminal Style, Cross-Slot, Top Adjust

10	100	GF063P1T B 100 K	GF063P1T2 B 100 K	GF063P1 B 100 K
20	200	GF063P1T B 200 K	GF063P1T2 B 200 K	GF063P1 B 200 K
50	500	GF063P1T B 500 K	GF063P1T2 B 500 K	GF063P1 B 500 K
100	101	GF063P1T B 101 K	GF063P1T2 B 101 K	GF063P1 B 101 K
200	201	GF063P1T B 201 K	GF063P1T2 B 201 K	GF063P1 B 201 K
500	501	GF063P1T B 501 K	GF063P1T2 B 501 K	GF063P1 B 501 K
1,000	102	GF063P1T B 102 K	GF063P1T2 B 102 K	GF063P1 B 102 K
2,000	202	GF063P1T B 202 K	GF063P1T2 B 202 K	GF063P1 B 202 K
5,000	502	GF063P1T B 502 K	GF063P1T2 B 502 K	GF063P1 B 502 K
10,000	103	GF063P1T B 103 K	GF063P1T2 B 103 K	GF063P1 B 103 K
20,000	203	GF063P1T B 203 K	GF063P1T2 B 203 K	GF063P1 B 203 K
50,000	503	GF063P1T B 503 K	GF063P1T2 B 503 K	GF063P1 B 503 K
100,000	104	GF063P1T B 104 K	GF063P1T2 B 104 K	GF063P1 B 104 K
200,000	204	GF063P1T B 204 K	GF063P1T2 B 204 K	GF063P1 B 204 K
500,000	504	GF063P1T B 504 K	GF063P1T2 B 504 K	GF063P1 B 504 K
1,000,000	105	GF063P1T B 105 K	GF063P1T2 B 105 K	GF063P1 B 105 K
2,000,000	205	GF063P1T B 205 K	GF063P1T2 B 205 K	GF063P1 B 205 K
5,000,000	505	GF063P1T B 505 K	GF063P1T2 B 505 K	GF063P1 B 505 K



GF063P1

GF063P2 Through-Hole, P2 Terminal Style, Cross-Slot, Top Adjust

10	100	—	—	GF063P2 B 100 K
20	200	—	—	GF063P2 B 200 K
50	500	—	—	GF063P2 B 500 K
100	101	—	—	GF063P2 B 101 K
200	201	—	—	GF063P2 B 201 K
500	501	—	—	GF063P2 B 501 K
1,000	102	—	—	GF063P2 B 102 K
2,000	202	—	—	GF063P2 B 202 K
5,000	502	—	—	GF063P2 B 502 K
10,000	103	—	—	GF063P2 B 103 K
20,000	203	—	—	GF063P2 B 203 K
50,000	503	—	—	GF063P2 B 503 K
100,000	104	—	—	GF063P2 B 104 K
200,000	204	—	—	GF063P2 B 204 K
500,000	504	—	—	GF063P2 B 504 K
1,000,000	105	—	—	GF063P2 B 105 K
2,000,000	205	—	—	GF063P2 B 205 K
5,000,000	505	—	—	GF063P2 B 505 K



GF063P2

*Substitute code letter M in place of K at end of catalog part number for ±20% resistance tolerance.

Nominal Resistance		Resistance Tolerance: K = ±10% (see footnote for M = ±20%)			Potentiometer Styles
Value (Ω)	Code	Catalog No.* Tape & Reel	Catalog No.* Tape & Ammo Box	Catalog No.* Bulk	

GF063W Through-Hole, W Terminal Style, Cross-Slot, Top Adjust

10	100	—	—	GF063W B 100 K
20	200	—	—	GF063W B 200 K
50	500	—	—	GF063W B 500 K
100	101	—	—	GF063W B 101 K
200	201	—	—	GF063W B 201 K
500	501	—	—	GF063W B 501 K
1,000	102	—	—	GF063W B 102 K
2,000	202	—	—	GF063W B 202 K
5,000	502	—	—	GF063W B 502 K
10,000	103	—	—	GF063W B 103 K
20,000	203	—	—	GF063W B 203 K
50,000	503	—	—	GF063W B 503 K
100,000	104	—	—	GF063W B 104 K
200,000	204	—	—	GF063W B 204 K
500,000	504	—	—	GF063W B 504 K
1,000,000	105	—	—	GF063W B 105 K
2,000,000	205	—	—	GF063W B 205 K
5,000,000	505	—	—	GF063W B 505 K



GF063W

GF063U Through-Hole, U Terminal Style, Cross-Slot, Top Adjust

10	100	GF063UT B 100 K	GF063UT2 B 100 K	GF063U B 100 K
20	200	GF063UT B 200 K	GF063UT2 B 200 K	GF063U B 200 K
50	500	GF063UT B 500 K	GF063UT2 B 500 K	GF063U B 500 K
100	101	GF063UT B 101 K	GF063UT2 B 101 K	GF063U B 101 K
200	201	GF063UT B 201 K	GF063UT2 B 201 K	GF063U B 201 K
500	501	GF063UT B 501 K	GF063UT2 B 501 K	GF063U B 501 K
1,000	102	GF063UT B 102 K	GF063UT2 B 102 K	GF063U B 102 K
2,000	202	GF063UT B 202 K	GF063UT2 B 202 K	GF063U B 202 K
5,000	502	GF063UT B 502 K	GF063UT2 B 502 K	GF063U B 502 K
10,000	103	GF063UT B 103 K	GF063UT2 B 103 K	GF063U B 103 K
20,000	203	GF063UT B 203 K	GF063UT2 B 203 K	GF063U B 203 K
50,000	503	GF063UT B 503 K	GF063UT2 B 503 K	GF063U B 503 K
100,000	104	GF063UT B 104 K	GF063UT2 B 104 K	GF063U B 104 K
200,000	204	GF063UT B 204 K	GF063UT2 B 204 K	GF063U B 204 K
500,000	504	GF063UT B 504 K	GF063UT2 B 504 K	GF063U B 504 K
1,000,000	105	GF063UT B 105 K	GF063UT2 B 105 K	GF063U B 105 K
2,000,000	205	GF063UT B 205 K	GF063UT2 B 205 K	GF063U B 205 K
5,000,000	505	GF063UT B 505 K	GF063UT2 B 505 K	GF063U B 505 K



GF063U

GF063U1 Through-Hole, U1 Terminal Style, Cross-Slot, Top Adjust

10	100	—	—	GF063U1 B 100 K
20	200	—	—	GF063U1 B 200 K
50	500	—	—	GF063U1 B 500 K
100	101	—	—	GF063U1 B 101 K
200	201	—	—	GF063U1 B 201 K
500	501	—	—	GF063U1 B 501 K
1,000	102	—	—	GF063U1 B 102 K
2,000	202	—	—	GF063U1 B 202 K
5,000	502	—	—	GF063U1 B 502 K
10,000	103	—	—	GF063U1 B 103 K
20,000	203	—	—	GF063U1 B 203 K
50,000	503	—	—	GF063U1 B 503 K
100,000	104	—	—	GF063U1 B 104 K
200,000	204	—	—	GF063U1 B 204 K
500,000	504	—	—	GF063U1 B 504 K
1,000,000	105	—	—	GF063U1 B 105 K
2,000,000	205	—	—	GF063U1 B 205 K
5,000,000	505	—	—	GF063U1 B 505 K



GF063U1

*Substitute code letter M in place of K at end of catalog part number for ±20% resistance tolerance.

Nominal Resistance		Resistance Tolerance: K = ±10% (see footnote for M = ±20%)			Potentiometer Styles
Value (Ω)	Code	Catalog No.* Tape & Reel	Catalog No.* Tape & Ammo Box	Catalog No.* Bulk	

GF063Y Through-Hole, Y Terminal Style, Cross-Slot, Top Adjust

10	100	—	—	GF063Y B 100 K
20	200	—	—	GF063Y B 200 K
50	500	—	—	GF063Y B 500 K
100	101	—	—	GF063Y B 101 K
200	201	—	—	GF063Y B 201 K
500	501	—	—	GF063Y B 501 K
1,000	102	—	—	GF063Y B 102 K
2,000	202	—	—	GF063Y B 202 K
5,000	502	—	—	GF063Y B 502 K
10,000	103	—	—	GF063Y B 103 K
20,000	203	—	—	GF063Y B 203 K
50,000	503	—	—	GF063Y B 503 K
100,000	104	—	—	GF063Y B 104 K
200,000	204	—	—	GF063Y B 204 K
500,000	504	—	—	GF063Y B 504 K
1,000,000	105	—	—	GF063Y B 105 K
2,000,000	205	—	—	GF063Y B 205 K
5,000,000	505	—	—	GF063Y B 505 K



GF063Y

GF063Y1 Through-Hole, Y1 Terminal Style, Cross-Slot, Top Adjust

10	100	—	—	GF063Y1 B 100 K
20	200	—	—	GF063Y1 B 200 K
50	500	—	—	GF063Y1 B 500 K
100	101	—	—	GF063Y1 B 101 K
200	201	—	—	GF063Y1 B 201 K
500	501	—	—	GF063Y1 B 501 K
1,000	102	—	—	GF063Y1 B 102 K
2,000	202	—	—	GF063Y1 B 202 K
5,000	502	—	—	GF063Y1 B 502 K
10,000	103	—	—	GF063Y1 B 103 K
20,000	203	—	—	GF063Y1 B 203 K
50,000	503	—	—	GF063Y1 B 503 K
100,000	104	—	—	GF063Y1 B 104 K
200,000	204	—	—	GF063Y1 B 204 K
500,000	504	—	—	GF063Y1 B 504 K
1,000,000	105	—	—	GF063Y1 B 105 K
2,000,000	205	—	—	GF063Y1 B 205 K
5,000,000	505	—	—	GF063Y1 B 505 K



GF063Y1

GF063S Through-Hole, S Terminal Style, Cross-Slot, Side Adjust

10	100	GF063ST B 100 K	GF063ST2 B 100 K	GF063S B 100 K
20	200	GF063ST B 200 K	GF063ST2 B 200 K	GF063S B 200 K
50	500	GF063ST B 500 K	GF063ST2 B 500 K	GF063S B 500 K
100	101	GF063ST B 101 K	GF063ST2 B 101 K	GF063S B 101 K
200	201	GF063ST B 201 K	GF063ST2 B 201 K	GF063S B 201 K
500	501	GF063ST B 501 K	GF063ST2 B 501 K	GF063S B 501 K
1,000	102	GF063ST B 102 K	GF063ST2 B 102 K	GF063S B 102 K
2,000	202	GF063ST B 202 K	GF063ST2 B 202 K	GF063S B 202 K
5,000	502	GF063ST B 502 K	GF063ST2 B 502 K	GF063S B 502 K
10,000	103	GF063ST B 103 K	GF063ST2 B 103 K	GF063S B 103 K
20,000	203	GF063ST B 203 K	GF063ST2 B 203 K	GF063S B 203 K
50,000	503	GF063ST B 503 K	GF063ST2 B 503 K	GF063S B 503 K
100,000	104	GF063ST B 104 K	GF063ST2 B 104 K	GF063S B 104 K
200,000	204	GF063ST B 204 K	GF063ST2 B 204 K	GF063S B 204 K
500,000	504	GF063ST B 504 K	GF063ST2 B 504 K	GF063S B 504 K
1,000,000	105	GF063ST B 105 K	GF063ST2 B 105 K	GF063S B 105 K
2,000,000	205	GF063ST B 205 K	GF063ST2 B 205 K	GF063S B 205 K
5,000,000	505	GF063ST B 505 K	GF063ST2 B 505 K	GF063S B 505 K



GF063S

*Substitute code letter M in place of K at end of catalog part number for ±20% resistance tolerance.

Nominal Resistance		Resistance Tolerance: K = ±10% (see footnote for M = ±20%)			Potentiometer Styles
Value (Ω)	Code	Catalog No.* Tape & Reel	Catalog No.* Tape & Ammo Box	Catalog No.* Bulk	

GF063S1 Through-Hole, S1 Terminal Style, Cross-Slot, Side Adjust

10	100	GF063S1T B 100 K	GF063S1T2 B 100 K	GF063S1 B 100 K
20	200	GF063S1T B 200 K	GF063S1T2 B 200 K	GF063S1 B 200 K
50	500	GF063S1T B 500 K	GF063S1T2 B 500 K	GF063S1 B 500 K
100	101	GF063S1T B 101 K	GF063S1T2 B 101 K	GF063S1 B 101 K
200	201	GF063S1T B 201 K	GF063S1T2 B 201 K	GF063S1 B 201 K
500	501	GF063S1T B 501 K	GF063S1T2 B 501 K	GF063S1 B 501 K
1,000	102	GF063S1T B 102 K	GF063S1T2 B 102 K	GF063S1 B 102 K
2,000	202	GF063S1T B 202 K	GF063S1T2 B 202 K	GF063S1 B 202 K
5,000	502	GF063S1T B 502 K	GF063S1T2 B 502 K	GF063S1 B 502 K
10,000	103	GF063S1T B 103 K	GF063S1T2 B 103 K	GF063S1 B 103 K
20,000	203	GF063S1T B 203 K	GF063S1T2 B 203 K	GF063S1 B 203 K
50,000	503	GF063S1T B 503 K	GF063S1T2 B 503 K	GF063S1 B 503 K
100,000	104	GF063S1T B 104 K	GF063S1T2 B 104 K	GF063S1 B 104 K
200,000	204	GF063S1T B 204 K	GF063S1T2 B 204 K	GF063S1 B 204 K
500,000	504	GF063S1T B 504 K	GF063S1T2 B 504 K	GF063S1 B 504 K
1,000,000	105	GF063S1T B 105 K	GF063S1T2 B 105 K	GF063S1 B 105 K
2,000,000	205	GF063S1T B 205 K	GF063S1T2 B 205 K	GF063S1 B 205 K
5,000,000	505	GF063S1T B 505 K	GF063S1T2 B 505 K	GF063S1 B 505 K



GF063S1

GF063X Through-Hole, X Terminal Style, Cross-Slot, Side Adjust

10	100	—	GF063XT2 B 100 K	GF063X B 100 K
20	200	—	GF063XT2 B 200 K	GF063X B 200 K
50	500	—	GF063XT2 B 500 K	GF063X B 500 K
100	101	—	GF063XT2 B 101 K	GF063X B 101 K
200	201	—	GF063XT2 B 201 K	GF063X B 201 K
500	501	—	GF063XT2 B 501 K	GF063X B 501 K
1,000	102	—	GF063XT2 B 102 K	GF063X B 102 K
2,000	202	—	GF063XT2 B 202 K	GF063X B 202 K
5,000	502	—	GF063XT2 B 502 K	GF063X B 502 K
10,000	103	—	GF063XT2 B 103 K	GF063X B 103 K
20,000	203	—	GF063XT2 B 203 K	GF063X B 203 K
50,000	503	—	GF063XT2 B 503 K	GF063X B 503 K
100,000	104	—	GF063XT2 B 104 K	GF063X B 104 K
200,000	204	—	GF063XT2 B 204 K	GF063X B 204 K
500,000	504	—	GF063XT2 B 504 K	GF063X B 504 K
1,000,000	105	—	GF063XT2 B 105 K	GF063X B 105 K
2,000,000	205	—	GF063XT2 B 205 K	GF063X B 205 K
5,000,000	505	—	GF063XT2 B 505 K	GF063X B 505 K



GF063X

GF063X1 Through-Hole, X1 Terminal Style, Cross-Slot, Side Adjust

10	100	—	GF063X1T2 B 100 K	GF063X1 B 100 K
20	200	—	GF063X1T2 B 200 K	GF063X1 B 200 K
50	500	—	GF063X1T2 B 500 K	GF063X1 B 500 K
100	101	—	GF063X1T2 B 101 K	GF063X1 B 101 K
200	201	—	GF063X1T2 B 201 K	GF063X1 B 201 K
500	501	—	GF063X1T2 B 501 K	GF063X1 B 501 K
1,000	102	—	GF063X1T2 B 102 K	GF063X1 B 102 K
2,000	202	—	GF063X1T2 B 202 K	GF063X1 B 202 K
5,000	502	—	GF063X1T2 B 502 K	GF063X1 B 502 K
10,000	103	—	GF063X1T2 B 103 K	GF063X1 B 103 K
20,000	203	—	GF063X1T2 B 203 K	GF063X1 B 203 K
50,000	503	—	GF063X1T2 B 503 K	GF063X1 B 503 K
100,000	104	—	GF063X1T2 B 104 K	GF063X1 B 104 K
200,000	204	—	GF063X1T2 B 204 K	GF063X1 B 204 K
500,000	504	—	GF063X1T2 B 504 K	GF063X1 B 504 K
1,000,000	105	—	GF063X1T2 B 105 K	GF063X1 B 105 K
2,000,000	205	—	GF063X1T2 B 205 K	GF063X1 B 205 K
5,000,000	505	—	GF063X1T2 B 505 K	GF063X1 B 505 K



GF063X1

*Substitute code letter M in place of K at end of catalog part number for ±20% resistance tolerance.

Nominal Resistance		Resistance Tolerance: K = ±10% (see footnote for M = ±20%)			Potentiometer Styles
Value (Ω)	Code	Catalog No.* Tape & Reel	Catalog No.* Tape & Ammo Box	Catalog No.* Bulk	

GF063V Through-Hole, V Terminal Style, Cross-Slot, Side Adjust

10	100	GF063VT B 100 K	GF063VT2 B 100 K	GF063V B 100 K
20	200	GF063VT B 200 K	GF063VT2 B 200 K	GF063V B 200 K
50	500	GF063VT B 500 K	GF063VT2 B 500 K	GF063V B 500 K
100	101	GF063VT B 101 K	GF063VT2 B 101 K	GF063V B 101 K
200	201	GF063VT B 201 K	GF063VT2 B 201 K	GF063V B 201 K
500	501	GF063VT B 501 K	GF063VT2 B 501 K	GF063V B 501 K
1,000	102	GF063VT B 102 K	GF063VT2 B 102 K	GF063V B 102 K
2,000	202	GF063VT B 202 K	GF063VT2 B 202 K	GF063V B 202 K
5,000	502	GF063VT B 502 K	GF063VT2 B 502 K	GF063V B 502 K
10,000	103	GF063VT B 103 K	GF063VT2 B 103 K	GF063V B 103 K
20,000	203	GF063VT B 203 K	GF063VT2 B 203 K	GF063V B 203 K
50,000	503	GF063VT B 503 K	GF063VT2 B 503 K	GF063V B 503 K
100,000	104	GF063VT B 104 K	GF063VT2 B 104 K	GF063V B 104 K
200,000	204	GF063VT B 204 K	GF063VT2 B 204 K	GF063V B 204 K
500,000	504	GF063VT B 504 K	GF063VT2 B 504 K	GF063V B 504 K
1,000,000	105	GF063VT B 105 K	GF063VT2 B 105 K	GF063V B 105 K
2,000,000	205	GF063VT B 205 K	GF063VT2 B 205 K	GF063V B 205 K
5,000,000	505	GF063VT B 505 K	GF063VT2 B 505 K	GF063V B 505 K



GF063V

GF063V1 Through-Hole, V1 Terminal Style, Cross-Slot, Side Adjust

10	100	GF063V1T B 100 K	GF063V1T2 B 100 K	GF063V1 B 100 K
20	200	GF063V1T B 200 K	GF063V1T2 B 200 K	GF063V1 B 200 K
50	500	GF063V1T B 500 K	GF063V1T2 B 500 K	GF063V1 B 500 K
100	101	GF063V1T B 101 K	GF063V1T2 B 101 K	GF063V1 B 101 K
200	201	GF063V1T B 201 K	GF063V1T2 B 201 K	GF063V1 B 201 K
500	501	GF063V1T B 501 K	GF063V1T2 B 501 K	GF063V1 B 501 K
1,000	102	GF063V1T B 102 K	GF063V1T2 B 102 K	GF063V1 B 102 K
2,000	202	GF063V1T B 202 K	GF063V1T2 B 202 K	GF063V1 B 202 K
5,000	502	GF063V1T B 502 K	GF063V1T2 B 502 K	GF063V1 B 502 K
10,000	103	GF063V1T B 103 K	GF063V1T2 B 103 K	GF063V1 B 103 K
20,000	203	GF063V1T B 203 K	GF063V1T2 B 203 K	GF063V1 B 203 K
50,000	503	GF063V1T B 503 K	GF063V1T2 B 503 K	GF063V1 B 503 K
100,000	104	GF063V1T B 104 K	GF063V1T2 B 104 K	GF063V1 B 104 K
200,000	204	GF063V1T B 204 K	GF063V1T2 B 204 K	GF063V1 B 204 K
500,000	504	GF063V1T B 504 K	GF063V1T2 B 504 K	GF063V1 B 504 K
1,000,000	105	GF063V1T B 105 K	GF063V1T2 B 105 K	GF063V1 B 105 K
2,000,000	205	GF063V1T B 205 K	GF063V1T2 B 205 K	GF063V1 B 205 K
5,000,000	505	GF063V1T B 505 K	GF063V1T2 B 505 K	GF063V1 B 505 K



GF063V1

*Substitute code letter M in place of K at end of catalog part number for ±20% resistance tolerance.

Packaging

Standard:

Tape & Reel Packaging

PT, P1T, UT, ST, S1T, VT, V1T
1,000 pieces per 14.3" reel.

Tape & Ammo Packaging

PT2, P1T2, UT2, ST2, S1T2, XT2, X1T2, VT2, V1T2
1,000 pieces per ammo box.

Bulk Packaging

All GF063 Models
50 pieces per vinyl bag.
500 pieces per box.

Soldering and Cleaning Guidelines

For soldering, cleaning and other information, refer to Guidelines and Precautions for Using Potentiometers.