

### ■ Features :

- Universal AC input / Full range (up to 305VAC)
- Built-in active PFC function
- Protections: Short circuit / Over current / Over voltage / Over temperature
- Cooling by free air convection
- Output constant current level adjustable
- Class 2 power unit
- Three in one dimming function (1~10Vdc or PWM signal or resistance)
- Suitable for built in LED lighting system
- Suitable for dry / damp locations
- 100% full load burn-in test
- 3 years warranty



### SPECIFICATION

MODEL	HLP-60H-15	HLP-60H-20	HLP-60H-24	HLP-60H-30	HLP-60H-36	HLP-60H-42	HLP-60H-48	HLP-60H-54		
OUTPUT	DC VOLTAGE	15V	20V	24V	30V	36V	42V	48V	54V	
	CONSTANT CURRENT REGION <small>Note.4</small>	9 ~ 15V	12 ~ 20V	14.4 ~ 24V	18 ~ 30V	21.6 ~ 36V	25.2 ~ 42V	28.8 ~ 48V	32.4 ~ 54V	
	RATED CURRENT	4A	3A	2.5A	2A	1.7A	1.45A	1.3A	1.15A	
	RATED POWER	60W	60W	60W	60W	61.2W	60.9W	62.4W	62.1W	
	RIPPLE & NOISE (max.) <small>Note.2</small>	150mVp-p	150mVp-p	150mVp-p	200mVp-p	200mVp-p	300mVp-p	300mVp-p	300mVp-p	
	VOLTAGE ADJ. RANGE	13.5 ~ 17V	17 ~ 22V	22 ~ 27V	27 ~ 33V	33 ~ 40V	40 ~ 46V	44 ~ 53V	49 ~ 58V	
	CURRENT ADJ. RANGE	Can be adjusted by internal potentiometer								
		2.4 ~ 4A	1.8 ~ 3A	1.5 ~ 2.5A	1.2 ~ 2A	1 ~ 1.7A	0.87 ~ 1.45A	0.78 ~ 1.3A	0.69 ~ 1.15A	
	VOLTAGE TOLERANCE <small>Note.3</small>	±2.0%	±1.0%	±1.0%	±1.0%	±1.0%	±1.0%	±1.0%	±1.0%	
	LINE REGULATION	±0.5%	±0.5%	±0.5%	±0.5%	±0.5%	±0.5%	±0.5%	±0.5%	
	LOAD REGULATION	±1.5%	±1.0%	±0.5%	±0.5%	±0.5%	±0.5%	±0.5%	±0.5%	
SETUP, RISE TIME <small>Note.6</small>	500ms, 80ms at full load 230VAC / 115VAC									
HOLD UP TIME (Typ.)	16ms/230VAC 16ms/115VAC at full load									
INPUT	VOLTAGE RANGE <small>Note.5</small>	90 ~ 305VAC		127 ~ 431VDC						
	FREQUENCY RANGE	47 ~ 63Hz								
	POWER FACTOR (Typ.)	PF>0.98/115VAC, PF>0.95/230VAC, PF>0.92/277VAC at full load (Please refer to "Power Factor Characteristic" curve)								
	TOTAL HARMONIC DISTORTION	THD< 20% when output loading≥60% at 115VAC/230VAC input and output loading≥75% at 277VAC input								
	EFFICIENCY (Typ.)	88%	89%	89.5%	90%	90%	90%	90.5%	90.5%	
	AC CURRENT (Typ.)	0.64A / 115VAC		0.32A / 230VAC		0.3A / 277VAC				
	INRUSH CURRENT (Typ.)	COLD START 55A(twidth=265μs measured at 50% Ipeak) at 230VAC								
	MAX. No. of PSUs on 16A CIRCUIT BREAKER	9 units (circuit breaker of type B) / 16 units (circuit breaker of type C) at 230VAC								
LEAKAGE CURRENT	<0.75mA / 277VAC									
PROTECTION	OVER CURRENT <small>Note.4</small>	95 ~ 108% Protection type : Constant current limiting, recovers automatically after fault condition is removed								
	SHORT CIRCUIT	Hiccup mode, recovers automatically after fault condition is removed								
	OVER VOLTAGE	18 ~ 24V	23 ~ 30V	28 ~ 35V	35 ~ 43V	41 ~ 49V	48 ~ 58V	54 ~ 65V	59 ~ 68V	
		Protection type : Shut down o/p voltage, re-power on to recover								
OVER TEMPERATURE	Shut down o/p voltage, re-power on to recover									
ENVIRONMENT	WORKING TEMP.	-40 ~ +70°C (Refer to "Derating Curve")								
	WORKING HUMIDITY	20 ~ 95% RH non-condensing								
	STORAGE TEMP., HUMIDITY	-40 ~ +80°C, 10 ~ 95% RH								
	TEMP. COEFFICIENT	±0.03%/°C (0 ~ 50°C)								
VIBRATION	10 ~ 500Hz, 2G 12min./1cycle, period for 72min. each along X, Y, Z axes									
SAFETY & EMC	SAFETY STANDARDS	UL8750, CSA C22.2 No. 250.0-08 (except for 48V, 54V), EN61347-1, EN61347-2-13, GB19510.14, GB19510.1, EAC TP TC 004 approved ; design refer to UL60950-1, TUV EN60950-1, EN60335-1								
	WITHSTAND VOLTAGE	I/P-O/P:3.75KVAC I/P-FG:2KVAC O/P-FG:0.5KVAC								
	ISOLATION RESISTANCE	I/P-O/P, I/P-FG, O/P-FG:100M Ohms / 500VDC / 25°C/ 70% RH								
	EMC EMISSION	Compliance to EN55015, GB17743, GB17625.1, EN61000-3-2 Class C (≥60% load) ; EN61000-3-3, EAC TP TC 020								
EMC IMMUNITY	Compliance to EN61000-4-2,3,4,5,6,8,11; EN61547, EN55024, light industry level (surge 4KV), criteria A, EAC TP TC 020									
OTHERS	MTBF	288.5Khrs min. MIL-HDBK-217F (25°C)								
	DIMENSION	147*53*27mm (L*W*H)								
	PACKING	0.2Kg:72pcs/15.4Kg/1.01CUFT								
NOTE	<ol style="list-style-type: none"> <li>All parameters NOT specially mentioned are measured at 230VAC input, rated load and 25°C of ambient temperature.</li> <li>Ripple &amp; noise are measured at 20MHz of bandwidth by using a 12" twisted pair-wire terminated with a 0.1uf &amp; 47uf parallel capacitor.</li> <li>Tolerance : includes set up tolerance, line regulation and load regulation.</li> <li>Please refer to "DRIVING METHODS OF LED MODULE".</li> <li>Derating may be needed under low input voltages. Please check the static characteristics for more details.</li> <li>Length of set up time is measured at cold first start. Turning ON/OFF the power supply may lead to increase of the set up time.</li> <li>The power supply is considered a component which will be installed into a final equipment. All the EMC tests are been executed by mounting the unit on a 360mm*360mm metal plate with 1mm of thickness. The final equipment must be re-confirmed that it still meets EMC directives. For guidance on how to perform these EMC tests, please refer to "EMI testing of component power supplies." (as available on <a href="http://www.meanwell.com">http://www.meanwell.com</a>)</li> <li>Direct connecting to LEDs is suggested, but is not suitable for using additional drivers.</li> <li>To fulfill requirements of the latest ErP regulation for lighting fixtures, this LED power supply can only be used behind a switch without permanently connected to the mains.</li> </ol>									

■ Mechanical Specification

Unit:mm

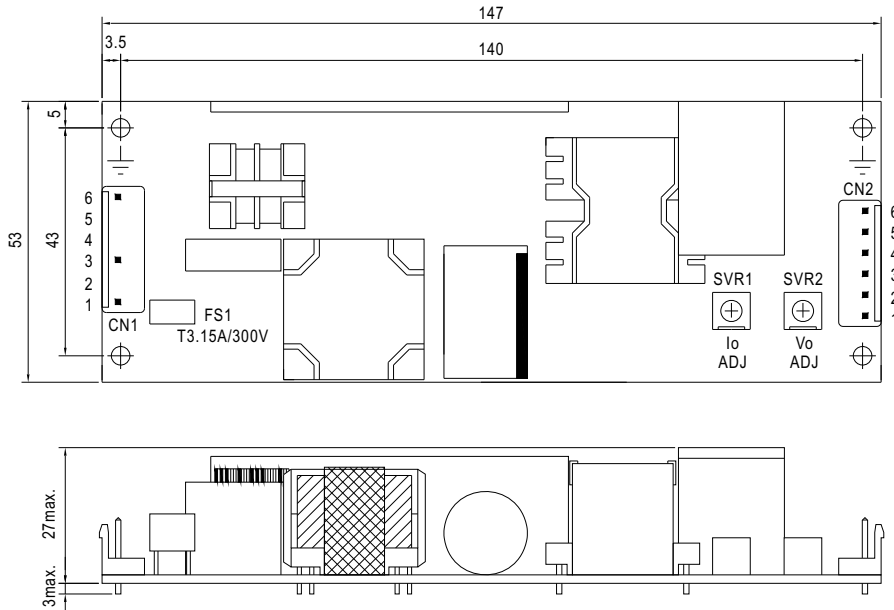

AC Input Connector (CN1) : JST B6P-VH or equivalent

Pin No.	Assignment	Mating Housing	Terminal
1	AC/L	JST VHR or equivalent	JST SVH-21T-P1.1 or equivalent
2,4,5	No Pin		
3	AC/N		
6	FG $\perp$		

DC Output Connector (CN2) : JST B6P-VH or equivalent

Pin No.	Assignment	Mating Housing	Terminal
1	DIM+	JST VHR or equivalent	JST SVH-21T-P1.1 or equivalent
2	DIM-		
3,4	-V		
5,6	+V		

$\perp$  : Grounding required

■ Block Diagram

fosc : 100KHz

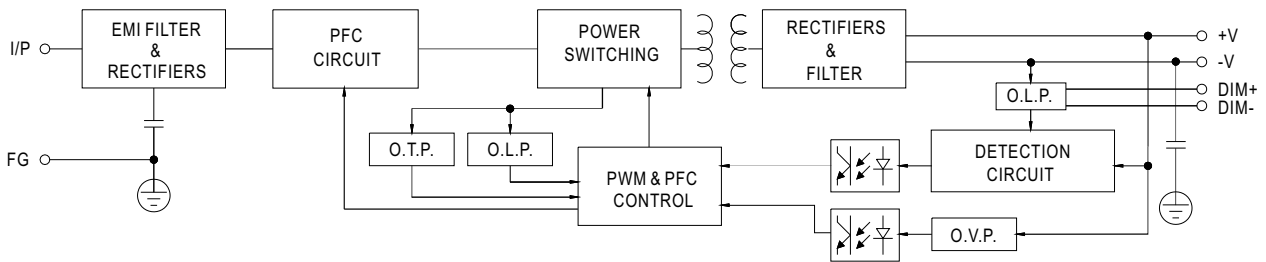

■ Derating Curve

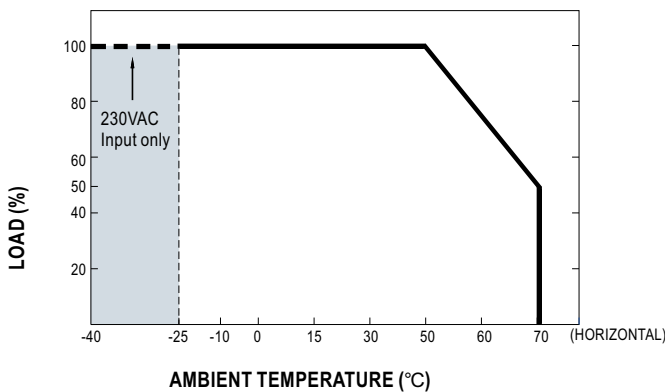

■ Static Characteristics

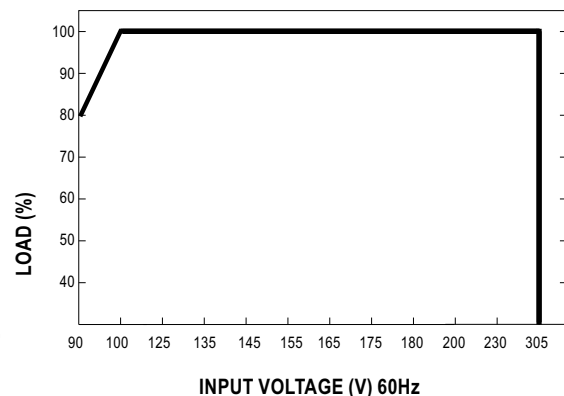

### Power Factor Characteristic

Constant Current Mode

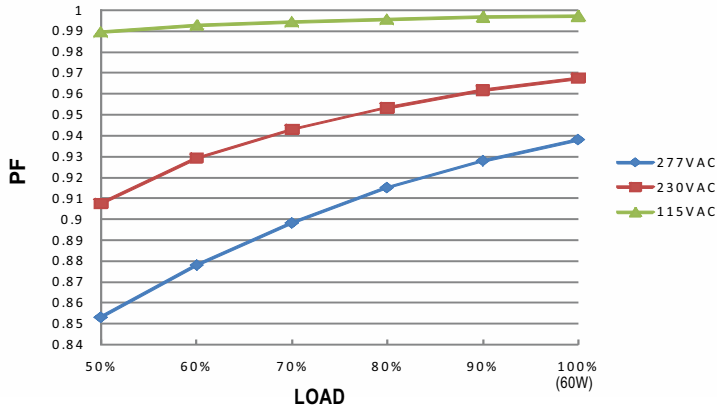

### EFFICIENCY vs LOAD (48V Model)

HLP-60H series possess superior working efficiency that up to 90.5% can be reached in field applications.

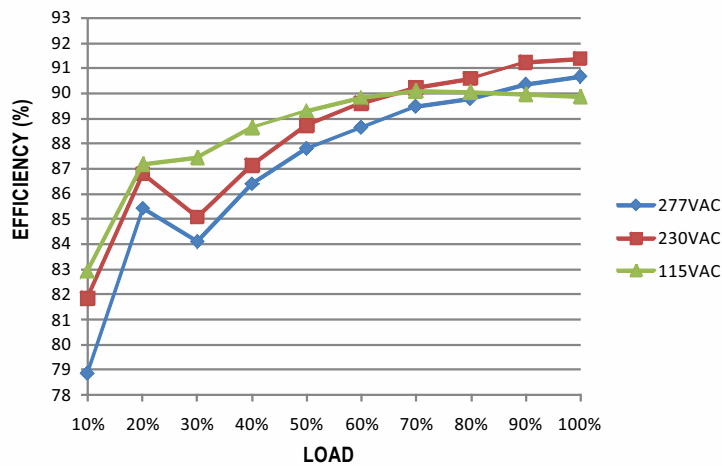

### DRIVING METHODS OF LED MODULE

This LED power supply is suggested to work in constant current mode area (CC) to drive the LEDs.

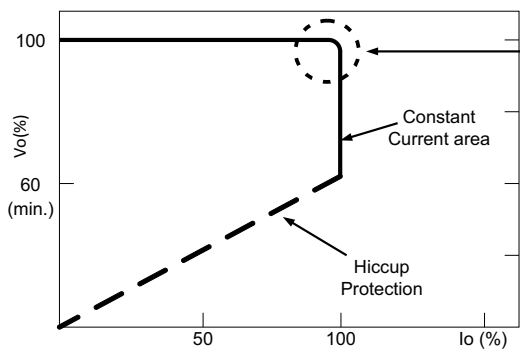

Typical LED power supply I-V curve

In the constant current region, the highest voltage at the output of the driver depends on the configuration of the end systems.

Should there be any compatibility issues, please contact MEAN WELL.

## ■ DIMMING OPERATION

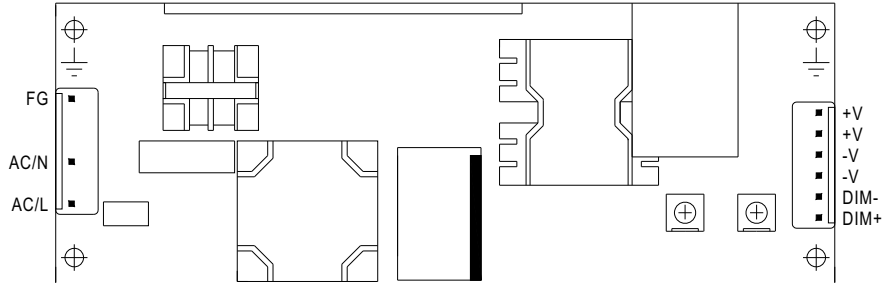

※ Output constant current level can be adjusted through output connector by 1~10VDC, PWM signal, or connecting a resistance between DIM+ and DIM-.

※ Please DO NOT connect "DIM-" to "-V".

※ Reference resistance value for output current adjustment (Typical)

Resistance value	Single driver	10KΩ	20KΩ	30KΩ	40KΩ	50KΩ	60KΩ	70KΩ	80KΩ	90KΩ	100KΩ	OPEN
		Multiple drivers (N=driver quantity for synchronized dimming operation)	10KΩ/N	20KΩ/N	30KΩ/N	40KΩ/N	50KΩ/N	60KΩ/N	70KΩ/N	80KΩ/N	90KΩ/N	100KΩ/N
Percentage of rated current		10%	20%	30%	40%	50%	60%	70%	80%	90%	100%	95%~108%

※ 1 ~ 10V dimming function for output current adjustment (Typical)

Dimming value	1V	2V	3V	4V	5V	6V	7V	8V	9V	10V	OPEN
Percentage of rated current	10%	20%	30%	40%	50%	60%	70%	80%	90%	100%	95%~108%

※ 10V PWM signal for output current adjustment (Typical): Frequency range : 100Hz ~ 3KHz

Duty value	10%	20%	30%	40%	50%	60%	70%	80%	90%	100%	OPEN
Percentage of rated current	10%	20%	30%	40%	50%	60%	70%	80%	90%	100%	95%~108%

※ Using the built-in dimming function can't turn the lighting fixture totally dark. Please refer to the connection method below to achieve 0% brightness of the lighting fixture connecting to the LED power supply unit.

Dimming connection diagram for turning the lighting fixture ON/OFF :

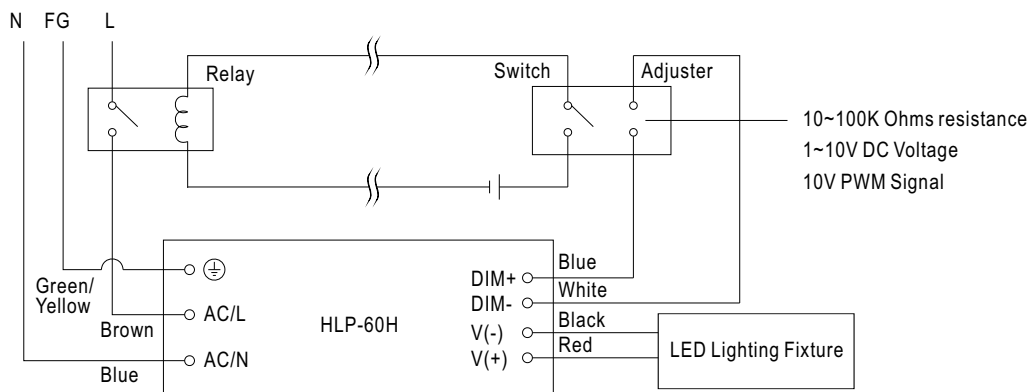

Using a switch and relay can turn ON/OFF the lighting fixture.

1. Output constant current level can be adjusted through output connector by connecting a resistance or 1~10Vdc or 10V PWM signal between DIM+ and DIM-.
2. The LED lighting fixture can be turned ON/OFF by the switch.