



Dimension

L	*	W	*	H	
295	*	127	*	41 (1U)	mm
11.6	*	5	*	1.61(1U)	inch



■ Features

- Universal AC input / Full range
- Built-in active PFC function
- High efficiency up to 92%
- Forced air cooling by built-in DC fan
- Output voltage programmable
- Active current sharing up to 8000W (3+1)
- Built-in remote ON-OFF control / remote sense / auxiliary power / DC OK signal / OTP alarm signal
- Protections: Short circuit / Overload / Over voltage / Over temperature
- Optional conformal coating
- 5 years warranty

■ Applications

- Factory control or automation apparatus
- Test and measurement instrument
- Laser related machine
- Burn-in facility
- Digital broadcasting
- RF application

■ Description

RSP-2000 is a 2KW single output enclosed type AC/DC power supply with 1U low profile. This series operates for 90~264VAC input voltage and offers the models with the DC output mostly demanded from the industry. Each model is cooled by the built-in fan with fan speed control, working for the temperature up to 70°C. Moreover, RSP-2000 provides vast design flexibility by equipping various built-in functions such as the output programming, active current sharing, remote ON-OFF control, auxiliary power, etc.

■ Model Encoding / Order Information

RSP - 2000 - 48

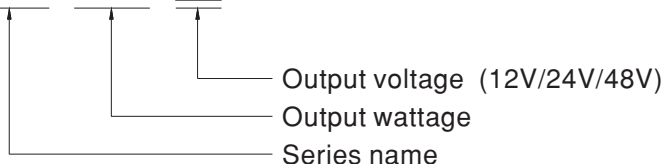

SPECIFICATION

MODEL		RSP-2000-12	RSP-2000-24	RSP-2000-48	
OUTPUT	DC VOLTAGE	12V	24V	48V	
	RATED CURRENT	100A	80A	42A	
	CURRENT RANGE	0 ~ 100A	0 ~ 80A	0 ~ 42A	
	RATED POWER	1200W	1920W	2016W	
	RIPPLE & NOISE (max.) <small>Note.2</small>	150mVp-p	200mVp-p	300mVp-p	
	VOLTAGE ADJ. RANGE	10.5 ~ 14V	21 ~ 28V	42 ~ 56V	
	VOLTAGE TOLERANCE <small>Note.3</small>	±2.0%	±1.0%	±1.0%	
	LINE REGULATION	±1.0%	±0.5%	±0.5%	
	LOAD REGULATION	±1.0%	±0.5%	±0.5%	
	SETUP, RISE TIME	1500ms, 60ms/230VAC at full load			
HOLD UP TIME (Typ.)	16ms/230VAC at 75% load 10ms/230VAC at full load				
INPUT	VOLTAGE RANGE <small>Note.4,5</small>	90 ~ 264VAC 127 ~ 320VDC			
	FREQUENCY RANGE	47 ~ 63Hz			
	POWER FACTOR (Typ.)	0.97/230VAC at full load			
	EFFICIENCY (Typ.)	87%	90.5%	92%	
	AC CURRENT (Typ.) <small>Note.4</small>	13A/115VAC 7A/230VAC	16A/115VAC 10A/230VAC	16A/115VAC 10A/230VAC	
	INRUSH CURRENT (Typ.)	COLD START 50A			
	LEAKAGE CURRENT	<2mA / 240VAC			
PROTECTION	OVERLOAD	105 ~ 125% rated output power Protection type : Constant current limiting, unit will shut down o/p voltage after 5 sec. re-power on to recover			
	OVER VOLTAGE	14.7 ~ 17.5V	29.5 ~ 35V	57.6 ~ 67.2V	
	OVER TEMPERATURE	Shut down o/p voltage, recovers automatically after temperature goes down			
FUNCTION	OUTPUT VOLTAGE PROGRAMMABLE(PV)	Adjustment of output voltage is allowable to 40 ~ 115% of nominal output voltage. Please refer to the Function Manual.			
	CURRENT SHARING	Up to 8000W or (3+1) units. Please refer to the Function Manual.			
	AUXILIARY POWER	5V @ 0.3A, 12V @ 0.8A			
	REMOTE ON-OFF CONTROL	By electrical signal or dry contact Power ON:open Power OFF:short. Please refer to the Function Manual.			
	REMOTE SENSE	Compensate voltage drop on the load wiring up to 0.5V. Please refer to the Function Manual.			
	DC OK SIGNAL	The isolated TTL signal out. Please refer to the Function Manual.			
ENVIRONMENT	WORKING TEMP.	-35 ~ +70°C (Refer to "Derating Curve")			
	WORKING HUMIDITY	20 ~ 90% RH non-condensing			
	STORAGE TEMP., HUMIDITY	-40 ~ +85°C, 10 ~ 95% RH non-condensing			
	TEMP. COEFFICIENT	±0.03%/°C (0 ~ 50°C)			
	VIBRATION	10 ~ 500Hz, 2G 10min./1cycle, 60min. each along X, Y, Z axes			
SAFETY & EMC <small>(Note 6)</small>	SAFETY STANDARDS	UL62368-1, CSA C22.2 No. 62368-1, TUV BS EN/EN62368-1, BSMI CNS14336-1, AS/NZS62368.1, EAC TP TC 004 approved			
	WITHSTAND VOLTAGE	I/P-O/P:3KVAC I/P-FG:2KVAC O/P-FG:0.5KVAC			
	ISOLATION RESISTANCE	I/P-O/P, I/P-FG, O/P-FG:100M Ohms / 500VDC / 25°C / 70% RH			
	EMC EMISSION	Parameter	Standard		Test Level / Note
		Conducted	BS EN/EN55032 (CISPR32)		Class B
		Radiated	BS EN/EN55032 (CISPR32)		Class A
		Harmonic Current	BS EN/EN61000-3-2		-----
		Voltage Flicker	BS EN/EN61000-3-3		-----
	EMC IMMUNITY	BS EN/EN55024, BS EN/EN61000-6-2, BSMI CNS13438			
		Parameter	Standard		Test Level / Note
		ESD	BS EN/EN61000-4-2		Level 3, 8KV air ; Level 2, 4KV contact
		Radiated	BS EN/EN61000-4-3		Level 3
		EFT / Burst	BS EN/EN61000-4-4		Level 3
Surge		BS EN/EN61000-4-5		Level 4, 4KV/Line-Earth ; Level 3, 2KV/Line-Line	
Conducted		BS EN/EN61000-4-6		Level 3	
Magnetic Field		BS EN/EN61000-4-8		Level 4	
Voltage Dips and Interruptions	BS EN/EN61000-4-11		>95% dip 0.5 periods, 30% dip 25 periods, >95% interruptions 250 periods		
OTHERS	MTBF	159K hrs min. Telcordia SR-332 (Bellcore) ; 46.3K hrs min. MIL-HDBK-217F (25°C)			
	DIMENSION	295*127*41mm (L*W*H)			
	PACKING	1.95Kg; 6pcs/12.7Kg/1.15CUFT			
NOTE	<ol style="list-style-type: none"> All parameters NOT specially mentioned are measured at 230VAC input, rated load and 25°C of ambient temperature. Ripple & noise are measured at 20MHz of bandwidth by using a 12" twisted pair-wire terminated with a 0.1uf & 47uf parallel capacitor. Tolerance : includes set up tolerance, line regulation and load regulation. Derating may be needed under low input voltages. Please check the derating curve for more details. Please contact MEANWELL for 320~370VDC application. The power supply is considered a component which will be installed into a final equipment. All the EMC tests are been executed by mounting the unit on a 720mm*360mm metal plate with 1mm of thickness. The final equipment must be re-confirmed that it still meets EMC directives. For guidance on how to perform these EMC tests, please refer to "EMI testing of component power supplies." (as available on http://www.meanwell.com) The ambient temperature derating of 3.5°C/1000m with fanless models and of 5°C/1000m with fan models for operating altitude higher than 2000m(6500ft). <p>※ Product Liability Disclaimer : For detailed information, please refer to https://www.meanwell.com/serviceDisclaimer.aspx</p>				

Block Diagram

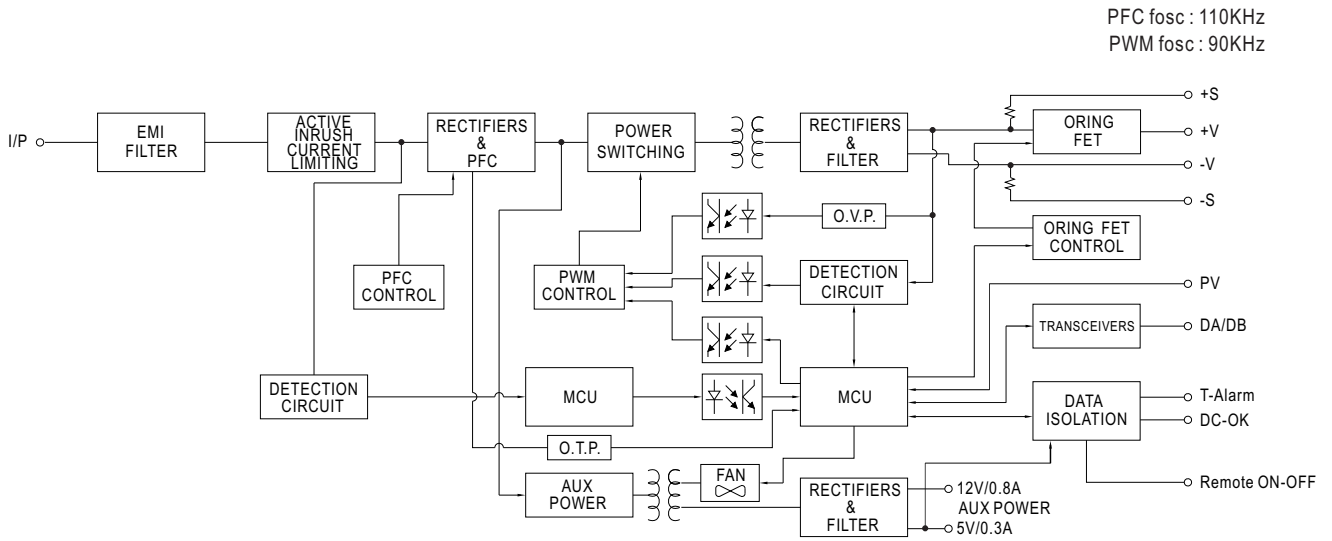

Static Characteristics

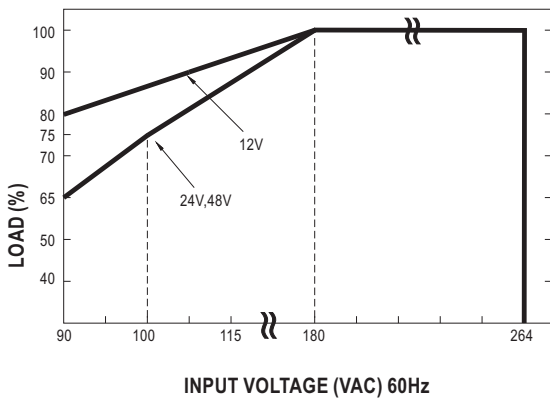

INPUT \ MODEL	12V	24V	48V
180~264VAC	1200W 100A	1920W 80A	2016W 42A
115VAC	1080W 90A	1632W 68A	1713.6W 35.7A
100VAC	1020W 85A	1440W 60A	1512W 31.5A
90VAC	960W 80A	1248W 52A	1310.4W 27.3A

Derating Curve

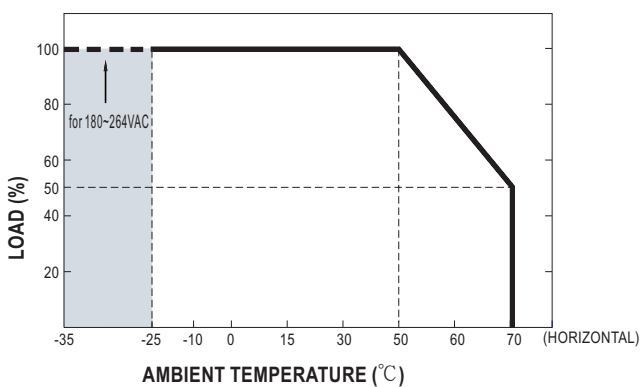

Efficiency vs Load (48V Model)

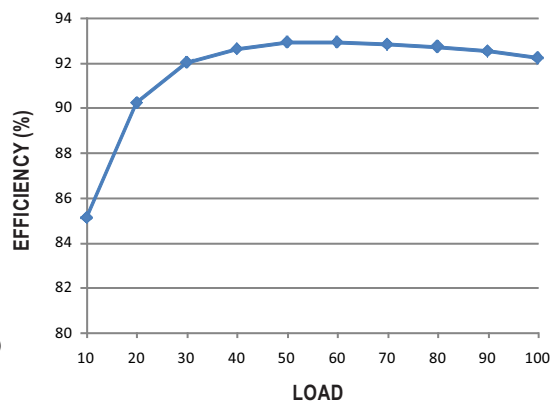

© The curve above is measured at 230VAC.

Function Manual

1. Remote Sense

※ The Remote Sense compensates voltage drop on the load wiring up to 0.5V

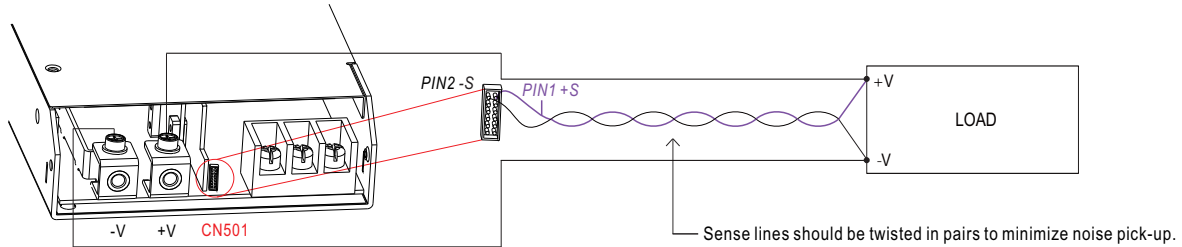

◎ The +S signal should be connected to the positive terminal of the load whereas -S signal to the negative terminal.

2. Output Voltage Programming (or, PV / remote voltage programming / remote adjust / margin programming / dynamic voltage trim)

※ In addition to the adjustment via the built-in potentiometer, the output voltage can be trimmed to 40~115% of the nominal voltage by applying EXTERNAL VOLTAGE.

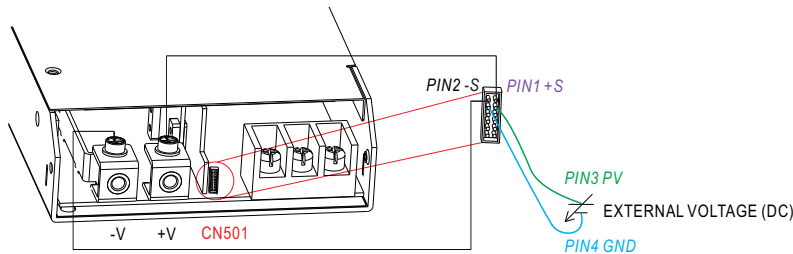

◎ +S & +V, -S & -V also need to be connected on CN501.

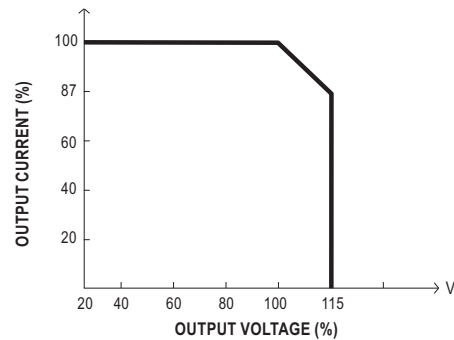
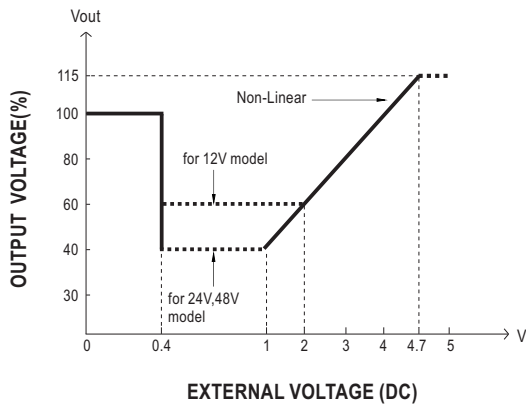

◎ The rated current should change with the Output Voltage Programming accordingly.

3. Remote ON-OFF Control

The power supply can be turned ON/OFF individually or along with other units by using the "Remote ON-OFF" function.

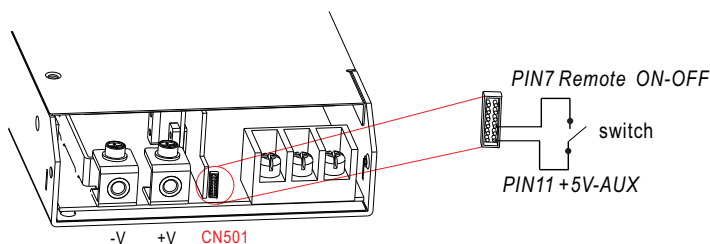

Between Remote ON-OFF and +5V-AUX	Power Supply Status
Switch Open	ON
Switch Short	OFF

4. Current Sharing with Remote Sense

RSP-2000 has the built-in active current sharing function and can be connected in parallel, up to 4 units, to provide higher output power as exhibited below :

- ※ The power supplies should be paralleled using short and large diameter wiring and then connected to the load.
- ※ Difference of output voltages among parallel units should be less than 0.2V.
- ※ The total output current must not exceed the value determined by the following equation:

$$\text{Maximum output current at parallel operation} = (\text{Rated current per unit}) \times (\text{Number of unit}) \times 0.9$$
- ※ Under parallel operation, the minimum output load should be greater than 5% of total output load; otherwise, it is likely that only one unit operates whereas other units may enter standby mode or their LED status indicators may not turn on.
- ※ When the total output current is less than 5% of the total rated current, or say $(5\% \text{ of Rated current per unit}) \times (\text{Number of unit})$ the current shared among units may not be fully balanced.
- ※ CN502/CN504 Function pin connection

Parallel	PSU1		PSU2		PSU3		PSU4	
	CN502	CN504	CN502	CN504	CN502	CN504	CN502	CN504
1 unit	X	V	—	—	—	—	—	—
2 unit	V	V	V	V	—	—	—	—
3 unit	V	V	V	X	V	V	—	—
4 unit	V	V	V	X	V	X	V	V

◎ V is CN502/CN504 connected to plug pin, X is CN502/CN504 not connected to plug pin.

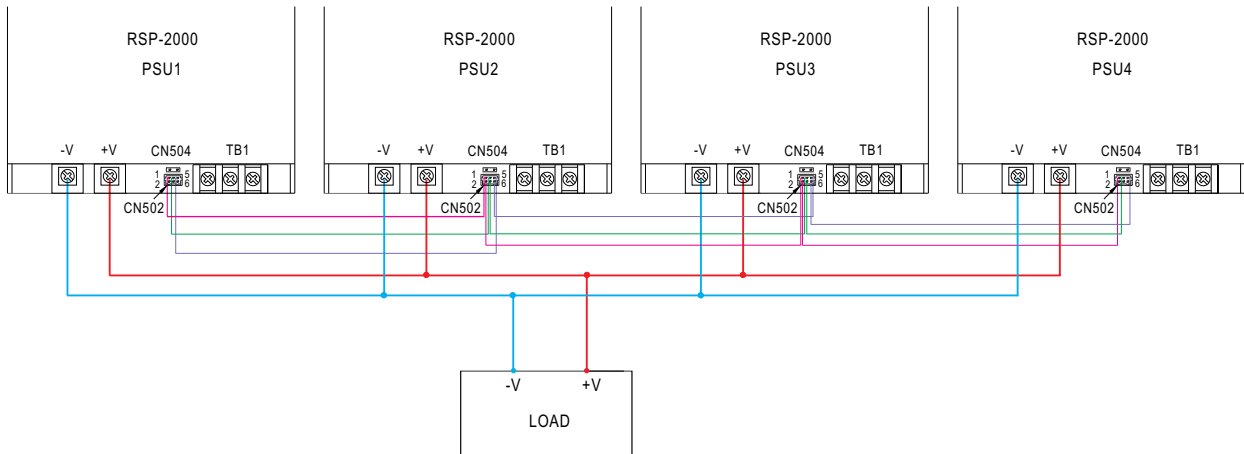
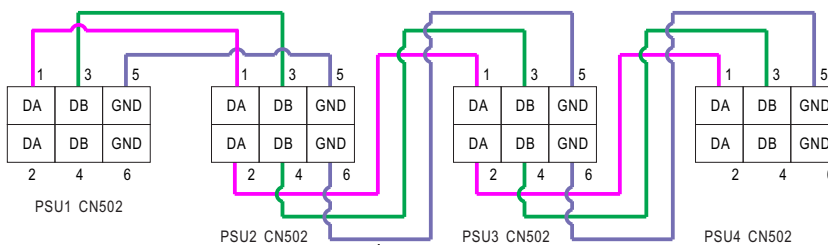

Fig 4.1



If the lines of CN502 are too long, they should be twisted in pairs to avoid the noise.

◎ DA, DB and GND are connected mutually in parallel.

■ Mechanical Specification

Case No. 952D Unit:mm

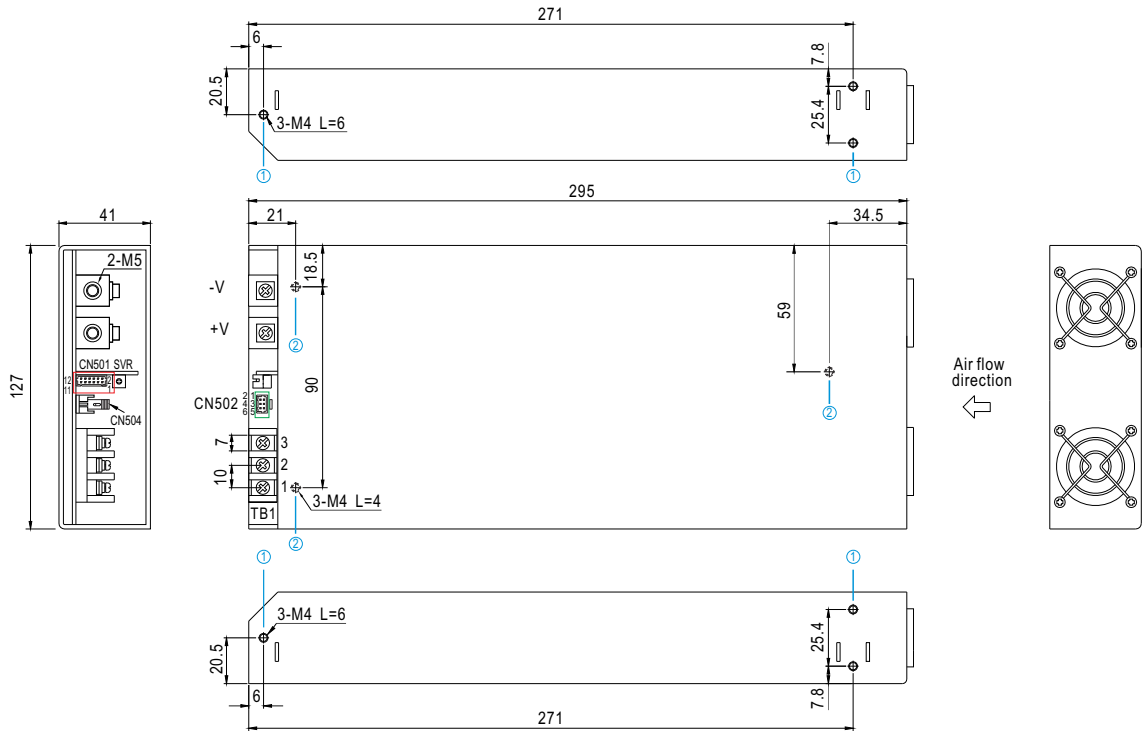

Hole No.	Recommended Screw Size	MAX. Penetration Depth L	Recommended mounting torque
①	M4	6mm	7~10Kgf-cm
②	M4	4mm	7~10Kgf-cm

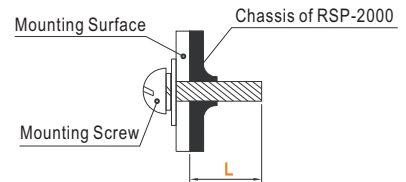

※Control Pin No. Assignment (CN501) : HRS DF11-12DP-2DS or equivalent

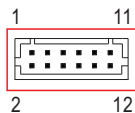

Mating Housing	HRS DF11-12DS or equivalent
Terminal	HRS DF11-12SC or equivalent

Pin No.	Function	Description
1	+S	Positive sensing for remote sense.
2	-S	Negative sensing for remote sense.
3	PV	Connection for output voltage programming. (Note.1)
4	GND	This pin connect to the negative terminal(-V).
5	DC-OK	High (4.5 ~ 5.5V) : When the $V_{out} \leq 80\% \pm 6\%$. Low (0 ~ 0.5V) : When $V_{out} \geq 80\% \pm 6\%$. The maximum sourcing current is 10mA and only for output. (Note.2)
6	T-ALARM	High (4.5 ~ 5.5V) : When the internal temperature (TSW1 or TSW2 open) exceeds the limit of temperature alarm. Low (0 ~ 0.5V) : When the internal temperature (TSW1 or TSW2 short) under the limit temperature. The maximum sourcing current is 10mA and only for output. (Note.2)
7	Remote ON-OFF	The unit can turn the output on and off by electrical signal or dry contact between Remote ON-OFF and +5V-AUX. (Note.2) Short (4.5 ~ 5.5V) : Power OFF ; Open (0 ~ 0.5V) : Power ON ; The maximum input voltage is 5.5V.
8,9,10	GND-AUX	Auxiliary voltage output GND. The signal return is isolated from the output terminals (+V & -V).
11	+5V-AUX	Auxiliary voltage output, 4.5~5.5V, referenced to GND-AUX. The maximum load current is 0.3A. This output has the built-in "Oring diodes" and is not controlled by the Remote ON-OFF control.
12	+12V-AUX	Auxiliary voltage output, 10.6~13.2V, referenced to GND-AUX. The maximum load current is 0.8A. This output has the built-in "Oring diodes" and is not controlled by the Remote ON-OFF control.

Note1: Non-isolated signal, referenced to the output terminals (-V).

Note2: Isolated signal, referenced to GND-AUX.

※LED Indicators & Corresponding Signal at Function Pins

Function	LED	Description	* Signal	Power Supply Output
DC-OK	● GREEN	When output voltage $\geq 80\% \pm 5\%$ of V_o rated.	0 ~ 0.5V	ON
DC-NG	● RED	When output voltage $\leq 80\% \pm 5\%$ of V_o rated.	4.5 ~ 5.5V	ON
T-OK	● GREEN	When the internal temperature (TSW1 & TSW2 short) is within safe limit	0 ~ 0.5V	ON
T-ALARM	● RED	When the internal temperature (TSW1 or TSW2 open) exceeds the limit of temperature alarm	4.5 ~ 5.5V	OFF

*Signal between function pin and "GND-AUX".

※Control Pin No. Assignment (CN502) : HRS DF11-6DP-2DSA or equivalent

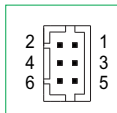

Mating Housing	HRS DF11-6DS or equivalent
Terminal	HRS DF11-6**SC or equivalent

Pin No.	Function	Description
1,2	DA	Differential digital signal for parallel control.
3,4	DB	Differential digital signal for parallel control.
5,6	GND	These pins connect to the negative terminal (-V).

※Control Pin No. Assignment (CN504):

Pin No.	Function	Description
1,2	Terminal resistance	CN504 is the selector of terminal resistor that is designed for DA/DB signals and parallel control function.

※AC Input Terminal Pin No. Assignment

Pin No.	Assignment	Diagram	Maximum mounting torque
1	AC/N		18Kgf-cm
2	AC/L		
3	FG \perp		

※DC Output Terminal Pin No. Assignment

Assignment	Diagram	Maximum mounting torque
+V, -V		10Kgf-cm

■ Installation Manual

Please refer to : <http://www.meanwell.com/manual.html>