

40x40x10 mm

7.0~9.9 CFM



■ Specifications

	Bearing	Rating Voltage	Power Current	Power Consumption	Speed	Air Flow	Static Pressure	Noise	Weight	Curve
	● VAPO	(VDC)	(mA)	(WATTS)	(RPM)	(CFM)	(Inch-H ₂ O)	(dB(A))	(g)	
ME40100V1-000U-A99	●	5	215	1.08	7000	8.0	0.19	32.0	13.5	2
MB40100V2-000U-A99	●	5	180	0.90	5800	7.0	0.11	27.0	17.0	3
ME40101VX-000U-A99	●	12	130	1.60	8500	9.9	0.24	36.1	15.0	1
ME40101V1-000U-A99	●	12	90	1.08	7000	8.0	0.19	32.0	13.5	2
MB40101V2-000U-A99	●	12	80	0.96	5800	7.0	0.11	27.0	17.0	3

Model	Bearing	Rating Voltage	Power Current	Power Consumption	Speed	Air Flow	Static Pressure	Noise	Weight	Curve
	○ 2BALL Sleeve	(VDC)	(mA)	(WATTS)	(RPM)	(CFM)	(Inch-H ₂ O)	(dB(A))	(g)	
EE40100S1-000U-999	○	5	235	1.18	7000	8.0	0.19	32.0	13.5	2
EB40100S2-000U-999	○	5	205	1.00	5800	7.0	0.13	27.0	17.0	3
EE40101S1-000U-999	○	12	100	1.20	7000	8.0	0.19	32.0	13.5	2
EB40101S2-000U-999	○	12	90	1.08	5800	7.0	0.13	27.0	17.0	3

■ Air Flow-Static Pressure Characteristics

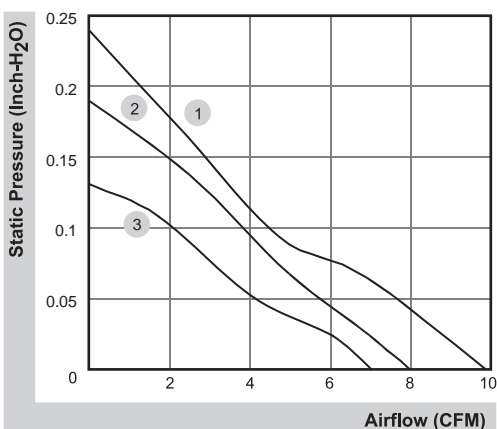

■ External dimensions(mm)

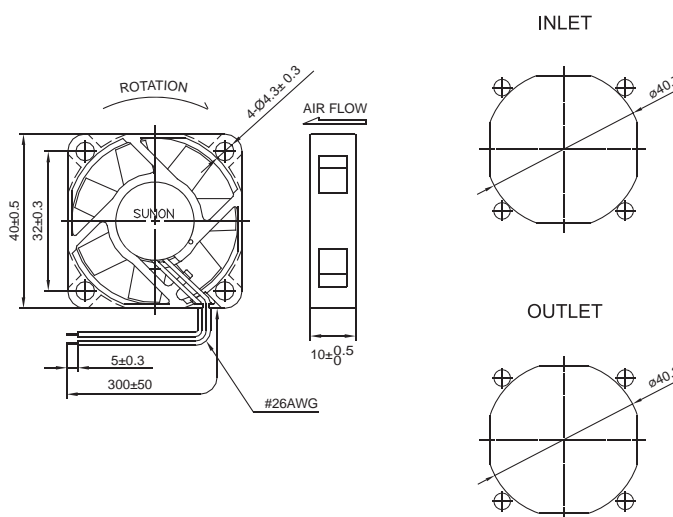

*All model could be customized. Please contact with Sunon Sales.

*Specifications are subject to change without notice. Please Visit SUNON website at <http://www.sunon.com> for update information.