

Date	Rev.	Description

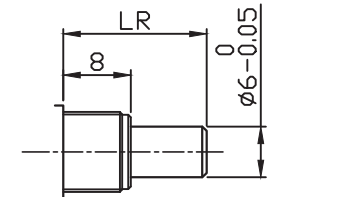
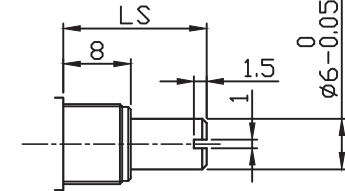
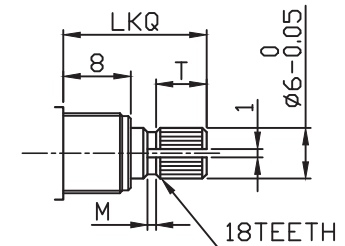
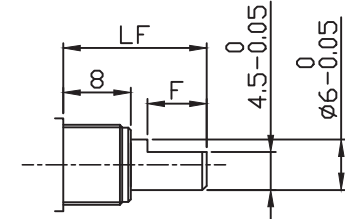
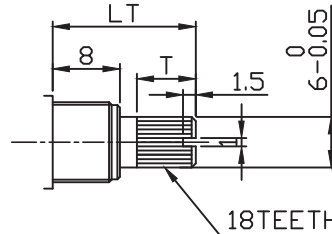
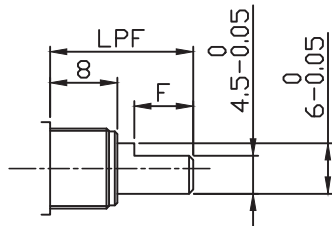
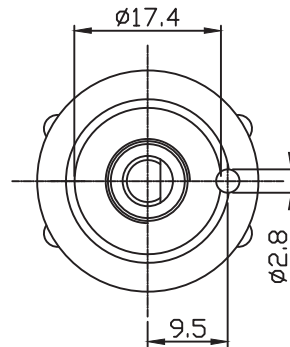
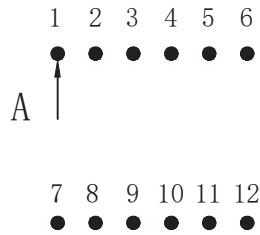
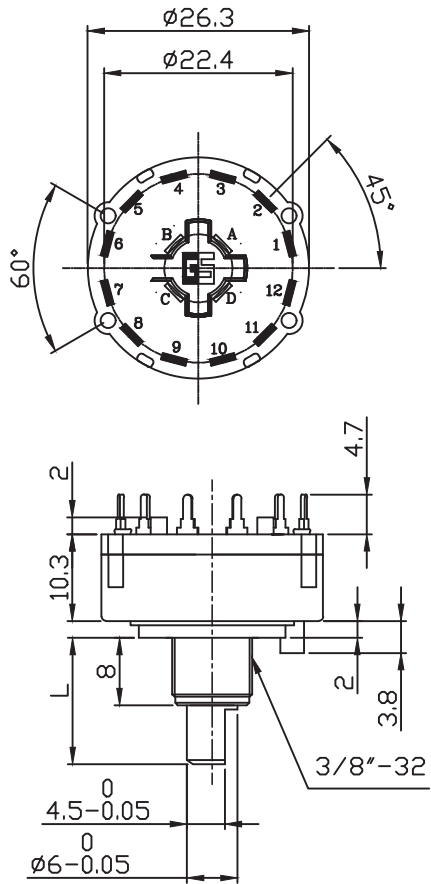

SHAFT SHOWN IN FULL
C. C. W. POSITION

X=T

W	L _T	T
15	15	7
20	20	12

X=PF

W	L _{PF}	F
10	10	8
15	15	7
15(13)	15	13
20	20	12

X=R

W	L _R
10	10
12	12
13	13
15	15
20	20
25	25
30	30
35	35
40	40

X=S

W	L _S
10	10
12	12
13	13
15	15
20	20
25	25
30	30
35	35
40	40

X=KQ

W	L _{KQ}	T	M
10	10	2	0.5
12	12	3	1
13	13	4	1
15	15	5.5	1
20	20	8.5	2
25	25	12	2
30	30	12	2
35	35	12	2
40	40	12	2
28	28	12	2

X=F

W	L _F	F
10	10	2
12	12	3
13	13	4
15	15	7
20	20	12
25	25	12
30	30	12
35	35	12
40	40	12
45	45	15

GOLDSUN ELECTRONICS CO., LTD.

PART NO. **2167322** Rev. **1**

Description :

UNIT mm	SCALE	SHEET 1 OF 1	CAS No: ERN No:
------------	-------	--------------	--------------------

DRAWN : Jay

VERIFY : Arthur / Sam

DCC. NO.
A4 DRAWING NO.