

velleman

DVM 890L

LCD Standard Digital Multimeter

LCD Standaard Digitale Multimeter

Multimètre Digital LCD Standard

USER MANUAL

GEBRUIKERSHANDLEIDING

MANUEL D'UTILISATION

velleman

DVM 890L

LCD Standard Digital Multimeter

1. Introduction

This instrument is a compact, rugged, battery-operated hand-held 3 1/2 digit digital multimeter for measuring DC and AC voltages, DC and AC current and resistance. It also offers the possibility of executing continuity tests and of testing diodes and transistors. You can also measure capacitance and temperatures.

The Dual-Slope A/D Converter uses C-MOS technology for auto-zeroing, polarity selection and overrange indication. Full overload protection is provided. It is an ideal instrument for use in the field, for laboratories and workshops, for hobby and home applications.

1.1 Features

- * Push-button ON/OFF power switch
- * 30 different positions on the user-friendly rotary switch for FUNCTION and RANGE
- * High sensitivity : 100 μ V
- * Automatic overrange indication with the "1" displayed
- * Automatic polarity indication on DC ranges
- * All ranges fully protected
- * Resistance measurements 0.1 Ω to 200M Ω
- * Capacitance measurements 1pF to 20 μ F
- * Diode testing with 1mA fixed current
- * Transistor hFE test with $I_b = -100\mu$ A
- * Temperature measurement with or without K type thermocouple

1.2 A word about safety

This multimeter is designed to ensure the safest operation possible. However, safe operation depends on you, the operator. Make sure you follow these simple safety rules :

- Never apply a voltage to the multimeter that exceeds the specified limits. Never apply more than 1000V DC or 700V rms AC between an input jack and ground.
- Use extreme caution when working with voltages above 60V DC or 30V AC rms.
- Always discharge the filter capacitors in the power supply circuit under test before attaching any test leads.
- Never connect to a voltage source when selecting DCA, ACA, resistance measurement or the continuity check function.
- Always turn off the power and disconnect the test leads before replacing the batteries or fuse.
- Never operate the multimeter unless the battery cover is in place and fully closed.
When carrying out measurements on TVs or switching power circuits, always remember that there may be high amplitude voltage pulses at test points which may damage the meter.

2. Front Panel description

- 1) Display
- 2) Power On/Off button
- 3) Transistor test socket
- 4) RANGE and FUNCTION switch
- 5) Capacity input sockets
- 6) Input connection temperature probe
- 7) mA-input connector
- 8) V/ Ω -input connector
- 9) 20A MAX input connector
- 10) COM-input connector

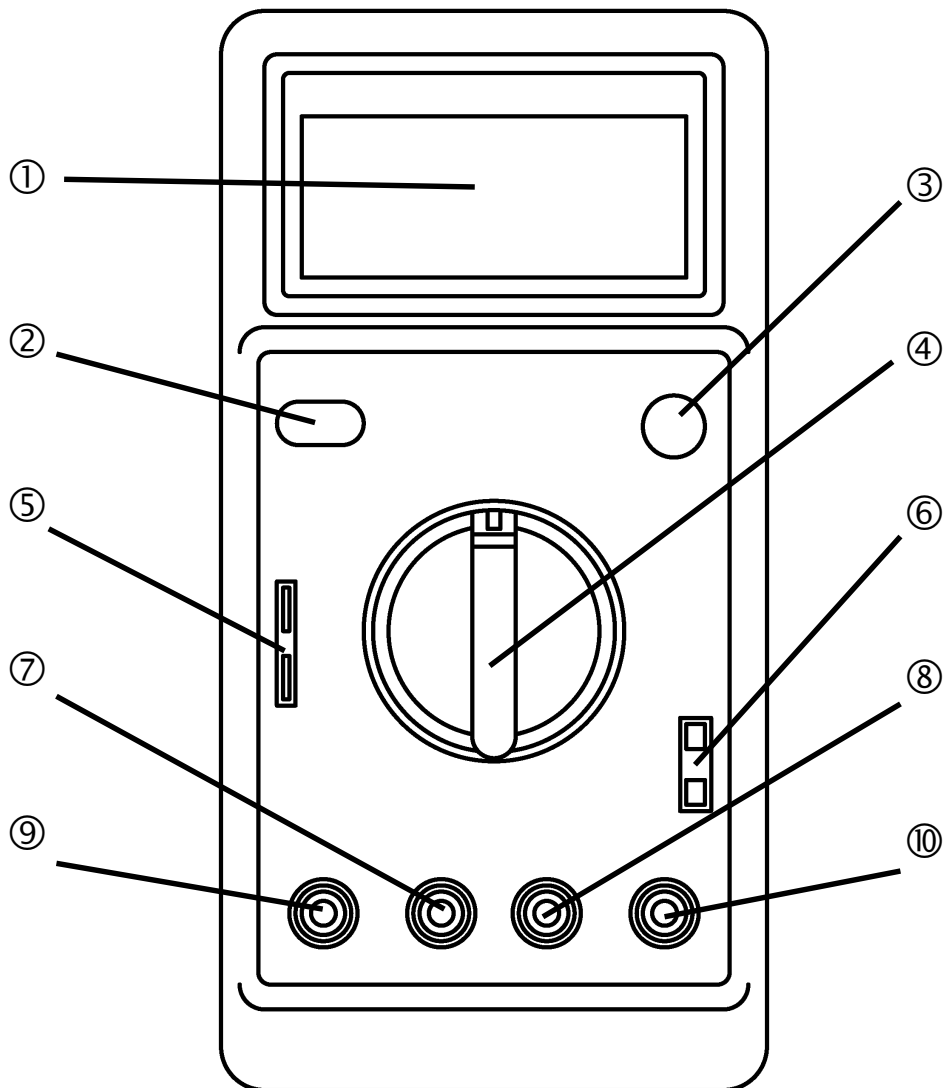

2.1 Function and range selector

Various functions and 32 ranges are provided. A rotary switch is used to select functions as well as ranges.

2.2 Power switch

A push-button is used to turn the meter on or off.

To extend battery life, an Auto Power-Off function is provided. The meter will be turned off automatically within approx. 15 minutes. To turn the meter on again, push the power switch to release the Auto Power-Off function and then push it again.

2.3 Input jacks

This meter has four input jacks that are protected against overload to the limits listed below. During use, connect the black test lead to the COM jack and connect the red test lead in accordance with the selected function.

| FUNCTION | RED LEAD CONNECTION | INPUT LIMITS |
|---|---------------------|---|
| 200mV $\overline{=}$ | V/ Ω | 250V dc or rms ac |
| V $\overline{=}$ & V \sim | V/ Ω | 1000V dc, 700V ac (sine) |
| Hz | V/ Ω | 250V dc or rms ac |
| Ω | V/ Ω | 250V dc or rms ac |
|  | V/ Ω | 250V dc or rms ac |
| mA $\overline{=}$ & mA \sim | mA | 200mA dc or rms ac |
| 20A $\overline{=}$ & 20A \sim | A | 10A dc or rms ac continuous 20A for 15 seconds maximum |

3. Operating instructions

- 1) Check the 9V battery by setting the ON-OFF switch to the ON position. If the battery is weak, a "⚡" sign will appear on the display.
If this sign does not appear on the display, proceed as mentioned below. Read MAINTENANCE if the battery has to be replaced.
- 2) The ⚠ sign next to the test lead jacks warns you of the fact that the input voltage or current should not exceed the indicated values.
This serves to prevent the internal circuitry from damage.
- 3) The function switch should be set to the desired range before use.

3.1 DC Voltage measurement

- 1) Connect the black lead (-) to the COM input connector and the red lead (+) to the V/Ω input connector.
- 2) Set the FUNCTION switch to the V $\overline{=}$ range to be used and connect the test leads to the source or load being tested.
- 3) The polarity of the RED lead connection will be indicated on the LCD display.

Note :

- 1) If the voltage range is unknown beforehand, set the FUNCTION switch to a high range and work your way down.
- 2) The figure "1" on your display indicates overrange. This means that the FUNCTION switch should be set to a higher range.
- 3) ⚠ Do not apply more than 1000V to the input. Higher voltages can be applied BUT may very well damage the internal circuitry.
- 4) Use extreme caution to avoid contact with high tension circuits when measuring sources of high voltage.

3.2 AC Voltage measurement

- 1) Connect the black lead (-) to the COM input connector and the red lead (+) to the V/Ω/f input connector.
- 2) Set the FUNCTION switch to the appropriate V \sim range and connect the test leads to the source or load being tested.
- 3) Read the LCD display.

Note :

- 1) See DC voltage measurement.
- 2) ⚠ Do not apply more than 700V rms to the input. . Higher voltages can be applied BUT may very well damage the internal circuitry.
- 4) Use extreme caution to avoid contact with high tension circuits when measuring sources of high voltage.

3.3 DC Current measurement

- 1) Connect the black test lead (-) to the COM input connector and the red test lead (+) to the mA input connector or a maximum of 200mA. Move the red test lead to the 20A MAX input connector for a maximum of 20A.
- 2) Set the FUNCTION switch to the A $\overline{=}$ range.
- 3) Connect the test leads **IN SERIES** to the load under measurement.
- 4) Read LCD display. The polarity at the RED test lead connection will be indicated.

Note :

- 1) If the current range is unknown beforehand, set the FUNCTION switch to a high range and work your way down.
- 2) The figure "1" on your display indicates overrange. This means the FUNCTION switch should be set to a higher range.
- 3)  The maximum input current is 200mA or 20A depending on the jack. Excessive current will blow the fuse. The 20A range is not protected by a fuse. The fuse rating should not exceed 200mA in order to prevent damage to the internal circuitry.
- 4) The maximum terminal voltage drop is 200mV.

3.4 AC Current measurement

- 1) Connect the black test lead (-) to the COM input connector and the red test lead (+) to the 200mA input connector for a maximum of 200mA.. Move the red test lead to the 20A input connector for a maximum of 20A.
- 2) Set the FUNCTION switch to the A \sim range.
- 3) Connect the test leads **IN SERIES** to the load being tested.
- 4) Read the LCD display.

Note :

- 1) If the current range is unknown beforehand, set the FUNCTION switch to a high range and work your way down.
- 2) The figure "1" on your display indicates overrange. This means that the FUNCTION switch should be set to a higher range.
- 3)  The maximum input current is 200mA or 20A depending on the jack. Excessive current will blow the fuse. The 20A range is not protected by a fuse. The fuse rating not exceed 200mA in order to prevent damage to the internal circuitry.
- 4) The maximum terminal voltage drop is 200mV.

3.5 Resistance measurement

- 1) Connect the black lead (-) to the COM input connector and the red lead (+) to the V/ Ω /f input connector.
- 2) Set the FUNCTION switch to the appropriate Ω range and connect the test leads to the resistance being tested.

Note :

- 1) The overrange indication ("1") will be displayed if the resistance value being measured exceeds the maximum value of the selected range. Consequently, you should select a higher range. It may take the meter a few seconds to become stable when measuring a resistance of approximately 1 M Ω and more. This is normal for high resistance readings.
- 2) When the input is not connected, i.e. when the circuit is open, the figure " 1 " will be displayed for the overrange condition.
- 3) When checking in-circuit resistance, verify whether the circuit being tested is not connected and whether all capacitors are fully discharged.
- 4) The open circuit voltage for the 200M Ω range is 3V. Upon shorting the test leads, the display will show 10 digits. This is normal when encountering a 10M Ω resistance value (for the 200M Ω range). When measuring 100M Ω (for the 200M range), the display reading will be 110. The 10 digits are a constant and should be subtracted from the readings.
- 5) Some devices may be damaged by the current applied during resistance measurements. The following table lists the voltage and current available for each range.

A: open circuit voltage at the jack

B: voltage for a resistance equal to full scale value.

C: current in milliampères through a short circuit at the input jacks. All values are typical.

| RANGE | A | B | C |
|--------------|------|------|---------------|
| 200 Ω | 0.65 | 0.08 | 0.44 |
| 2K | 0.65 | 0.3 | 0.27 |
| 20K | 0.65 | 0.42 | 0.06 |
| 200K | 0.65 | 0.43 | 0.007 |
| 2M | 0.65 | 0.43 | 0.001 |
| 20M | 0.65 | 0.43 | 0.0001 |
| 200M | 3 | 2.98 | 0.3-3 μ A |

3.6 Capacitance measurements

- 1) Before connecting the test capacitor, note that the display may show readings other than zero each time the range is changed. This reading will not affect the accuracy of the device for it will be overridden by the actual value upon measurement.
- 2) Connect the test capacitor to the input sockets (not test leads). Check the polarity connections wherever necessary and set the FUNCTION switch to the CX range.

Note :

- 1) When testing individual capacitors, insert the leads of the capacitor into the "+" socket (upper socket) and "-" socket (lower socket), to the left of the panel. (Capacitors should be discharged before being inserted into the test jack).
- 2) When testing polarised capacitors (e.g. a tantalum type), particular attention must be paid to the polarity connections in order to prevent possible damage to the capacitor.

When testing large capacitors, note that there will be a certain time lag before the final reading is displayed.

Units : 1pF = 10⁻⁶ μ F 1nF = 10⁻³ μ F.

 Do not connect an external voltage or a charged capacitor (especially larger capacitors) to the measuring terminals.

3.7 Diode measurement and Continuity test

- 1) Connect the black lead (-) to the COM input connector and the red lead (+) to the V/ Ω /f input connector.
- 2) Set the FUNCTION switch to the  range and connect the test leads to the diode under measurement. The display will show the approx. forward voltage of this diode.
- 3) For continuity tests : connect the test leads to two random points of the circuit. A buzzer will sound if the resistance is lower than approx. 30 Ω .

3.8 Transistor hFE test

- 1) Set the FUNCTION switch to the hFE range.
- 2) Determine whether the transistor is NPN or PNP and locate the emitter, base and collector leads. Insert the leads into the proper holes in the socket on the front panel.
- 3) The display will show the approximate hFE-value at the moment of testing. Base current 10 μ A, V_{ce} 2.8V.

3.9 Temperature measurement

- 1) Measure temperature with a K-type thermocouple : Set the FUNCTION switch to the T-range and insert the K-type thermocouple plug into the K-PROBE socket.
- 2) Measure ambient temperature without a probe : Use the same T-range, the display will show the ambient temperature in $^{\circ}$ C.

Note :

- 1) When measuring temperature with a thermocouple, never touch the cold end (the near end plug) of the thermocouple with your bare hands as your body temperature will affect the accuracy of the measurement.

3.10 Auto Power-off

Automatic Power-off extends the battery-life by turning the meter off whenever it has been unused for the last 15 min. The meter turns back on if either the rotary switch is turned or the power switch is pressed.

4. Specifications

Maximum accuracy is achieved during a one-year period after calibration. Ideal circumstances require a temperature of 23°C ($\pm 5^\circ\text{C}$) and a relative humidity under 75%.

4.1 General

| | |
|-------------------------------------|---|
| Maximum display | 1999 counts (3 1/2 digits) with automatic polarity indication and eng. unit. |
| Indication method | LCD display |
| Measuring method | Dual-slope integration A-D converter system |
| Overrange indication | Only "1" is displayed |
| Maximum common mode voltage | 500V dc/ac rms |
| Reading rate | 2-3 readings per sec. (approx.) |
| Temperature for guaranteed accuracy | 23°C $\pm 5^\circ\text{C}$ |
| Temperature range | Operating : 0°C to 40°C, 32°F to 104°F Storage : -10°C to 50°C, 14°F to 122°F |
| Power supply | 1 x 9V battery |
| Battery-low indication | Battery sign to left of display |
| Size | 88 x 170 x 38mm |
| Weight | 340g (including 9V battery) |
| Accessories | Operating manual. Set of test leads Thermocouple (K type, 400°C) Spare fuse (200mA/250V fast blow) (OPTION) 9V battery Soft carrying case (OPTION) |

4.2 DC Voltage

| Range | Resolution | Accuracy |
|-------|-------------------|-----------------------------------|
| 200mV | 100 μV | $\pm 0.5\%$ of rdg ± 1 digits |
| 2V | 1mV | |
| 20V | 10mV | |
| 200V | 100mV | |
| 1000V | 1V | $\pm 0.8\%$ of rdg ± 2 digits |

Input impedance : 10M Ω for all ranges

Overload protection : 1000V DC or peak AC for all ranges

4.3 AC Voltage

| Range | Resolution | Accuracy |
|-------|-------------|-----------------------------------|
| 200mV | 100 μ V | $\pm 1.2\%$ of rdg ± 3 digits |
| 2V | 1mV | $\pm 0.8\%$ of rdg ± 3 digits |
| 20V | 10mV | |
| 200V | 100mV | |
| 700V | 1V | $\pm 1.2\%$ of rdg ± 3 digits |

Input impedance : 10M Ω for all ranges

Frequency range : 40 to 400Hz

Overload protection : 750Vrms or 1000V peak continuous for the ac ranges, with the exception of the 200mV AC range (max.15 seconds above 300Vrms)

4.4 DC Current

| Range | Resolution | Accuracy |
|-------|-------------|-----------------------------------|
| 2mA | 1 μ A | $\pm 0.8\%$ of rdg ± 1 digits |
| 20mA | 10 μ A | |
| 200mA | 100 μ A | $\pm 1.2\%$ of rdg ± 1 digits |
| 20A | 10mA | $\pm 2\%$ of rdg ± 5 digits |

Overload protection : F 0.2A fuse (20A range not fuse-protected)

Maximum input current : 20A, 15 sec.

4.5 AC Current

| Range | Resolution | Accuracy |
|-------|-------------|-----------------------------------|
| 20mA | 10 μ A | $\pm 1.2\%$ of rdg ± 3 digits |
| 200mA | 100 μ A | $\pm 2.0\%$ of rdg ± 3 digits |
| 20A | 10mA | $\pm 3\%$ of rdg ± 7 digits |

Overload protection : F 0.2A fuse (20A range not fuse-protected)

Frequency range : 40 to 400Hz

Maximum input current : 20A 15sec.

Response : average (rms of sine wave)

4.6 Resistance

| Range | Resolution | Accuracy |
|-------|------------|--------------------------|
| 200Ω | 0.1Ω | ± 0.8% of rdg ± 3 digits |
| 2kΩ | 1Ω | ± 0.8% of rdg ± 1 digits |
| 20kΩ | 10Ω | |
| 200kΩ | 100Ω | |
| 2MΩ | 1kΩ | |
| 20MΩ | 10kΩ | ± 1% of rdg ± 2 digits |
| 200MΩ | 100kΩ | ± 5% of rdg ± 10 digits |

For the 200MΩ range, short the two test leads first. If the displayed value comprises 10 digits, these 10 digits should be subtracted from the measurement result.

4.7 Capacitance

| Range | Resolution | Accuracy |
|--------|------------|--------------------------|
| 2000pF | 1pF | ± 2.5% of rdg ± 5 digits |
| 20nF | 10pF | |
| 200nF | 100pF | |
| 2μF | 1nF | |
| 20μF | 10nF | |



4.8 Transistor hFE test

| Range | Description | Test condition |
|-------|---|---|
| hFE | Display shows approx. hFE-value (0-1000) of the transistor under test (ALL TYPES) | Base Current approx. 10μA, Vce approx. 2.8V |

4.9 Temperature

| Range | Temperature range | Accuracy | Resolution |
|-----------------------------------|-------------------|----------------------|------------|
| T | ★ - 50°C - 400°C | ± 0.75% of rdg ± 3°C | 1°C |
| | ★ 400°C - 1000°C | ± 1.5% of rdg ± 15°C | 1°C |
| | ★ ★ 0°C - 40°C | ± 2°C | 1°C |
| ★ Using K type thermocouple probe | | | |
| ★ ★ Built-in temperature sensor | | | |

4.10 Diode Test and Audible Continuity Test

| Range | Description | Test Condition |
|---|--|---|
|  | Display shows approx. forward voltage of diode | Forward DC current approx. 1mA Reversed DC voltage approx. 2.8 Volts |
|  | Built-in buzzer sounds if conductance is less than approx. 30Ω | Open circuit voltage approx. 2.8 Volts |

5. Maintenance

Your Digital Multimeter is an electronic precision instrument. In order to avoid damage, avoid tampering with the circuitry.

A: Never connect more than 1000 Volts DC or 700 Volts AC to the instrument.

B: Never connect a voltage source to the instrument with its function switch set to the OHM position.

C: Never operate the DVM unless the back cover is in place and fully closed.

D: Battery and/or fuse replacement should only be performed once the test leads have been disconnected and the power is OFF.

5.1 9-Volt battery replacement

Check the condition of the 9V battery when following the procedure described above. If the battery needs to be replaced : open the back cover, remove the old battery and replace it with a battery of the same type.

5.2 Fuse replacement

Should the fuse need replacement : only use 200mA fuses that are identical to the original in physical size.