

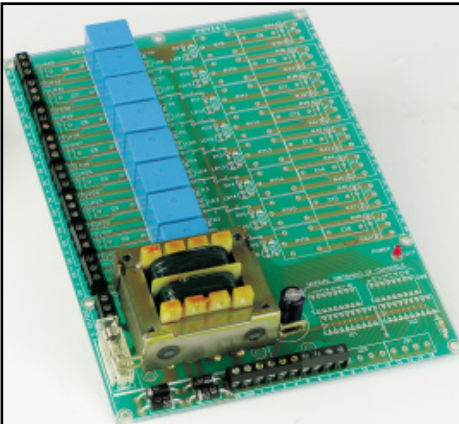

Universal Relay Card

K6714 & K6714 - 16

- ☑ *The relays can be controlled in different ways : direct control from open-collector outputs, TTL or CMOS level or trough other kits (K6711, K8000, K8023,...)*
- ☑ *DIP switches are included to allow manual activation of the relays in case of maintenance work.*
- ☑ *Every output of the print can be equipped with a noise suppressor network.*
- ☑ *Output 12V CC can be used as a power supply for other kits: K6711, K8023,...*



K6714



8 output relays

Specifications :

- *Power supply: 230 or 125VAC max. 12VA.*
- *Output voltage: 12V/250mA.*
- *Relay switch-over contact : max. 5A at 220V.*
- *Dimensions : 150 x 212mm*

K6714-16



16 output relays

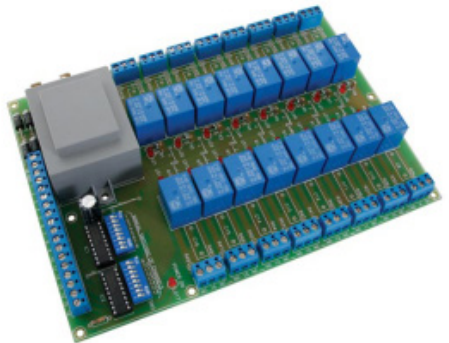

VELLEMAN NV
Legen Heirweg 33
9890 Gavere
Belgium Europe
www.velleman.be

1. Assembly (Skipping this can lead to troubles !)

Ok, so we have your attention. These hints will help you to make this project successful. Read them carefully.

1.1 Make sure you have the right tools:

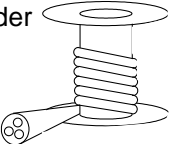
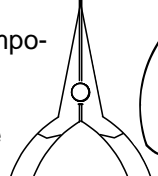
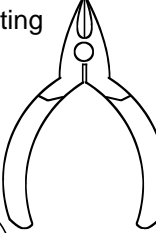
- A good quality soldering iron (25-40W) with a small tip. 
- Wipe it often on a wet sponge or cloth, to keep it clean; then apply solder to the tip, to give it a wet look. This is called 'thinning' and will protect the tip, and enables you to make good connections. When solder rolls off the tip, it needs cleaning. 
- Thin raisin-core solder. Do not use any flux or grease.
- A diagonal cutter to trim excess wires. To avoid injury when cutting excess leads, hold the lead so they cannot fly towards the eyes.
- Needle nose pliers, for bending leads, or to hold components in place. 
- Small blade and phillips screwdrivers. A basic range is fine. 



For some projects, a basic multi-meter is required, or might be handy

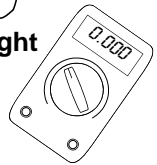

1.2 Assembly Hints :

- ⇒ Make sure the skill level matches your experience, to avoid disappointments.
- ⇒ Follow the instructions carefully. Read and understand the entire step before you perform each operation.
- ⇒ Perform the assembly in the correct order as stated in this manual
- ⇒ Position all parts on the PCB (Printed Circuit Board) as shown on the drawings.
- ⇒ Values on the circuit diagram are subject to changes.
- ⇒ Values in this assembly guide are correct*
- ⇒ Use the check-boxes to mark your progress.
- ⇒ Please read the included information on safety and customer service

* Typographical inaccuracies excluded. Always look for possible last minute manual updates, indicated as 'NOTE' on a separate leaflet.

1.3 Soldering Hints :

1- Mount the component against the PCB surface and carefully solder the leads

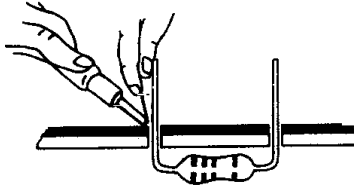

2- Make sure the solder joints are coneshaped and shiny

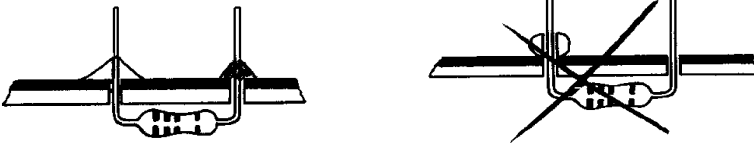

3- Trim excess leads as close as possible to the solder joint

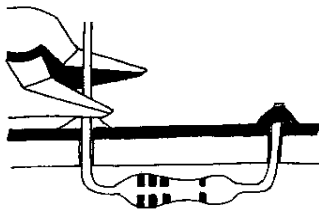

AXIAL COMPONENTS ARE TAPED IN THE CORRECT MOUNTING SEQUENCE !

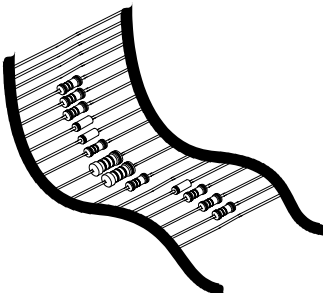

REMOVE THEM FROM THE TAPE ONE AT A TIME !

COLOR=2...5

1%

5%

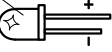
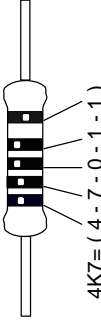
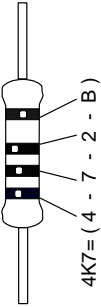

	I	P	E	SF	S	DK	N	D	GB	F	NL
C	CODICE	CODIGO	CODIGO	VÁRI	FÁRG	FARVEK	FARGEK	FARB	COLOUR	CODIFI-	KLEURC
O	COLORE	DE	DE	KOODI	SCHEMA	ODE	ODE	KODE	CODE	CATION	KODE
D										DES	D
E										COU-	E
										LEURS	
0	Nero	Preto	Negro	Musta	Svart	Sort	Sort	Schwarz	Black	Noir	Zwart
1	Marrone	Castanho	Marrón	Ruskea	Brun	Brun	Brun	Braun	Brown	Brun	Bruin
2	Rosso	Encarnad	Rojo	Punainen	Röd	Röd	Röd	Rot	Red	Rouge	Rood
3	Aranciat	Laranja	Naranjad	Oranssi	Orange	Orange	Orange	Orange	Orange	Orange	Oranje
4	Giallo	Amarelo	Amarillo	Keltainen	Gul	Gul	Gul	Gelb	Yellow	Jaune	Geel
5	Verde	Verde	Verde	Vihreä	Grön	Grøn	Grønn	Grün	Green	Vert	Groen
6	Blu	Azul	Azul	Sininen	Blå	Blå	Blå	Blau	Blue	Bleu	Blauw
7	Viola	Violeta	Morado	Purppura	Lila	Violet	Violet	Violet	Purple	Violet	Paars
8	Grigio	Cinzento	Gris	Harmaa	Grå	Grå	Grå	Grau	Grey	Gris	Grijs
9	Bianco	Branco	Blanco	Valkoinen	Vit	Hvid	Hvidt	Weiss	White	Blanc	Wit
A	Argento	Prateado	Plata	Hopea	Silver	Sølv	Sølv	Silber	Silver	Argent	Zilver
B	Oro	Dourado	Oro	Kulta	Guld	Guld	Guldi	Gold	Gold	Or	Goud

IMPORTANT

 To use the relay card with 16 relay outputs, mount the components marked with (*) also (K6714-16).

TIP : The pictures on the packaging can be used as a guideline. However, due to possible changes it is not 100% reliable.

Mount the components in the order described :

1. Jumperwires

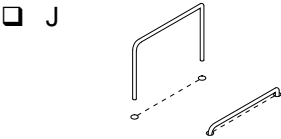

ATTENTION : In case you don't use a transistor array (IC's for K6714-16), fit the wire jumpers in the places for IC1 and IC2, marked with a dotted line.

4. LED's (Watch the polarity!)

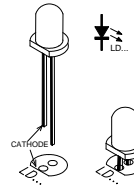

- LD1...LD16 : 3mm LED. (*)
- LD17 : 3mm LED.

2. Diodes (Watch the polarity!)

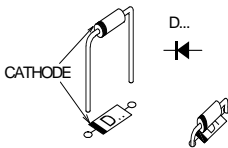

- D1.....D8 : 1N4148.
- D9.....D16 : 1N4148 (*)
- D17....D20 : 1N5408.

5. IC socket (Watch the position of the notch!)

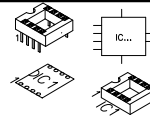

- IC1 ... IC2 : 18P. (*)

Attention : just for K6714-16 !

3. 1/4W Resistors (Watch the color code!)

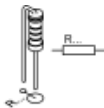

- R1.....R16 : 1K5 (1-5-2-B) (*)

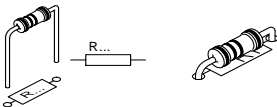

- R17 : 1K5 (1-5-2-B).

6. Dip Switch (watch the orientation!)

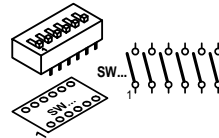

- SW1 : Dip-8 (*)
- SW2 : Dip-8 (*)

7. Fuseholder and fuse

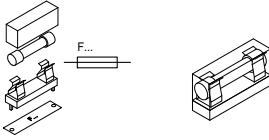

- F1 : 0,25A slow.

8. Terminal blocks

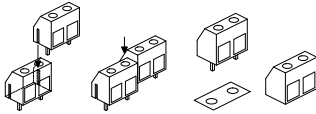

Tree-pole screw connector :

- J1...J8
- J9...J16 (*)
- J17

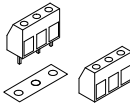

Six-pole screw connector :

- J18

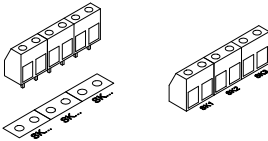

6p = 3x2p

Four-pole screw connector :

- J19
- J20, J21 (*)

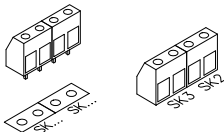

4p = 2x2p

9. Relay

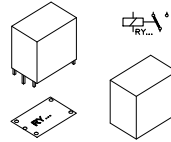

- RY1...RY8 : VR15M121C
- RY9...RY16 : VR15M121C (*)

10. Electrolytic capacitors (Watch the polarity !)

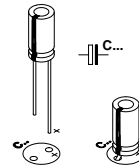

- C17 : 1000 µF/25V

11. Transformer

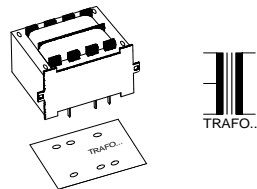

- Trafo : 206012 (12VA 2x6V—1A)

Attention : See that the 6 or 220V connections come in the right place.

12. IC's (Watch the polarity !)

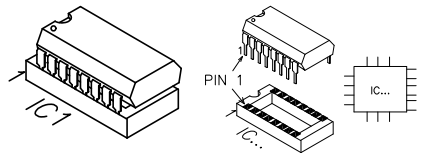

- IC1, IC2 : ULN2803 (*)

Noise suppression of the relay contacts “OPTIONAL !” :

At the standard module K6714 as well K6714-16 have you the opportunity to noise-suppress every relay contact.

First : mount the resistors to noise-suppress the normally open contact of the relay :

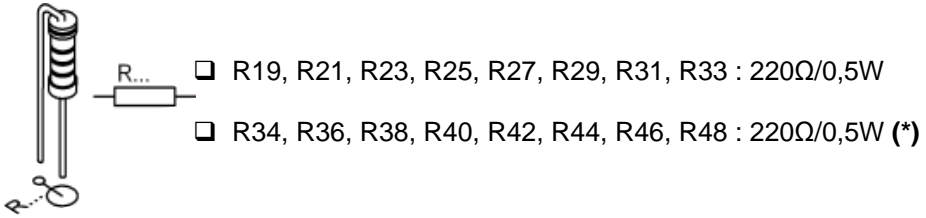

Or mount the resistors to noise-suppress the normally closed contact of the relay :

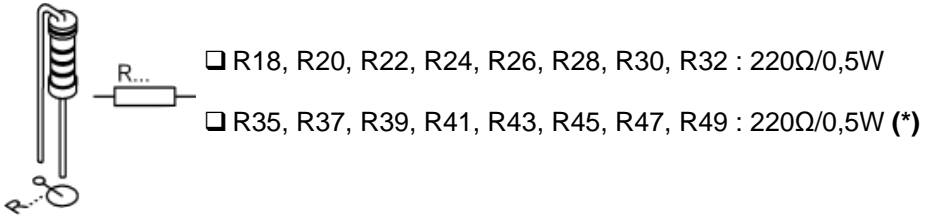

Next mount the capacitors :

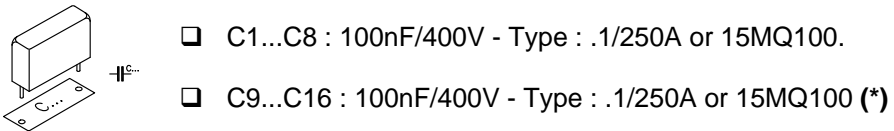

To use the relay card with 16 relay outputs, mount the components marked with (*) also (K6714-16).

IMPORTANT :

If you want an electronic controller to be able to switch higher currents and at the same time you need an insulation between the controller and the controlled items, then a relay module is an indispensable help.

The module is very well suited to be connected to our kits K6711 (15 channel IR receiver) and one or two times K8023.

For those two kits power can be taken direct from the relay module. The module can also be used together with the open collector interface module K2609 and K8000.

The module can of course also be used very well in other applications.

OPTIONS :

In its standard version the module contains 8 relays (K6714), but in the full version the module (K6714-16) contains :

- ✔ 16 relays.
- ✔ DIP switches for manual operation.
- ✔ A noise suppressor network for each output.
- ✔ An indication LED per relay.
- ✔ A ULN2803 type transistor array (IC's).

You can fit the standard module K6714 with another 8 relays (12V types) yourself. However this requires the installation of additional screw connectors.



The ULN2803 type transistor array allows you to control the relays direct from a TTL or CMOS. For controlling the relay with open collector control, don't mount the transistors arrays.

TEST AND CONNECTIONS :

Connect the phase to “0” and the Neutral to “125” or “220”, depending on the mains voltage.

Normally the POWER ON LED should be lit now.
 In case no manual operation has been provided, you can test the relay by connecting the inputs (terminals 1 trough 16) to earth (GND) one after another.

Connections possibility's :

1. Connect the board to the 15 channel receiver K6711 (see Fig. 1.0)

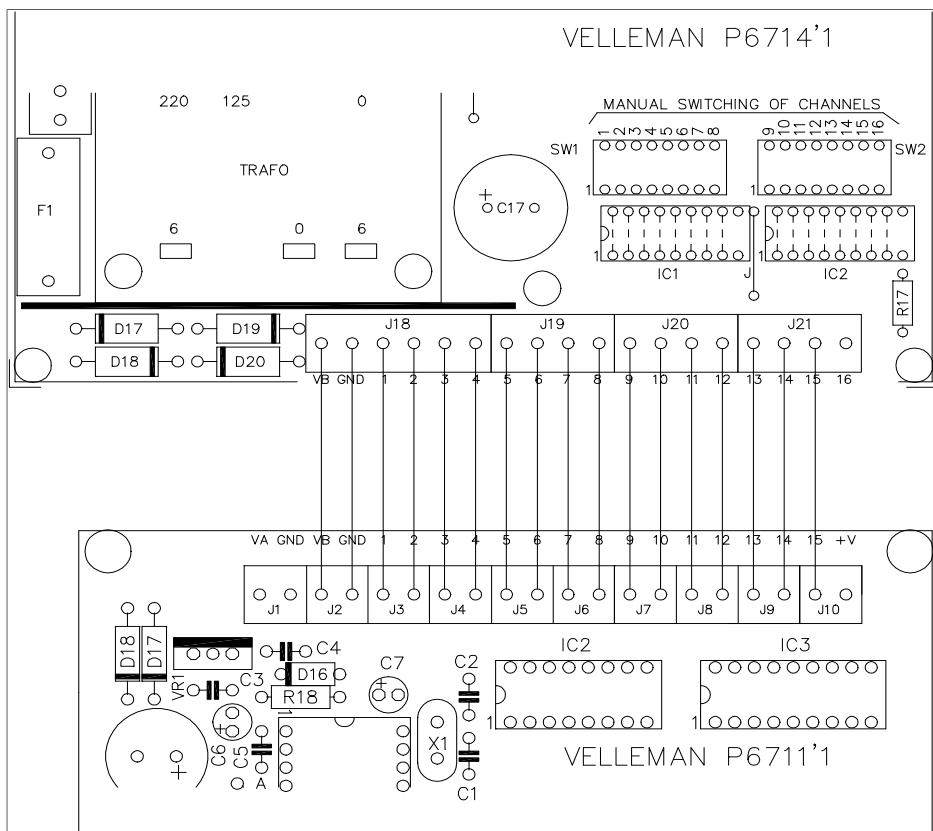

FIG 1.0

2. Connect the board to the 10 channel, 2 wire remote control K8023 (see Fig. 2.0) :

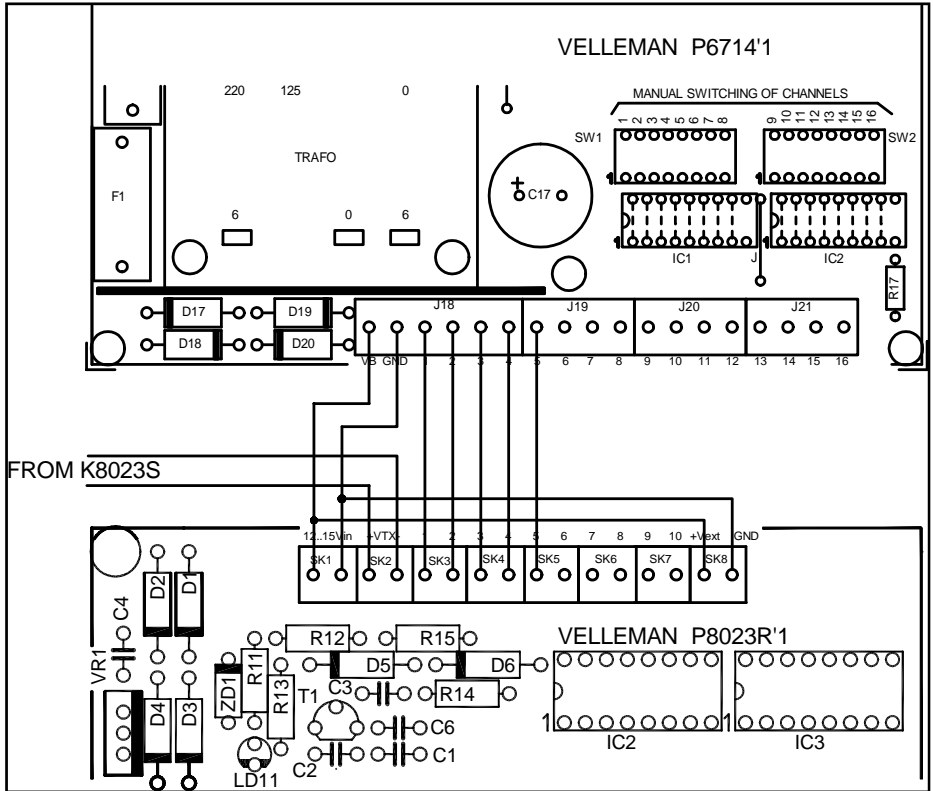

FIG 2.0

Remedies in the case of malfunction cused by the relays

If the relays are used to switch alternating voltage, it may be necessary to suppress them.

1. Suppressing resistive loads (Lamp, resistor,...) :

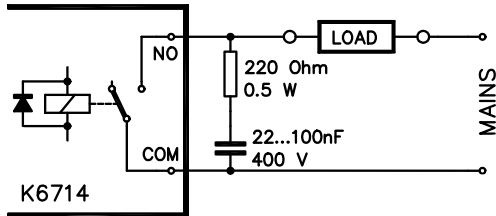

FIG. 3.1

2. Suppressing inductive loads (Transformer, motor,...) :

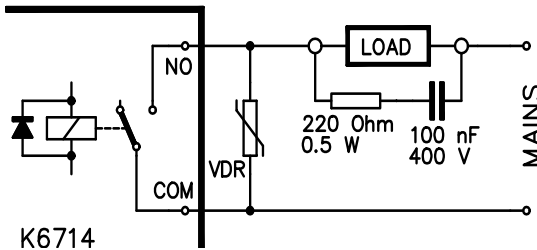

FIG 3.2

3. When above solutions fail :

In this last case an independently feeded DC-relay is used, wich is installed as close to the load as possible.



Pay attention to the diode witch is fit ANTI-parallel with the coil, its cathode connected to the plus side, its anode connected to the minus side! This relay **MUST** be feeded by a separate power supply. The VDR must be suited for the voltage to be switched.

FIG 3.3

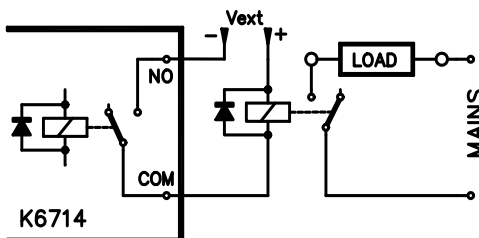

220V - 240V

Siemens SIOV
S14K275

110V - 125V

Siemens SIOV
S14K150

INFORMATION FOR UPGRADING YOUR MODULE !

Components necessary to upgrade the K6714 to K6714-16 “16 Relay outputs” :

Component	Quantity	Description	Order Nr.
Diodes	8	1N41418 small signal diode.	1N4148
Resistors	16	1/4W—1K5	
LED's	16	3mm Rd 1.0 MCD TD universal	LED3RLN
IC Socket	2	18P DIL IC Socket 300 Mil.	18P
DIP switch	2	DS-8 DIP switch 1P and 8Pos.	DS-8
Terminal blocks	6	Screw connector print 2 pole Blue	Screw02
Terminal blocks	8	Screw connector print 3 pole Blue	Screw03
Relays	8	Miniature Rel 12V/15A/1C JZC-22F 1Z	Vr15M121 C
IC's	2	Octal high Current/High Voltage Driver	ULN2803

OPTION : Noise suppression of the relay contacts :

Component	Quantity	Description	Order Nr.
Resistors	8*	0,5W / 220 Ohm	FB220E0
Capacitors	8*	100nF / 400V	15MQ100 or 1/250A

 The quantity shown only pertains to the K6714 with an 8-relay output. Double the quantity if you wish to extend your standard module to a 16-relay output.

 (*) Simply double the quantity if you have the K6714-16 kit.

Schematic diagram

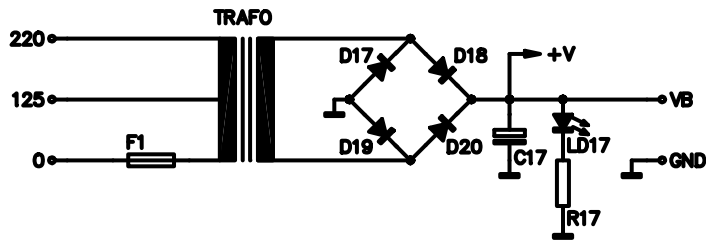
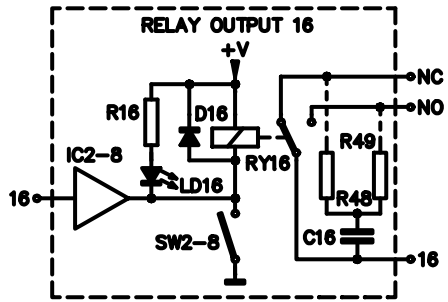
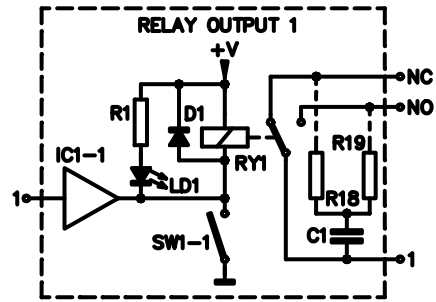
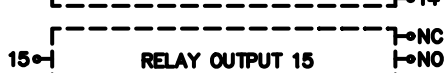
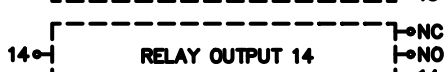
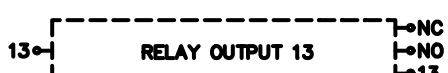
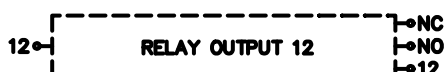
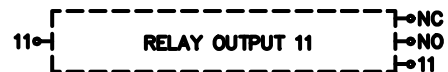
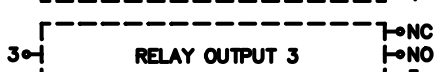
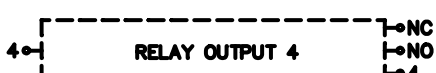
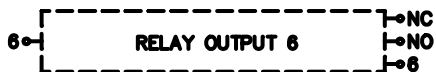

PCB

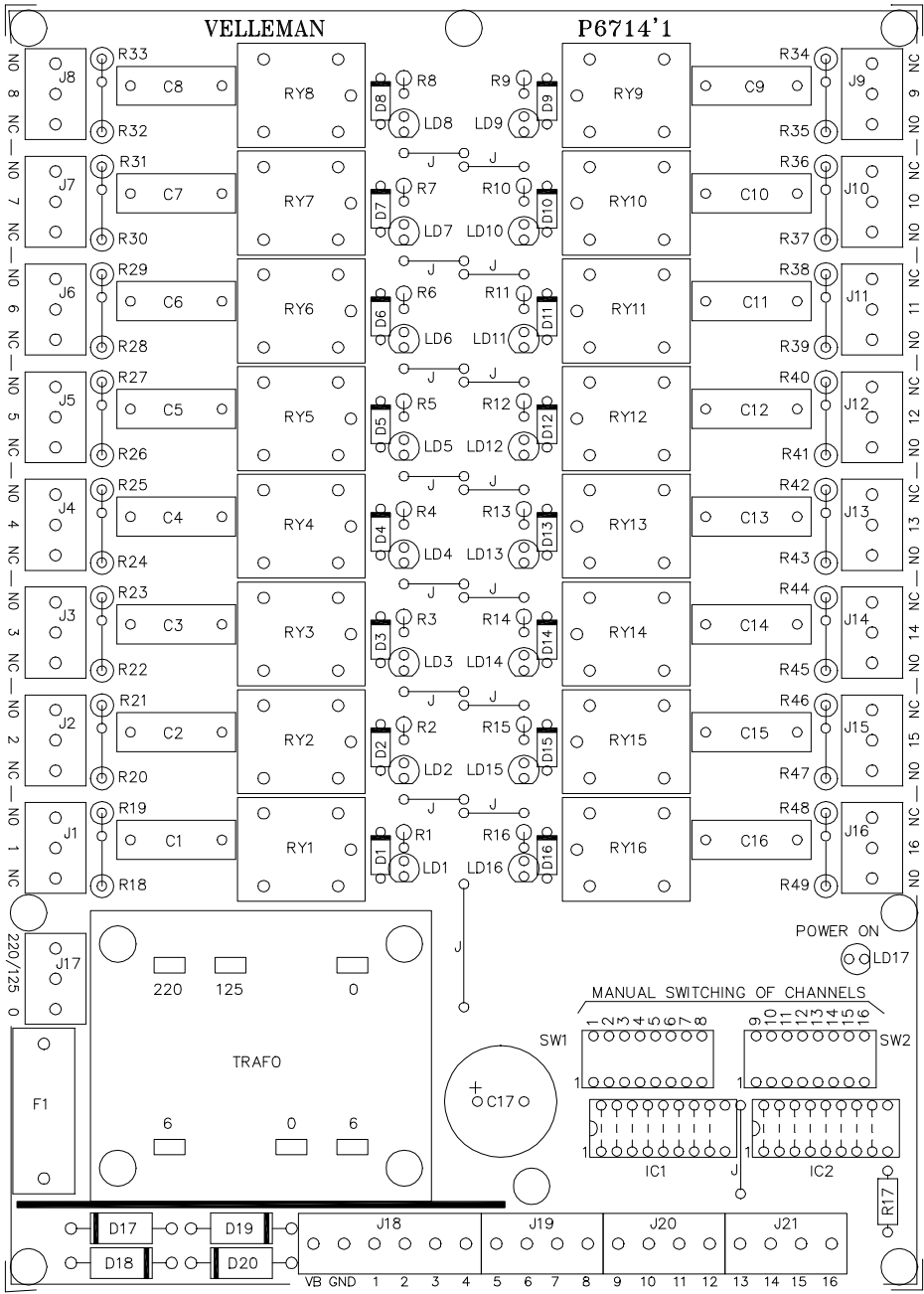

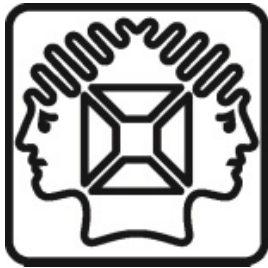

VELLEMAN NV
Legen Heirweg 33, B-9890 GAVERE
Belgium (Europe)