

Hyper 5 mm (T1 $\frac{3}{4}$) LED, Non Diffused Hyper-Bright LED

LB 5413, LV 5413, **LT 5413**



Vorläufige Daten / Preliminary Data

Besondere Merkmale

- **Gehäusetypp:** nicht eingefärbtes, klares 5 mm (T1 $\frac{3}{4}$) Gehäuse
- **Besonderheit des Bauteils:** enge Abstrahlcharakteristik für große Lichtstärken
- **Wellenlänge:** 470 nm (blau), 505 nm (verde), 528 nm (true green)
- **Abstrahlwinkel:** engwinklig (15°)
- **Technologie:** InGaN
- **optischer Wirkungsgrad:** 2 lm/W (blau), 6 lm/W (verde), 8 lm/W (true green)
- **Gruppierungsparameter:** Lichtstärke
- **Lötmethode:** Wellenlöten (TTW)
- **Verpackung:** Schüttgut, gegurtet lieferbar
- **ESD-Festigkeit:** ESD-sicher bis 2 kV nach EOS/ESD-5.1-1993

Anwendungen

- Ampelanwendungen
- Hinterleuchtung (LCD, Schalter, Tasten, Displays, Werbebeleuchtung, Allgemeinbeleuchtung)
- Innenbeleuchtung im Automobilbereich (z.B. Tastenbeleuchtung, u. ä.)
- Ersatz von Kleinst-Glühlampen

Features

- **package:** colorless, clear 5 mm (T1 $\frac{3}{4}$) package
- **feature of the device:** narrow viewing angle for more brightness
- **wavelength:** 470 nm (blue), 505 nm (verde), 528 nm (true green)
- **viewing angle:** narrow (15°)
- **technology:** InGaN
- **optical efficiency:** 2 lm/W (blue), 6 lm/W (verde), 8 lm/W (true green)
- **grouping parameter:** luminous intensity
- **soldering methods:** TTW soldering
- **packing:** bulk, available taped on reel
- **ESD-withstand voltage:** up to 2 kV acc. to EOS/ESD-5.1-1993

Applications

- traffic lights
- backlighting (LCD, switches, keys, displays, illuminated advertising, general lighting)
- interior automotive lighting (e.g. key backlighting, etc.)
- substitution of micro incandescent lamps

Typ Type	Emissions- farbe Color of Emission	Gehäusefarbe Color of Package	Lichtstärke Luminous Intensity $I_F = 20 \text{ mA}$ $I_V \text{ (mcd)}$	Lichtstrom Luminous Flux $I_F = 20 \text{ mA}$ $\Phi_V \text{ (mlm)}$	Bestellnummer Ordering Code
LB 5413-TV LB 5413-VBW	blue	colorless clear	280 ... 1120 710 ... 2800	120 (typ.) 300 (typ.)	Q62703-Q5930 Q62703-Q5931
LB 5413-T LB 5413-U LB 5413-V LB 5413-AW LB 5413-BW			280 ... 450 450 ... 710 710 ... 1120 1120 ... 1800 1800 ... 2800	60 (typ.) 100 (typ.) 150 (typ.) 240 (typ.) 380 (typ.)	
LV 5413-VBW LV 5413-BWDW LV 5413-V LV 5413-AW LV 5413-BW LV 5413-CW LV 5413-DW	verde	colorless clear	710 ... 2800 1800 ... 7100 710 ... 1120 1120 ... 1800 1800 ... 2800 2800 ... 4500 4500 ... 7100	470 (typ.) 1200 (typ.) 230 (typ.) 370 (typ.) 590 (typ.) 900 (typ.) 1400 (typ.)	Q62703-Q5932 Q62703-Q5933
LT 5413-VBW LT 5413-BWDW LT 5413-V LT 5413-AW LT 5413-BW LT 5413-CW LT 5413-DW	true green	colorless clear	710 ... 2800 1800 ... 7100 710 ... 1120 1120 ... 1800 1800 ... 2800 2800 ... 4500 4500 ... 7100	470 (typ.) 1200 (typ.) 230 (typ.) 370 (typ.) 590 (typ.) 900 (typ.) 1400 (typ.)	Q62703-Q5934 Q62703-Q5935

Anm.: - gesamter Farbbereich, Lieferung in Einzelgruppen (siehe Seite 5)

Die Standardlieferform von Serientypen beinhaltet eine untere bzw. eine obere Familiengruppe oder mindestens zwei Einzelgruppen.

In einer Verpackungseinheit / Gurt ist immer nur eine Helligkeitsgruppe enthalten.

Die technologiebedingte Helligkeits-Streuung der heutigen LED-Herstellprozesse über einen längeren Fertigungszeitraum (Halbleitermaterial - Chipherstellung - Montageprozesses) erlaubt keine Zusage einer einzelnen Helligkeitsgruppe. Daher müssen mindestens zwei Helligkeitsgruppen vorgesehen werden!

Note: - Total color tolerance range, delivery in single groups (please see page 5)

The standard shipping format for serial types includes a lower or upper family group or at least two individual groups.

No packing unit / tape ever contains more than one luminous intensity group.

Luminosity variations caused by the technology used in current LED manufacturing processes over a protracted manufacturing period (semiconductor material - chip fabrication - assembly process) mean that it is not possible to assign LEDs to a single luminous intensity group. For this reason at least two luminous intensity groups must be provided!

Grenzwerte
Maximum Ratings

Bezeichnung Parameter	Symbol Symbol	Wert Value		Einheit Unit
		LB	LV, LT	
Betriebstemperatur Operating temperature range	T_{op}	- 55 ... + 100		°C
Lagertemperatur Storage temperature range	T_{stg}	- 55 ... + 100		°C
Sperrschichttemperatur Junction temperature	T_j	+ 100		°C
Durchlassstrom Forward current	I_F	20		mA
Stoßstrom Surge current $t \leq 10 \mu s, D = 0.005$	I_{FM}	200	250	mA
Sperrspannung Reverse voltage	V_R	5		V
Leistungsaufnahme Power consumption $T_A \leq 25 \text{ °C}$	P_{tot}	85		mW
Wärmewiderstand Thermal resistance Sperrschicht/Umgebung Junction/ambient	$R_{th JA}$	400		K/W
Sperrschicht/Löt­pad Junction/solder point Montage auf PC-Board FR 4 (Padgröße $\geq 16 \text{ mm}^2$) mounted on PC board FR 4 (pad size $\geq 16 \text{ mm}^2$) Minimale Beinchenlänge Minimum lead length	$R_{th JS}$	180		K/W

Kennwerte ($T_A = 25\text{ °C}$)
Characteristics

Bezeichnung Parameter	Symbol Symbol	Werte Values			Einheit Unit
		LB	LV	LT	
Wellenlänge des emittierten Lichtes (typ.) Wavelength at peak emission $I_F = 20\text{ mA}$	λ_{peak}	465	503	523	nm
Dominantwellenlänge ¹⁾ (typ.) Dominant wavelength $I_F = 20\text{ mA}$	λ_{dom}	470 ± 6	505 ± 7	528 ± 9	nm
Spektrale Bandbreite bei 50 % $I_{\text{rel max}}$ (typ.) Spectral bandwidth at 50 % $I_{\text{rel max}}$ $I_F = 20\text{ mA}$	$\Delta\lambda$	25	30	33	nm
Abstrahlwinkel bei 50 % I_V (Vollwinkel) (typ.) Viewing angle at 50 % I_V	2ϕ	15	15	15	Grad deg.
Durchlassspannung ²⁾ (typ.) Forward voltage $I_F = 20\text{ mA}$	V_F V_F	3.5 4.1	3.3 4.1	3.3 4.1	V V
Sperrstrom (typ.) Reverse current $V_R = 5\text{ V}$	I_R I_R	0.01 10	0.01 10	0.01 10	μA μA
Temperaturkoeffizient von λ_{peak} (typ.) Temperature coefficient of λ_{peak} $I_F = 20\text{ mA}; -10\text{ °C} \leq T \leq 100\text{ °C}$	$TC_{\lambda_{\text{peak}}}$	0.04	0.03	0.04	nm/K
Temperaturkoeffizient von λ_{dom} (typ.) Temperature coefficient of λ_{dom} $I_F = 20\text{ mA}; -10\text{ °C} \leq T \leq 100\text{ °C}$	$TC_{\lambda_{\text{dom}}}$	0.02	0.02	0.03	nm/K
Temperaturkoeffizient von V_F (typ.) Temperature coefficient of V_F $I_F = 20\text{ mA}; -10\text{ °C} \leq T \leq 100\text{ °C}$	TC_V	- 2.9	- 3.2	- 3.6	mV/K
Optischer Wirkungsgrad (typ.) Optical efficiency $I_F = 20\text{ mA}$	η_{opt}	2	6	8	lm/W

¹⁾ Wellenlängengruppen werden mit einer Stromeinprägedauer von 25 ms und einer Genauigkeit von $\pm 1\text{ nm}$ ermittelt.
Wavelength groups are tested at a current pulse duration of 25 ms and a tolerance of $\pm 1\text{ nm}$.

²⁾ Spannungswerte werden mit einer Stromeinprägedauer von 1 ms und einer Genauigkeit von $\pm 0.1\text{ V}$ ermittelt.
Voltages are tested at a current pulse duration of 1 ms and a tolerance of $\pm 0.1\text{ V}$.

1) Wellenlängengruppen / Wavelength groups

Gruppe Group	blue		verde		true green		Einheit Unit
	min.	max.	min.	max.	min.	max.	
3	464	468	498	503	519	525	nm
4	468	472	503	507	525	531	nm
5	472	476	507	512	531	537	nm

Helligkeits-Gruppierungsschema
Luminous Intensity Groups

Lichtgruppe Luminous Intensity Group	Lichtstärke Luminous Intensity I_V (mcd)	Lichtstrom Luminous Flux Φ_V (lm)
T	280 ... 450	60 (typ.)
U	450 ... 710	100 (typ.)
V	710 ... 1120	150 (typ.)
AW	1120 ... 1800	240 (typ.)
BW	1800 ... 2800	380 (typ.)
CW	2800 ... 4500	900 (typ.)
DW	4500 ... 7100	1400 (typ.)

Helligkeitswerte werden mit einer Stromeinprägedauer von 25 ms und einer Genauigkeit von $\pm 11\%$ ermittelt.
Luminous intensity is tested at a current pulse duration of 25 ms and a tolerance of $\pm 11\%$.

Relative spektrale Emission $I_{rel} = f(\lambda)$, $T_A = 25\text{ }^\circ\text{C}$, $I_F = 20\text{ mA}$

Relative Spectral Emission

$V(\lambda)$ = spektrale Augenempfindlichkeit
Standard eye response curve

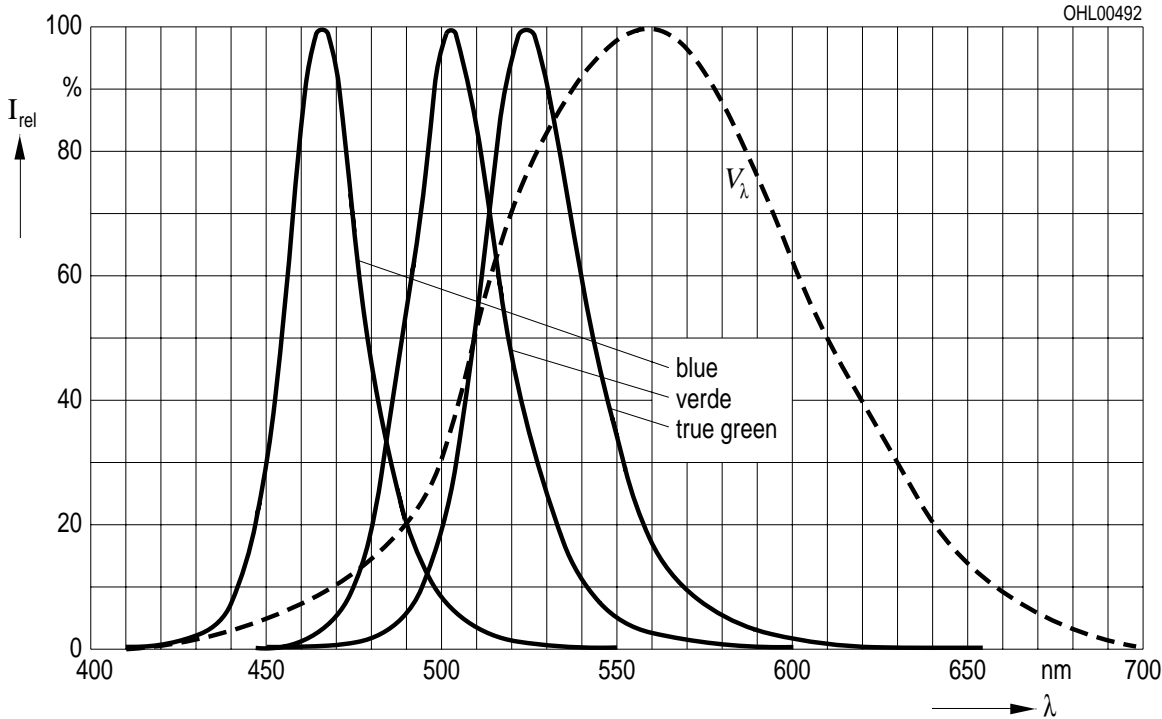

Abstrahlcharakteristik $I_{rel} = f(\varphi)$

Radiation Characteristic

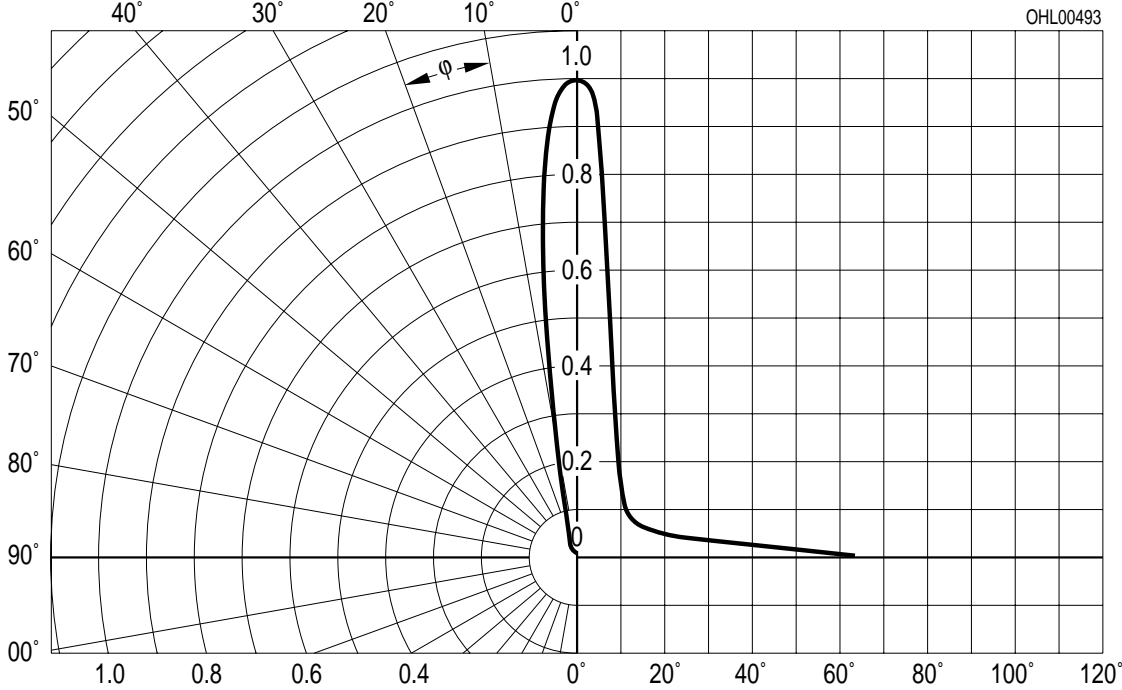

Durchlassstrom $I_F = f(V_F)$

Forward Current

$T_A = 25\text{ }^\circ\text{C}$

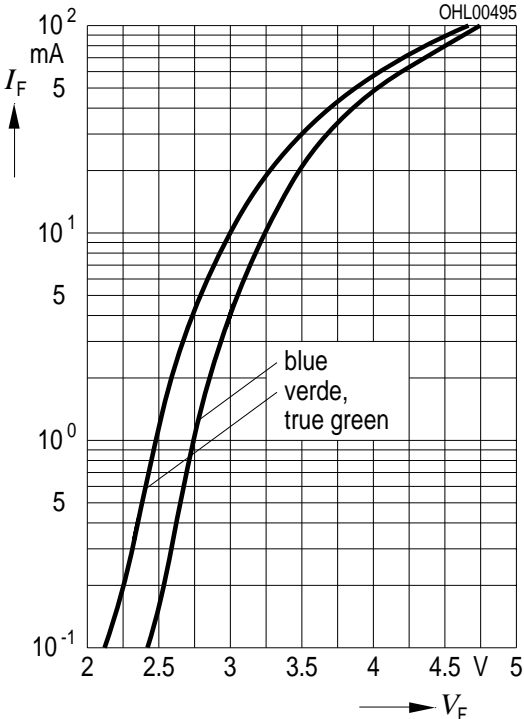

Relative Lichtstärke $I_V/I_{V(20\text{ mA})} = f(I_F)$

Relative Luminous Intensity

$T_A = 25\text{ }^\circ\text{C}$

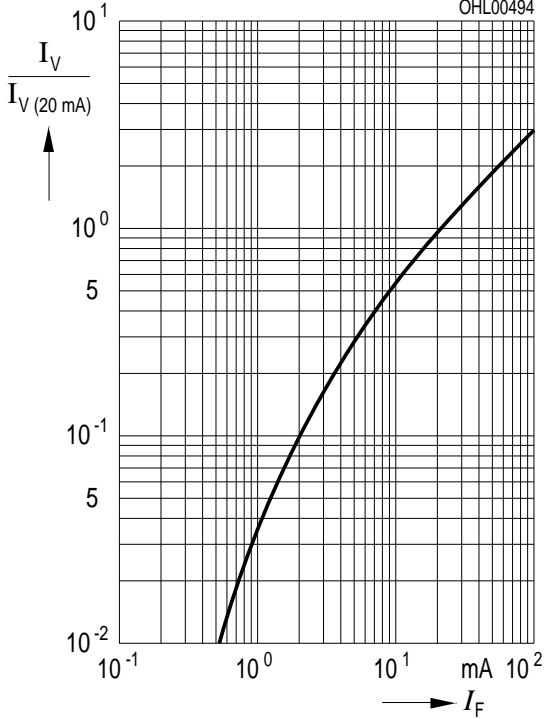

Maximal zulässiger Durchlassstrom $I_F = f(T)$

Max. Permissible Forward Current

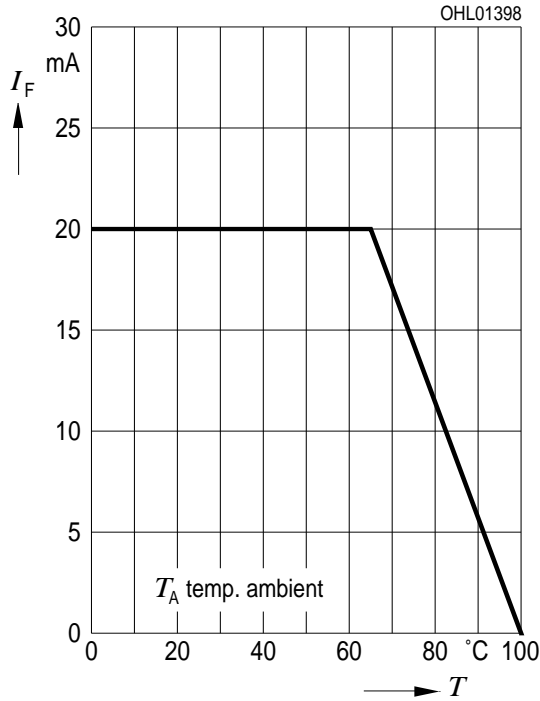

Maximal zulässiger Durchlassstrom $I_F = f(T)$

Max. Permissible Forward Current

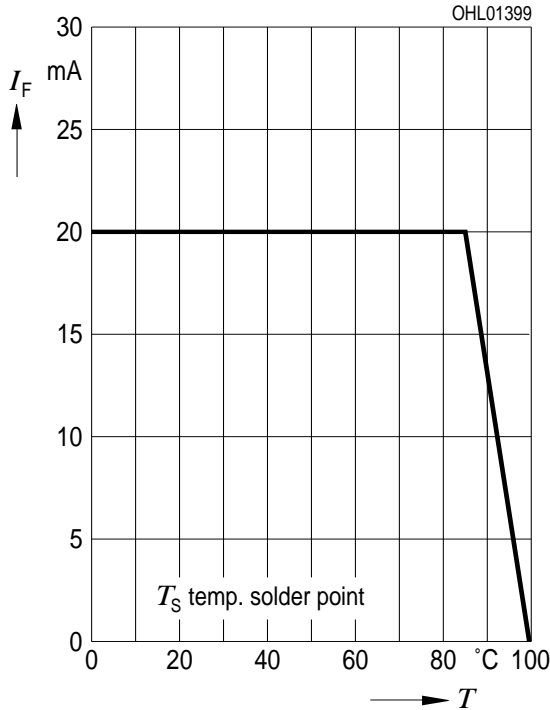

Relative Lichtstärke $I_V/I_{V(25\text{ °C})} = f(T_A)$
 Relative Luminous Intensity

$I_F = 20\text{ mA}$

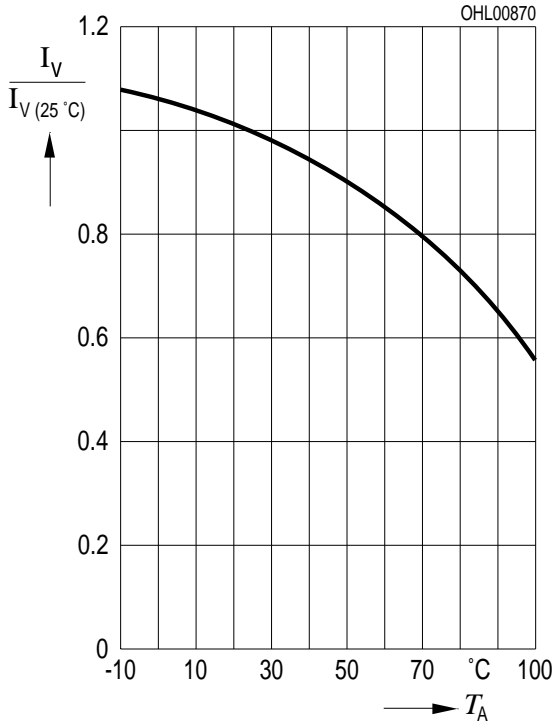

Dominante Wellenlänge $\lambda_{\text{dom}} = f(I_F)$
 Dominant Wavelength

LB, $T_A = 25\text{ °C}$

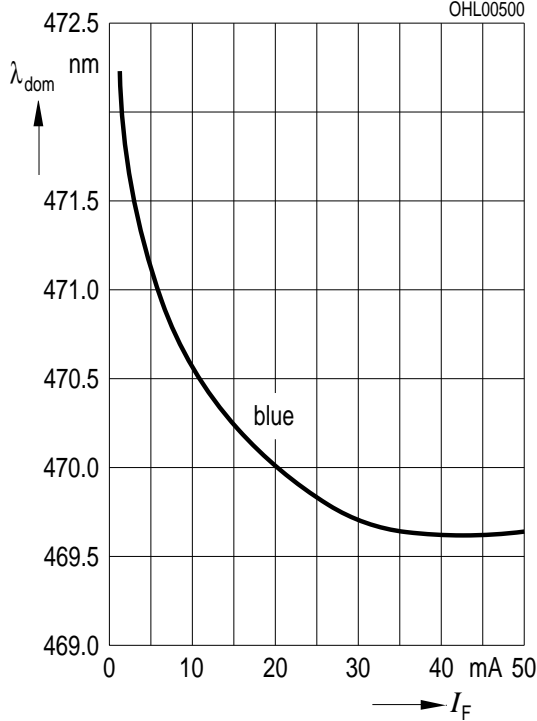

Dominante Wellenlänge $\lambda_{\text{dom}} = f(I_F)$
 Dominant Wavelength

LV, $T_A = 25\text{ °C}$

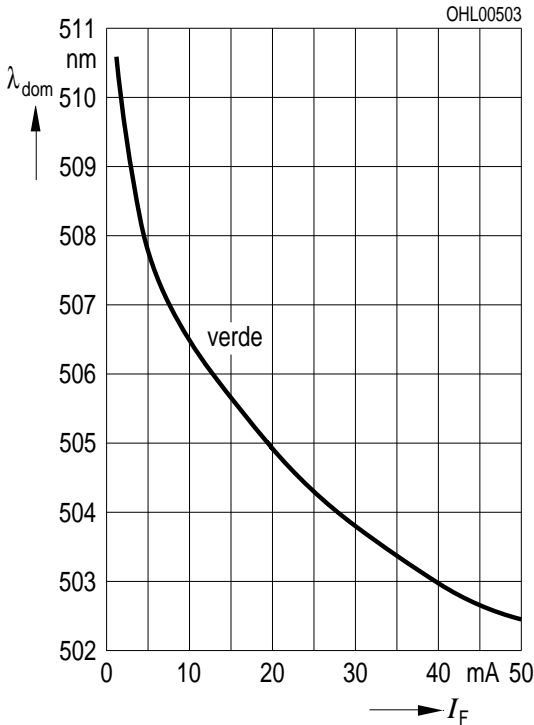

Dominante Wellenlänge $\lambda_{\text{dom}} = f(I_F)$
 Dominant Wavelength

LT, $T_A = 25\text{ °C}$

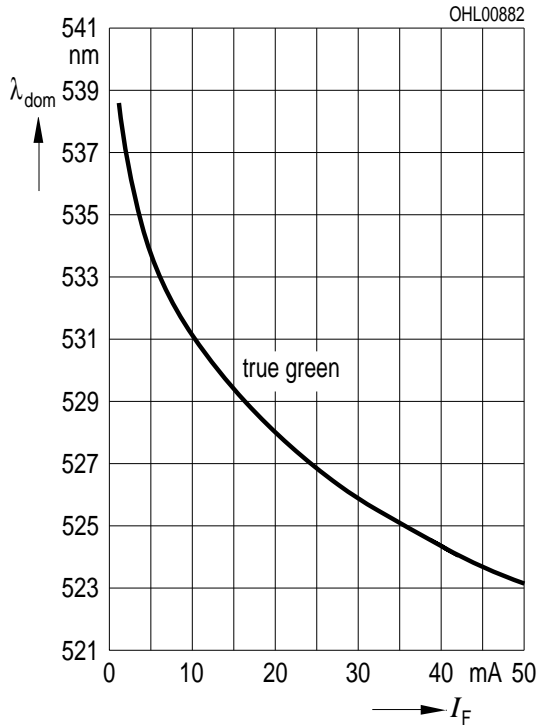

Zulässige Impulsbelastbarkeit $I_F = f(t_p)$
Permissible Pulse Handling Capability
 Duty cycle $D =$ parameter, $T_A = 25\text{ °C}$
LB

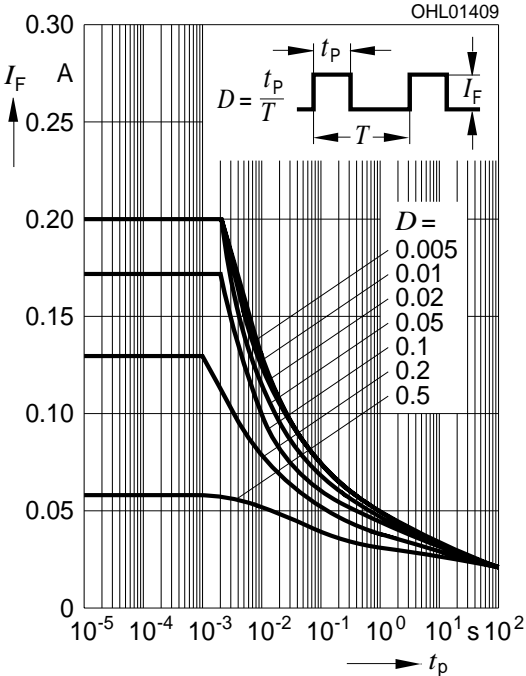

Zulässige Impulsbelastbarkeit $I_F = f(t_p)$
Permissible Pulse Handling Capability
 Duty cycle $D =$ parameter, $T_A = 85\text{ °C}$
LB

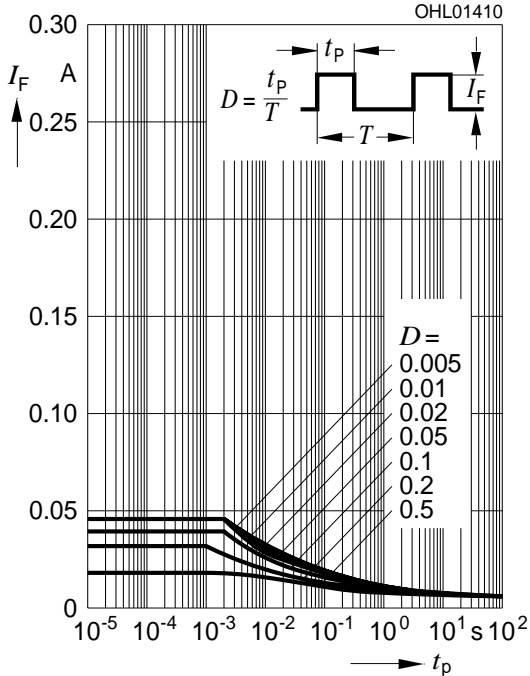

Zulässige Impulsbelastbarkeit $I_F = f(t_p)$
Permissible Pulse Handling Capability
 Duty cycle $D =$ parameter, $T_A = 25\text{ °C}$
LV, LT

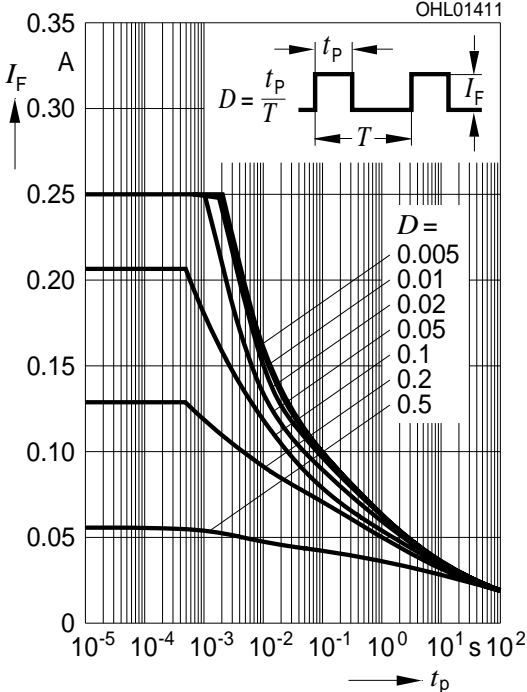

Zulässige Impulsbelastbarkeit $I_F = f(t_p)$
Permissible Pulse Handling Capability
 Duty cycle $D =$ parameter, $T_A = 85\text{ °C}$
LV, LT

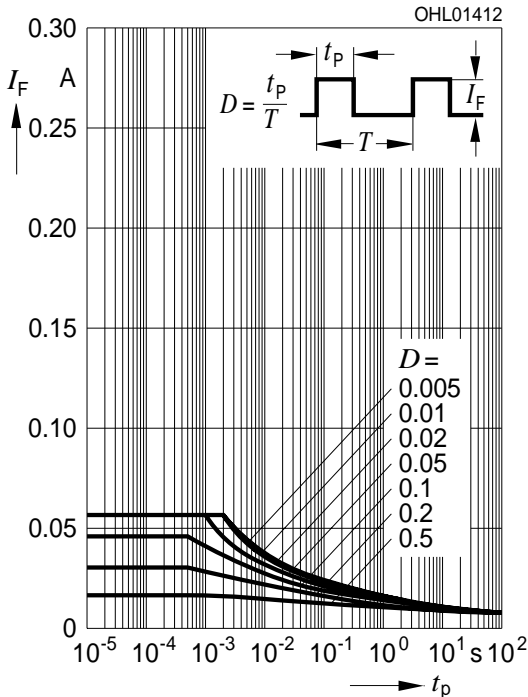

Maßzeichnung
Package Outlines

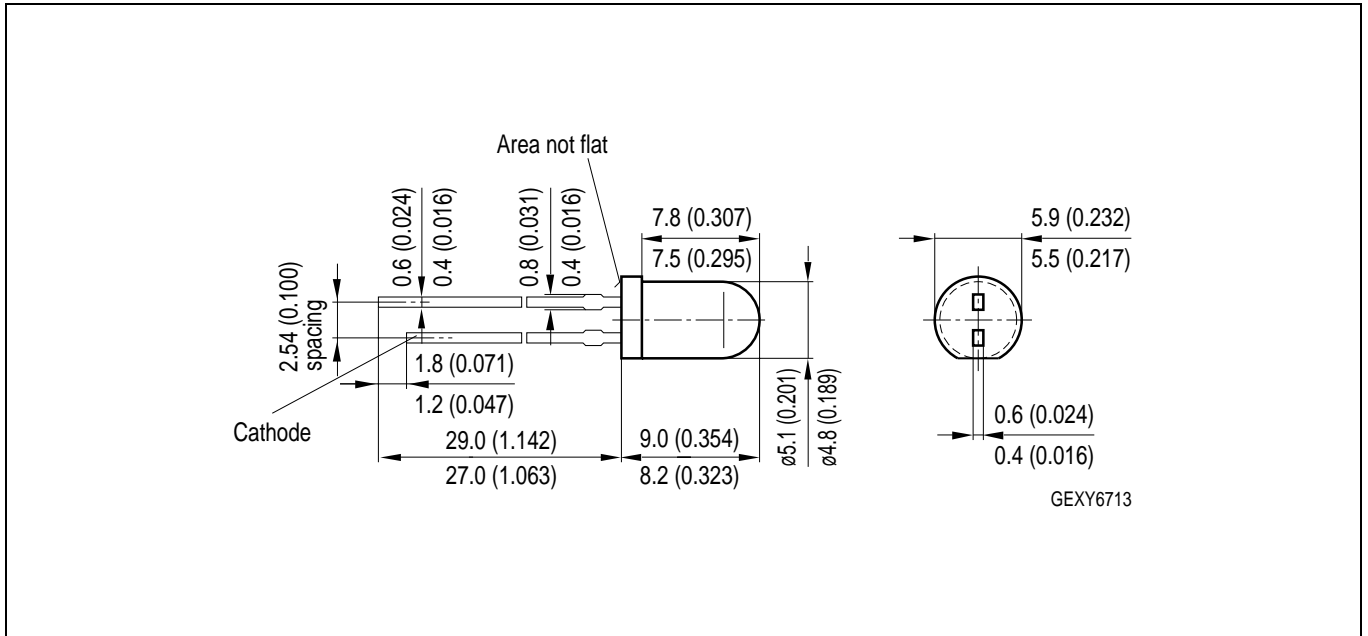

Maße werden wie folgt angegeben: mm (inch) / Dimensions are specified as follows: mm (inch).

Kathodenkennung: kürzerer Lötspieß
Cathode mark: short solder lead
Gewicht / Approx. weight: 0.35 g

Lötbedingungen
Soldering Conditions

Wellenlöten (TTW)(nach CECC 00802)
TTW Soldering(acc. to CECC 00802)

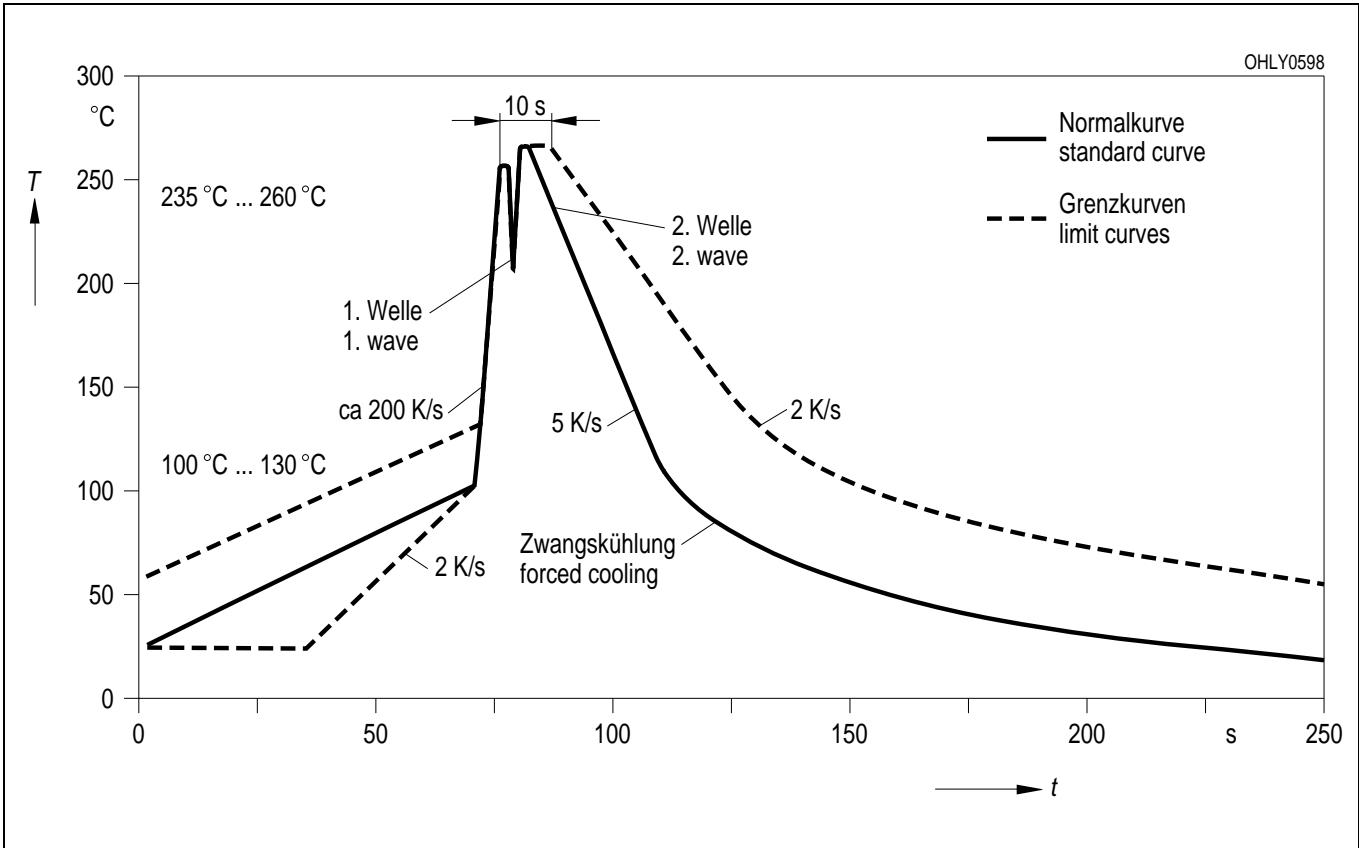

Empfohlenes Lötpaddesign Wellenlöten (TTW)
Recommended Solder Pad TTW Soldering

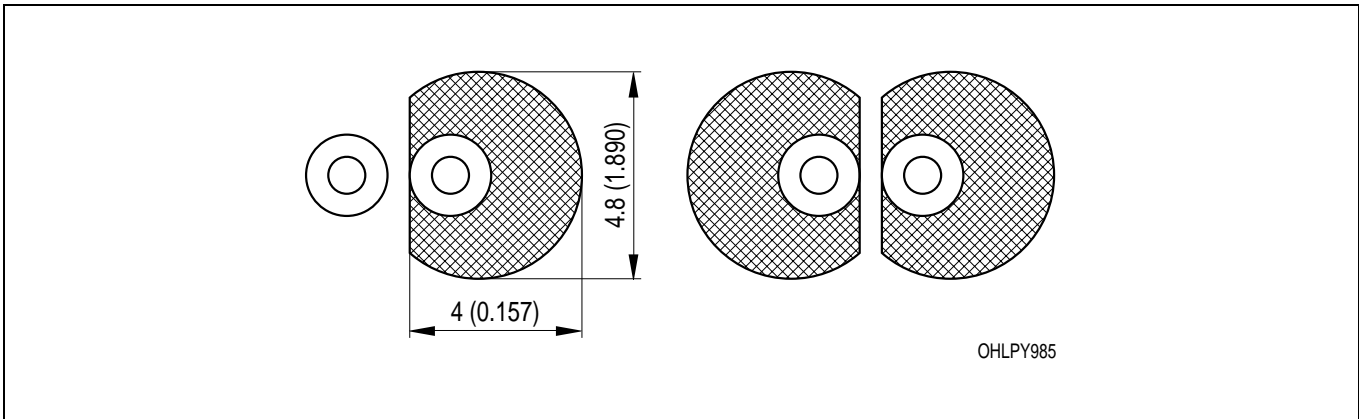

Maße werden wie folgt angegeben: mm (inch) / Dimensions are specified as follows: mm (inch).

Revision History: 2001-03-01

Previous Version: 2001-03-01

Page	Subjects (major changes since last revision)

Published by OSRAM Opto Semiconductors GmbH & Co. OHG

Wernerwerkstrasse 2, D-93049 Regensburg

© All Rights Reserved.

Attention please!

The information describes the type of component and shall not be considered as assured characteristics.

Terms of delivery and rights to change design reserved. Due to technical requirements components may contain dangerous substances. For information on the types in question please contact our Sales Organization.

If printed or downloaded, please find the latest version in the Internet.

Packing

Please use the recycling operators known to you. We can also help you – get in touch with your nearest sales office. By agreement we will take packing material back, if it is sorted. You must bear the costs of transport. For packing material that is returned to us unsorted or which we are not obliged to accept, we shall have to invoice you for any costs incurred.

Components used in life-support devices or systems must be expressly authorized for such purpose! Critical components ¹ may only be used in life-support devices or systems ² with the express written approval of OSRAM OS.

¹ A critical component is a component used in a life-support device or system whose failure can reasonably be expected to cause the failure of that life-support device or system, or to affect its safety or the effectiveness of that device or system.

² Life support devices or systems are intended (a) to be implanted in the human body, or (b) to support and/or maintain and sustain human life. If they fail, it is reasonable to assume that the health of the user may be endangered.