



0.4" Blue LED Numeric Displays

LTS-4X01B

LTD-4000B

Series

LTC-4000B

Features

- 0.4 inch (10.0mm) digit height
- Continuous uniform segments.
- Low power requirement.
- Excellent characters appearance.
- Solid state reliability.
- Wide viewing angle.
- Categorized for luminous intensity.
- I.C. compatible.
- Easy mounting on P.C. board or socket.

Description

The LTS-4X01B, LTD-4000B, LTC-4000B series are 0.4 inch (10.0mm) height seven segment single, dual, triple and quadruple digit displays.

The blue series devices utilize LED chips which are made from GaN on a SiC substrate. The devices have gray face and white segments.

Package Dimensions

A.LTS-4301B/4801B

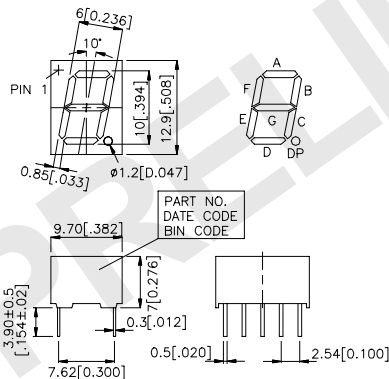

B.LTD-4608B/4708B

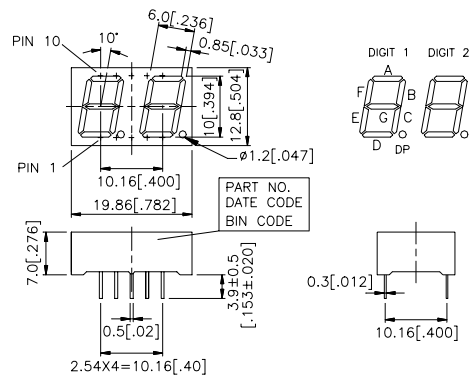

C.LTC-4624B/4724B

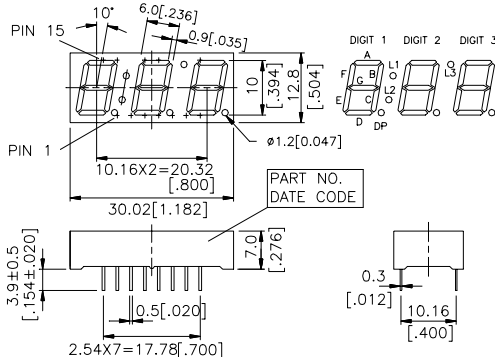

D.LTC-4627B/4727B

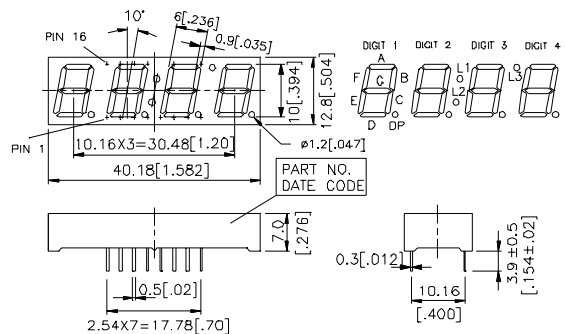

Notes: All dimensions are in millimeters (inches). Tolerance: $\pm 0.25\text{mm}$ ($\pm 0.01''$) unless otherwise noted.

Devices

Part No.	Description	Package Dimension	Internal Circuit Diagram
blue			
LTS-4301B	Common Cathode, Rt. Hand Decimal	A	A
LTS-4801B	Common Anode, Rt. Hand Decimal	A	B
LTD-4608B	Dualplex Common Anode, Rt. Hand Decimal	B	C
LTD-4708B	Dualplex Common Cathode, Rt. Hand Decimal	B	D
LTC-4624B	Multiplex Common Anode, Rt. Hand Decimal	C	E
LTC-4724B	Multiplex Common Cathode, Rt. Hand Decimal	C	F
LTC-4627B	Multiplex Common Anode, Rt. Hand Decimal	D	G
LTC-4727B	Common Common Cathode, Rt. Hand Decimal	D	H

Pin Connection

Pin No.	Connection	
	A.LTS-4301B	B.LTS-4801B
1.	Anode G	Cathode G
2.	Anode F	Cathode F
3.	Common Cathode	Common Anode
4.	Anode E	Cathode E
5.	Anode D	Cathode D
6.	Anode D.P.	Cathode D.P.
7.	Anode C	Cathode C
8.	Common Cathode	Common Anode
9.	Anode B	Cathode B
10.	Anode A	Cathode A

Pin No.	Connection	
	C.LTD-4608B	D.LTD-4708B
1.	Cathode C	Anode C
2.	Cathode D.P.	Anode D.P.
3.	Cathode E	Anode E
4.	Common Anode Digit 2	Common Cathode Digit 2
5.	Cathode D	Anode D
6.	Cathode F	Anode F
7.	Cathode G	Anode G
8.	Cathode B	Anode B
9.	Common Anode Digit 1	Common Cathode Digit 1
10.	Cathode A	Anode A

Pin No.	Connection	
	E.LTC-4624B	F.LTC-4724B
1.	Common Anode Digit 1	Common Cathode Digit 1
2.	Cathode E	Anode E
3.	Cathode C, L3	Anode C, L3
4.	Cathode D	Anode D
5.	Common Anode Digit 2	Common Cathode Digit 2
6.	Cathode D.P.	Anode D.P.
7.	Common Anode Digit 3	Common Cathode Digit 3
8.	Cathode G	Anode G
9.	No Pin	No Pin
10.	No Pin	No Pin
11.	Cathode B, L2	Anode B, L2
12.	Cathode A, L1	Anode A, L1
13.	No Pin	No Pin
14.	Common Anode L1, L2, L3	Common Cathode L1, L2, L3
15.	Cathode F	Anode F

Pin No.	Connection	
	G.LTC-4627B	H.LTC-4727B
1.	Common Anode Digit 1	Common Cathode Digit 1
2.	Common Anode Digit 2	Common Cathode Digit 2
3.	Cathode D	Anode D
4.	Common Anode L1, L2, L3	Common Cathode L1, L2, L3
5.	Cathode E	Anode E
6.	Common Anode Digit 3	Common Cathode Digit 3
7.	Cathode D.P.	Anode D.P.
8.	Common Anode Digit 4	Common Cathode Digit 4
9.	No Connection	No Connection
10.	No Pin	No Pin
11.	Cathode F	Anode F
12.	No Pin	No Pin
13.	Cathode C, L3	Anode C, L3
14.	Cathode A, L1	Anode A, L1
15.	Cathode G	Anode G
16.	Cathode B, L2	Anode B, L2

Internal Circuit Diagrams

A.LTS-4301B

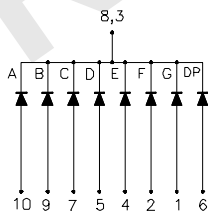

B.LTS-4801B

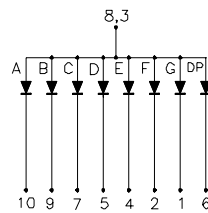

C.LTD-4608B

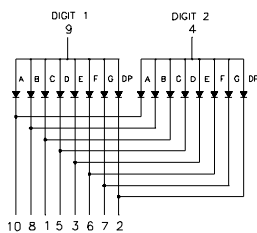

D.LTD-4708B

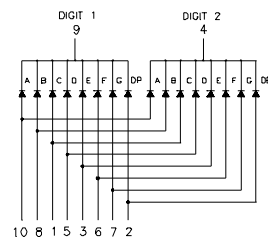

E.LTC-4624B

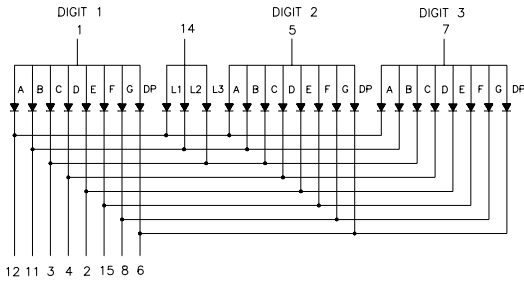

F.LTC-4724B

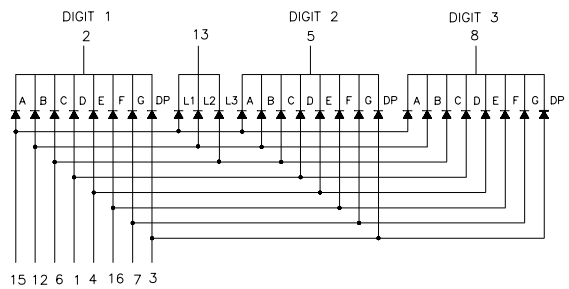

G.LTC-4627B

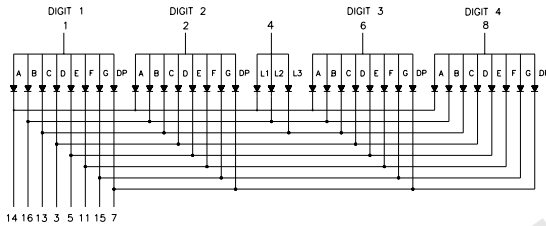

H.LTC-4727B

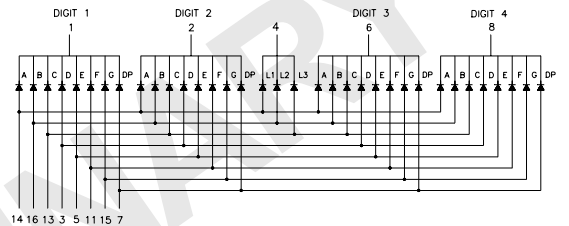

BLUE PRODUCTS

Absolute Maximum Rating at Ta=25°C

Parameter	Blue	Unit
Power Dissipation Per Segment	65	mW
Peak Forward Current Per Segment (1/10 Duty Cycle, 0.1ms Pulse Width)	60	mA
Continuous Forward Current Per Segment Derating Linear from 25°C Per Segment	15 0.2	mA mA/°C
Reverse Voltage Per Segment	5	V
Operating Temperature Range	-35°C to +85°C	
Storage Temperature Range	-35°C to +85°C	
Solder Temperature 1/16 Inch Below Seating Plane for 3 Seconds at 260°C		

Electrical/Optical Characteristics at Ta=25°C

Parameter	Symbol	Min.	Typ.	Max.	Unit	Test Condition
Average Luminous Intensity	I _v	1200	3600		μ cd	I _F =10mA
Peak Emission Wavelength	λ _P		428		nm	I _F =20mA
Spectral Line Half-Width	Δλ		65		nm	I _F =20mA
Dominant Wavelength	λ _d		466		nm	I _F =20mA
Forward Voltage, Per Segment	V _F		3.8	4.5	V	I _F =20mA
Reverse Current, Per Segment	I _R			100	μ A	V _R =5V
Luminous Intensity Matching Ratio	I _v -m			2:1		I _F =10mA

Notes: Luminous intensity is measured with a light sensor and filter combination that approximates the CIE (Commission Internationale de l'Eclairage) eye-response curve.

Typical Electrical/Optical Characteristic Curves (25°C Ambient Temperature Unless Otherwise Noted)

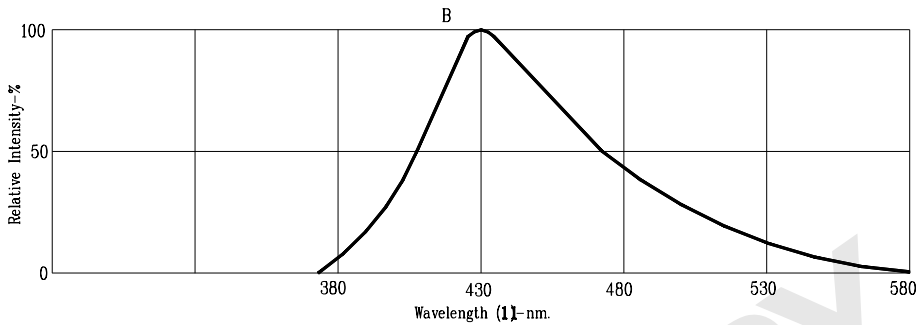

Fig1. RELATIVE INTENSITY VS. WAVELENGTH

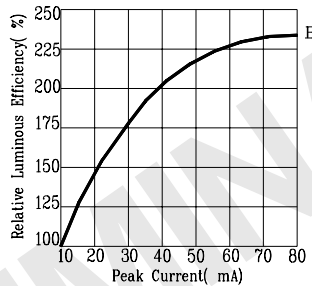

Fig2. RELATIVE LUMINOUS EFFICIENCY VS. PEAK FORWARD CURRENT (125us pulse width; 1ms period)

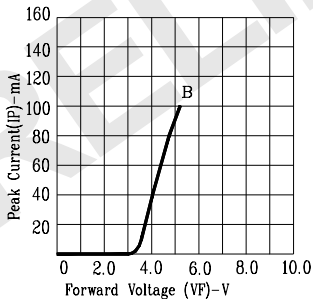

Fig3. FORWARD CURRENT VS. FORWARD VOLTAGE

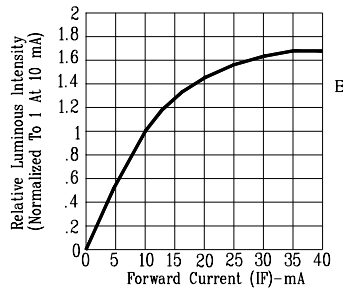

Fig4. RELATIVE LUMINOUS INTENSITY VS. FORWARD CURRENT

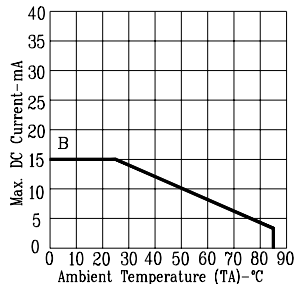

Fig5. MAX. ALLOWABLE DC CURRENT VS. AMBIENT TEMPERATURE.

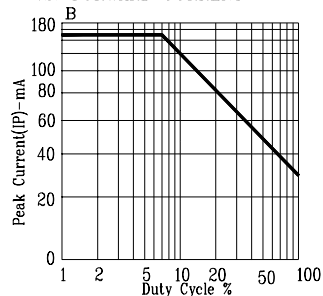

Fig6. MAX. PEAK CURRENT VS. DUTY CYCLE % (REFRESH RATE 1KHz)

NOTE: B= BLUE (REFRESH RATE 1KHz)