

Pololu QTR Reflectance Sensor Application Note

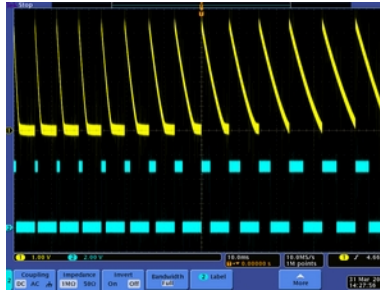

1. QTR-xRC Sensor Output (Intended for Digital I/Os)	2
2. QTR-xA Sensor Output (Analog Voltages)	4

1. QTR-xRC Sensor Output (Intended for Digital I/Os)

Each **QTR-1RC** [<http://www.pololu.com/catalog/product/959>] and **QTR-8RC** [<http://www.pololu.com/catalog/product/961>] reflectance sensor phototransistor output is tied to a capacitor discharge circuit as shown on the right, which allows a digital I/O line on a microcontroller to take an analog reflectance reading by measuring the discharge time of the capacitor. When you have a microcontroller’s digital I/O connected to a sensor output, the typical sequence for reading that sensor is:

1. Set the I/O line to an output and drive it high
2. Allow at least 10 us for the 10 nF capacitor to charge
3. Make the I/O line an input (high impedance)
4. Measure the time for the capacitor to discharge by waiting for the I/O line to go low

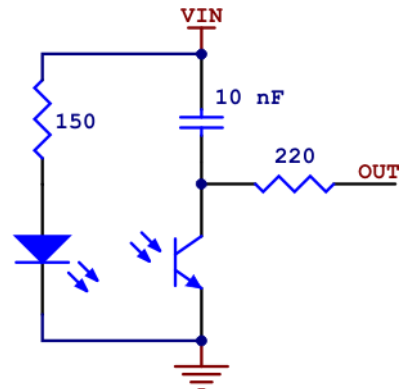

QTR-1RC reflectance sensor schematic diagram.

The following three oscilloscope screen captures below demonstrate the result of this procedure. The sensor was positioned 1/8" above a whiteboard-like surface with a 3/4" thick piece of black electrical tape on it. The first reading was taken over the white portion of the surface, the second reading was taken at the edge of the tape, and the third was taken while fully over the black tape. The yellow oscilloscope channel is the sensor output and the blue oscilloscope channel is the output of a mega168 AVR microcontroller representing its interpretation of the sensor output. A 5 V blue signal indicates that the AVR is measuring the sensor output as “high”; a 0 V blue signal indicates that the AVR is measuring the sensor output as “low”. In an actual application, the important value is the width of the positive blue pulse. As you can see from the screen captures, the shorter the pulse, the more reflective the surface. Medium-width pulses occur from moderately reflective surfaces, or as you transition from a white surface to a black surface (or vice versa).

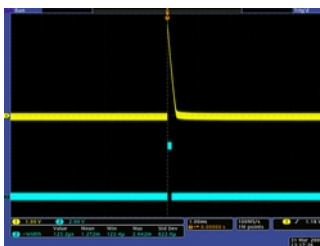

QTR-1RC output (yellow) when 1/8" above a white surface and microcontroller timing of that output (blue).

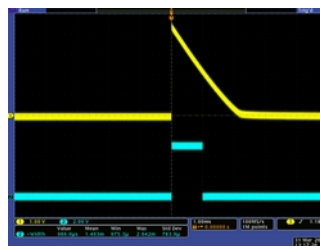

QTR-1RC output (yellow) when 1/8" above a white/black interface and mcu timing of that output (blue).

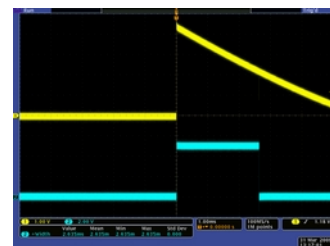

QTR-1RC output (yellow) when 1/8" above a black line and microcontroller timing of that output (blue).

Please note that these data are affected by the specifics of the test. Reflectances depend on the surfaces, and each microcontroller will have its own trip-low threshold. In our specific example, you can see that at a height of 1/8" above our surface, white results in a high pulse width of 120 us and black results in a high pulse width of 2.6 ms. As the pulse width varies between 120 us and 2.6 ms, you can tell that you are approaching or leaving the line.

The screen captures below show the results of the same test conducted at a sensor height of 3/8".

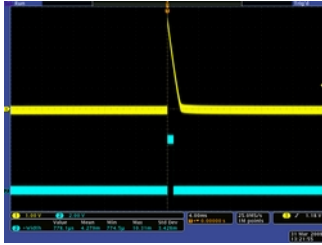

QTR-IRC output (yellow) when 3/8" above a white surface and microcontroller timing of that output (blue).

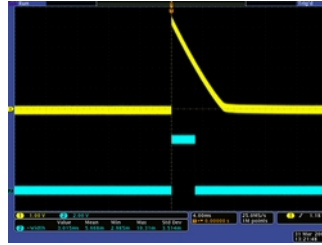

QTR-IRC output (yellow) when 3/8" above a white/black interface and mcu timing of that output (blue).

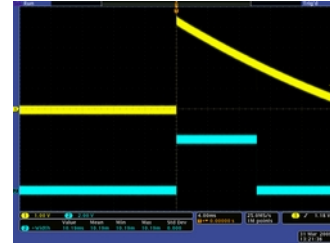

QTR-IRC output (yellow) when 3/8" above a black line and microcontroller timing of that output (blue).

Raising the sensor decreases the overall reflectance of the surface, which in turn lengthens all of the positive pulse widths. This means we need more time to measure the sensor outputs and hence we are limited to lower update rates. At this height, our white surface results in a high pulse width of 780 us and our black surface results in a high pulse width of 10 ms.

Note that at the start of each yellow pulse, there is a 10 us period where our microcontroller is driving the sensor output line high.

Lastly, the following screen capture shows an example of what the sensor output might look like as it sweeps across a black line on a white surface. A motor was used to rotate a white paper disk with a piece of black electrical tape on it in front of the sensor. The electrical noise present in the screen capture is from this motor. If you will be using these sensors in electrically noisy environments (e.g. around motors), you should filter the signal either with a low-pass filter circuit or in your microcontroller software. For example, when timing the high (blue) pulse, wait until the signal stays low for a minimum duration (e.g. 10 us) before accepting the low signal as the end of the pulse.

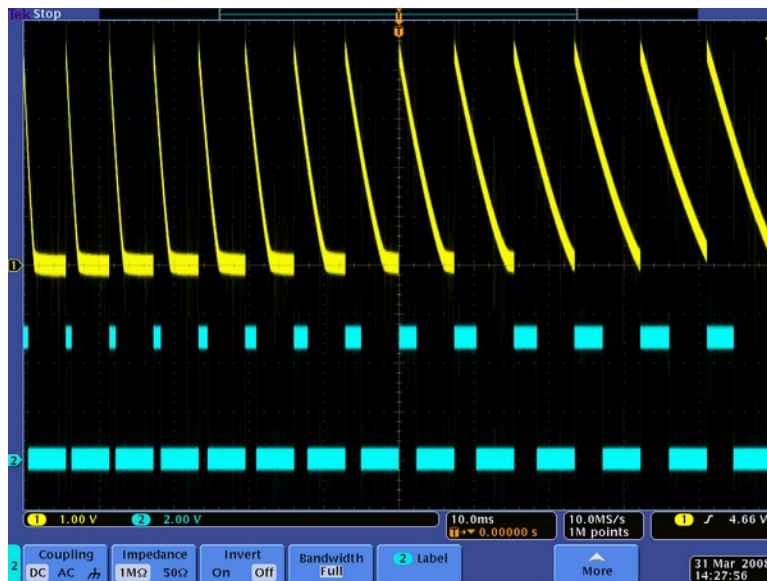

Example series of QTR-IRC output signals generated as a black line on a spinning white disk passes in front of the sensor.

2. QTR-xA Sensor Output (Analog Voltages)

Each **QTR-1A** [<http://www.pololu.com/catalog/product/958>] and **QTR-8A** [<http://www.pololu.com/catalog/product/960>] reflectance sensor phototransistor output is connected to a pull-up resistor as shown below to form a voltage divider that produces an analog voltage output that ranges between 0 V and the supplied voltage (which is typically 5 V). With a strong reflectance, such as when the sensor is over a white surface, its output voltage will tend towards 0 V; with very weak reflectance, such as when the sensor is over a black surface, its output voltage will tend towards the supplied voltage.

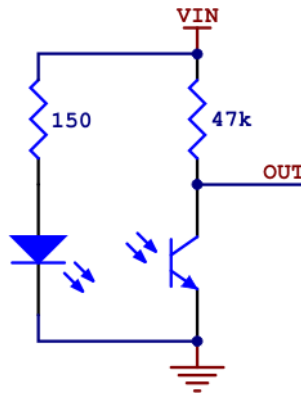

QTR-1A reflectance sensor schematic diagram.

To demonstrate what the QTR-xA sensor output looks like as it passes from a reflective surface to a non-reflective surface and back again, we set up a motor to spin a white paper circle with a piece of black electrical tape on it as shown below.

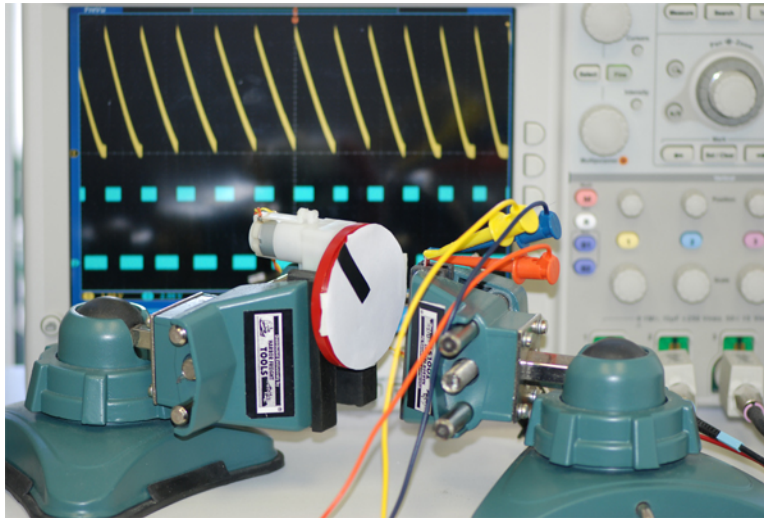

Experimental setup for **QTR-1A** and QTR-1RC oscilloscope outputs.

The following three oscilloscope screen captures show the output of the QTR-xA reflectance sensor during the period where the black line passes by the sensor. The oscilloscope is set to 500 mV per division. The only difference

between the three captures is the distance from the sensor to the disk: $\sim 1/8''$ in the first capture, $\sim 1/4''$ in the second capture, and $\sim 3/8''$ in the third capture.

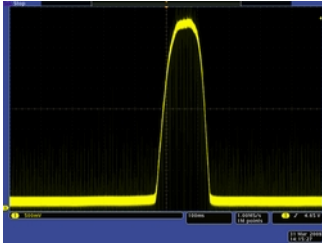

QTR-1A output $1/8''$ away from a spinning white disk with a black line on it.

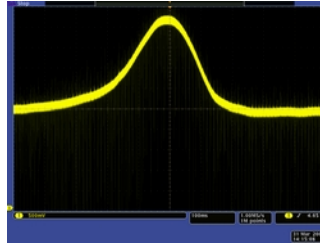

QTR-1A output $1/4''$ away from a spinning white disk with a black line on it.

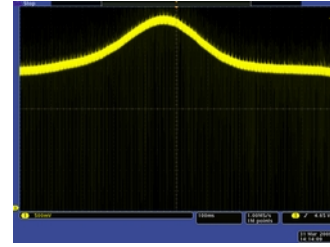

QTR-1A output $3/8''$ away from a spinning white disk with a black line on it.

As the distance between the sensor and the surface increases, the overall reflectance decreases and the total range of the sensor output decreases. At a distance of $1/8''$, the difference between the white surface and the black surface is around 4.5 V. At a distance of $3/8''$, the difference between the white surface and the black surface has decreased to around 1.2 V, which makes distinguishing between the two surfaces much harder and much more prone to error caused by noise or changes in lighting conditions.

Note that in these captures you can clearly see the effect of the motor's noise on the output signal. This underscores the importance of filtering your sensor output if it will be in a potentially noisy environment, either by using a low-pass filter circuit or by averaging several sensor readings together.