

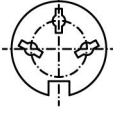





ARRANGEMENT OF CONTACTS

PARTS	3P	4P	5P		6P	7P	8P		
ANGLE	180°	216°	180°	240°	360°	240°	270°	270°	262°
POSITION OF VIEWS									

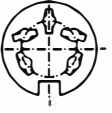
SPECIFICATIONS

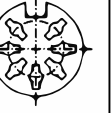
Contact resistance	20mΩ Max.
Dielectric strength	1,000V AC/1 Minute
Insulation resistance	100MΩ Min. at 500V DC
Rating	100V AC 2A

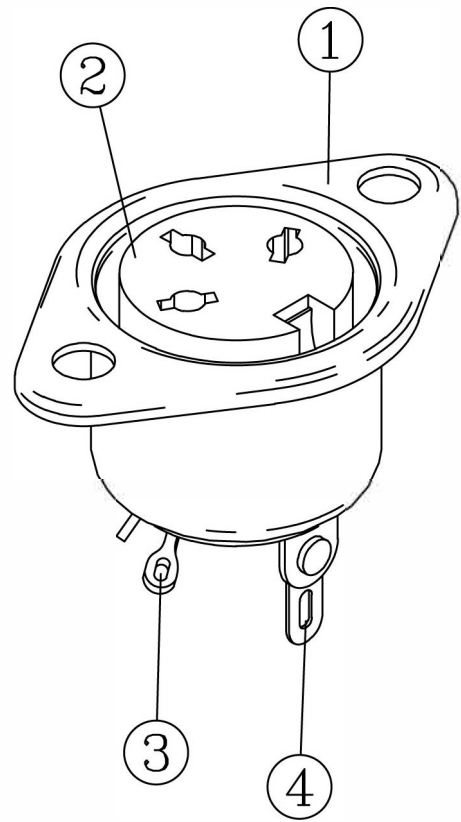
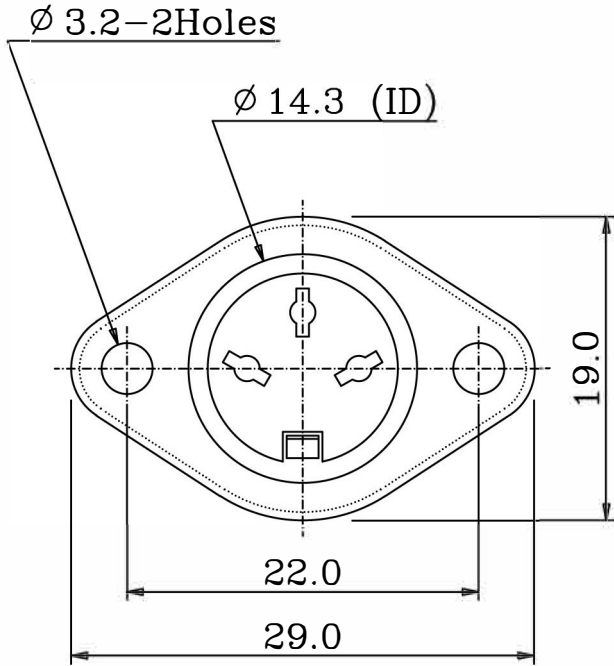

4	GROUNDING PIECE	1	BSR-H (0.2t) [C1519R-H]	NICKEL	30-50u"
3	CONTACT TERMINAL	3	BSR-H (0.6t) [C2680R]	TIN PLATED	30-50u"
2	FEMALE INSERT	1	PBT [D202G15]		UL94V-0
1	MAIN BODY	1	JIS G3141 SPCC-SD (0.4t)	NICKEL	30-50u"
P/N	PART NAME	Q'TY	MATERIAL	PLATING	REMARKS
DATE	SCALE	UNIT	MODEL NO.		
980917	2 : 1	M / M			
CONNECTORS					180° JACK
FILE NO. HSP-BF-B2001-3P					
DESIGN	DRAFTSMAN	APPROVE			
H. S. P.	C. C. U.	T. S. L.			