

Distributed by:



www.Jameco.com ♦ 1-800-831-4242

The content and copyrights of the attached material are the property of its owner.

Jameco Part Number 224223



PRODUCT SPECIFICATION

.093 SERIES PLUG AND RECEPTACLE POWER CONNECTORS

1.0 SCOPE

This Product Specification covers the 5.03 mm (.198 inch) centerline connector series using pin and socket terminals terminated with 14 to 24 AWG wire using crimp technology with tin plating.

2.0 PRODUCT DESCRIPTION

2.1 PRODUCT NAME AND SERIES NUMBER(S)

<u>PRODUCT NAME</u>	<u>SERIES NUMBER</u>
Plug Housing, 1-circuit	1619-1P
Receptacle Housing, 1-circuit	1619-1R
Plug Housing, 2-circuit	1545-P*
Receptacle Housing, 2-circuit	1545-R*
Plug Housing, 3-circuit	1396-P*
Receptacle Housing, 3-circuit	1396-R*
Plug Housing, 4-circuit (in-line)	1490-P*
Receptacle Housing, 4-circuit (in-line)	1490-R*
Plug Housing, 4-circuit (2 x 2)	2163-P*
Receptacle Housing, 4-circuit (2 x 2)	2163-R*
Plug Housing, 5-circuit	1653-P*
Receptacle Housing, 5-circuit	1653-R*
Plug Housing, 6-circuit	1261-P*
Receptacle Housing, 6-circuit	1261-R*
Plug Housing, 9-circuit	1292-P*
Receptacle Housing, 9-circuit	1292-R*
Plug Housing, 12-circuit	1360-P*
Receptacle Housing, 12-circuit	1360-R*
Socket Terminal, 14-18 AWG	1189
Pin Terminal, 14-18 AWG	1190
Socket Terminal, 18-22 AWG	1380
Pin Terminal, 18-22 AWG	1381
Socket Terminal, 22-24 AWG	2870
Pin Terminal, 22-24 AWG	2871
Socket Terminal, 14-18 AWG, (P-B)	4550
Socket Terminal, 18-22 AWG, (P-B)	2151

2.2 DIMENSIONS, MATERIALS, PLATINGS AND MARKINGS

Housings are molded of UL 94V-2 rated PA66.

Terminals are tin-plated brass or phosphor-bronze.

See appropriate sales drawings for additional information on dimensions, materials, platings and markings.

<u>REVISION:</u> B	<u>ECR/ECN INFORMATION:</u> EC No: UCR#2003-0230 DATE: 2002 / 08 / 07	<u>TITLE:</u> PRODUCT SPECIFICATION STANDARD .093 SERIES PLUGS & RECEPTACLES	<u>SHEET No.</u> 1 of 3
<u>DOCUMENT NUMBER:</u> PS-43660-9999	<u>CREATED / REVISED BY:</u> BWIRKUS 10/4/01	<u>CHECKED BY:</u> BWIRKUS 10/4/01	<u>APPROVED BY:</u> SFRY 10/5/01



PRODUCT SPECIFICATION

2.3 SAFETY AGENCY APPROVALS

UL File #E29179
CSA File #E29179

3.0 APPLICABLE DOCUMENTS AND SPECIFICATIONS

See the appropriate sales drawings for necessary referenced documents and specifications.

4.0 RATINGS

4.1 VOLTAGE

250 Volts AC (RMS)

4.2 CURRENT AND APPLICABLE WIRES

AWG	Circuit Size	Amps
14	3	14
14	9	11
18	3	10
18	9	7
22	3	7
22	9	5

4.3 TEMPERATURE

Operating: - 55°C to + 105°C

5.0 PERFORMANCE

5.1 ELECTRICAL REQUIREMENTS

ITEM	DESCRIPTION	TEST CONDITION	REQUIREMENT
1	Contact Resistance (Low Level)	Mate connectors: apply a maximum voltage of 20 mV and a current of 20 mA. (Measurement locations in Section 7.0)	10 milliohms MAXIMUM [initial]
2	Dielectric Withstanding Voltage	Mate connectors: apply a voltage of 2000 VAC for 1 minute between adjacent terminals and between terminals to ground.	No breakdown; current leakage < 500 mA
3	Temperature Rise (via Current Cycling)	Mate connectors, measuring the temperature rise at 60 minute intervals during 96 hours of steady state at rated current; followed by 240 hours of current cycling (45 minutes ON and 15 minutes OFF per hour) with measurements made during last 5 minute period of each ON cycle; followed by 96 hours of steady state at rated current with measurements taken at 60 minute intervals.	Temperature rise: +30°C MAXIMUM

REVISION: B	ECR/ECN INFORMATION: EC No: UCR#2003-0230 DATE: 2002 / 08 / 07	TITLE: PRODUCT SPECIFICATION STANDARD .093 SERIES PLUGS & RECEPTACLES	SHEET No. 2 of 3
DOCUMENT NUMBER: PS-43660-9999	CREATED / REVISED BY: BWIRKUS 10/4/01	CHECKED BY: BWIRKUS 10/4/01	APPROVED BY: SFRY 10/5/01



PRODUCT SPECIFICATION

5.2 MECHANICAL REQUIREMENTS

ITEM	DESCRIPTION	TEST CONDITION	REQUIREMENT
4	Connector Mate and Unmate Forces	Mate and unmate connector (male to female) at a rate of 25 ± 6 mm ($1 \pm \frac{1}{4}$ inch) per minute for a total of 25 cycles. Initial mate forces to be measured. Unmate forces to be measured after 25 cycles.	15.6 N (3.5 lbf) MAXIMUM insertion force 4.4 N (1 lbf) MINIMUM withdrawal force
5	Terminal Retention Force (in Housing)	Axial pullout force on the terminal in the housing at a rate of 25 ± 6 mm ($1 \pm \frac{1}{4}$ inch) per minute.	89 N (20 lbf) MINIMUM retention force
6	Wire Pullout Force (Axial)	Apply an axial pullout force on the wire at a rate of 25 ± 6 mm ($1 \pm \frac{1}{4}$ inch).	MINIMUM pullout forces: 14 AWG 178 N (40 lbf) 16 AWG 156 N (35 lbf) 18 AWG 133 N (30 lbf) 20 AWG 89 N (20 lbf) 22 AWG 62 N (14 lbf) 24 AWG 36 N (8 lbf)
7	Terminal Insertion Force (into Housing)	Apply an axial insertion force on the terminal at a rate of 25 ± 6 mm ($1 \pm \frac{1}{4}$ inch).	22N (5 lbf) MAXIMUM insertion force

5.3 ENVIRONMENTAL REQUIREMENTS

ITEM	DESCRIPTION	TEST CONDITION	REQUIREMENT
8	Thermal Cycling	Mate connectors; expose to temperature cycling between -25°C and 70°C for 500 cycles with a dwell time of 30 minutes at each extreme. Measurements to be taken initially and after every 100 cycles.	10 milliohms MAXIMUM (change from initial) & Visual: No Damage

6.0 PACKAGING

Parts shall be packaged to protect against damage during handling, transit and storage. See the appropriate sales drawings for additional information on packaging requirements.

REVISION: B	ECR/ECN INFORMATION: EC No: UCR#2003-0230 DATE: 2002 / 08 / 07	TITLE: PRODUCT SPECIFICATION STANDARD .093 SERIES PLUGS & RECEPTACLES	SHEET No. 3 of 3
DOCUMENT NUMBER: PS-43660-9999	CREATED / REVISED BY: BWIRKUS 10/4/01	CHECKED BY: BWIRKUS 10/4/01	APPROVED BY: SFRY 10/5/01

PART NO.	ENG. NO.
02-09-2103	1190-(P901)L
02-09-2101	1190-(P901)
02-09-6110	1190-(591)L
02-09-6101	1190-(591)
02-09-6106	1190-(550)L
02-09-6100	1190-(550)

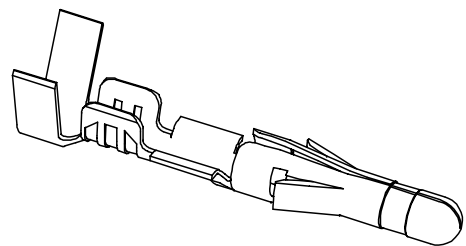
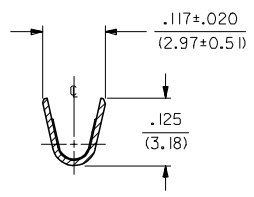
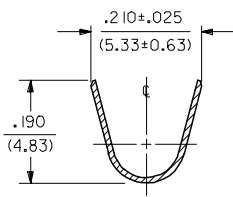
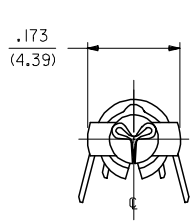

SECT. "A-A"

SECT. "B-B"

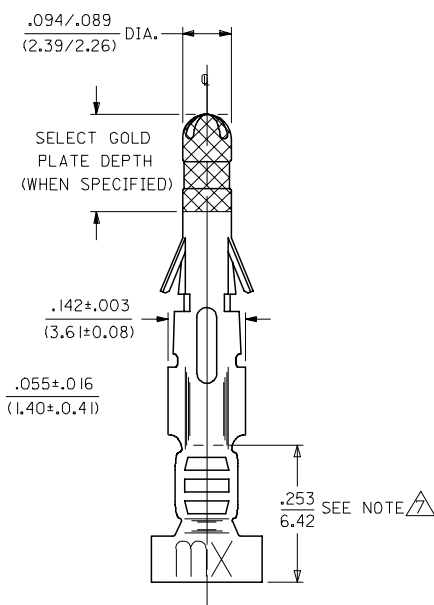
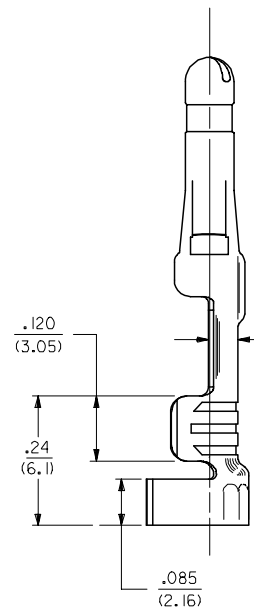
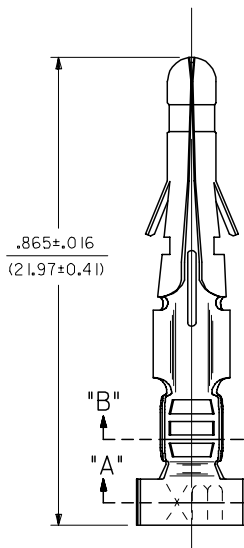

NOTES:

- MATERIAL:
CARTRIDGE BRASS
- FINISH CODES:
901 HOT TIN DIP .000020/(0.00051) MIN.
591 SELECT GOLD PLATE .000050/(0.00127) MIN. IN CONTACT AREA,
OVER .000050/(0.00127) MIN. NICKEL OVERALL
WITH .000010/(0.00025) MAX. GOLD FLASH OVERALL.
550 SELECT GOLD PLATE .000015/(0.00038) MIN. IN CONTACT AREA,
OVER .000030/(0.00076) MIN. NICKEL OVERALL
WITH .000010/(0.00025) MAX. GOLD FLASH OVERALL.
- PRODUCT SPECIFICATION: PS-43660-9999
- TERMINAL FOR USE WITH .093/(2.36) SERIES HOUSINGS AND WILL
ACCEPT 14 THRU 20 AWG WIRE.
- INSERTION FORCE: 3.5 LBS. MAX. WHEN TERMINAL IS INSERTED
INTO .093 SERIES HOUSING.
- RETENTION: 20 LBS. MIN. FROM HOUSING.

△ DIMENSION FROM THE END OF THE TERMINAL TO THE END OF THE BRUSH
ON THE WIRE CRIMPED INTO THE TERMINAL.

LEGEND

1190-(****)*

- FORM: BLANK=CHAIN, L=LOOSE
- FINISH CODE: P=PREPLATE, BLANK=POSTPLATE

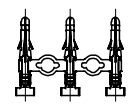

CHAIN FORM
FULL SCALE

LEAD FREE UPDATE EC NO: UCP2005-2754 DRWN: JONE 2005/06/24 CHKD: ADERR 2005/06/24 APPR: FSM TH 2005/06/24 REV: BS	QUALITY SYMBOLS	GENERAL TOLERANCES (UNLESS SPECIFIED)	DIMENSION STYLE	SCALE	DESIGN UNITS	THIRD ANGLE PROJECTION
	$\nabla=0$ $\nabla=0$	mm INCH 4 PLACES ± --- ± --- 3 PLACES ± --- ± .010 2 PLACES ± 0.25 ± .014 1 PLACE ± 0.13 ± --- ANGULAR ±1/2°	IN/MM DRAWN BY: GEP DATE: 10/26/87 CHECKED BY: RW DATE: 10/26/87 APPROVED BY: RAS DATE: 10/26/87	6:1	INCH	
	DRAFT WHERE APPLICABLE MUST REMAIN WITHIN DIMENSIONS	SEE CHART MATERIAL NO. DOCUMENT NO.	TITLE CRIMP TERMINAL, MALE .093/(2.36) DIA. FOR 14 THRU 20 AWG. WIRE MOLEX MOLEX INCORPORATED	SHEET NO. 1 OF 1		
	SIZE 	THIS DRAWING CONTAINS INFORMATION THAT IS PROPRIETARY TO MOLEX INCORPORATED AND SHOULD NOT BE USED WITHOUT WRITTEN PERMISSION	SD-1190-*			