



■ Features

- Ultra slim design with 70mm(4SU) width
- Universal input 85~264VAC(277VAC operational)
- No load power consumption<0.3W
- Isolation class II
- Pass LPS (Limited power source) for Blank type
- DC output voltage adjustable
- Protections : Short circuit / Overload / Over voltage
- Cooling by free air convection (working temperature:-30~+70°C)
- DIN rail TS-35/7.5 or 15 mountable
- Over voltage category III
- LED indicator for power on
- 3 years warranty

■ Applications

- Household control system
- Building automation
- Industrial control system
- Factory automation
- Electro-mechanical apparatus

■ Description

HDR-100 is one economical ultra slim 100W DIN rail power supply series, adapt to be installed on TS-35/7.5 or TS-35/15 mounting rails. The body is designed 70mm(4SU) in width, which allows space saving inside the cabinets. The entire series adopts the full range AC input from 85VAC to 264VAC(277VAC operational) and conforms to EN61000-3-2, the norm the European Union regulates for harmonic current. HDR-100 is designed with plastic housing that it can effectively prevent user from electric hazards. With working efficiency up to 90%, the entire series can operate at the ambient temperature between -30°C and 70°C under air convection. The complete protection functions and relevant certificates for home automations and industrial control apparatus (IEC60950-1,UL508, UL60950-1, EN61558-2-16) make HDR-100 a very competitive power supply solution for household and industrial applications.

■ Model Encoding

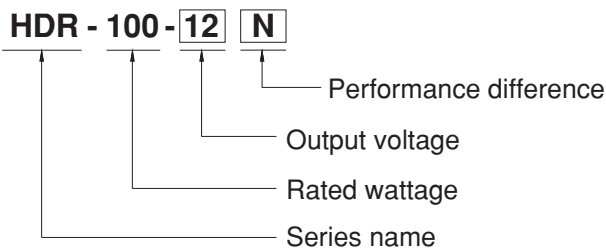

Type	Description	Note
Blank	92W max, Pass LPS with a narrower output adjustable range	In stock
N	100W max, Non-LPS with a wider output adjustable range	In stock



SPECIFICATION

MODEL		HDR-100-12	HDR-100-12N	HDR-100-15	HDR-100-15N	HDR-100-24	HDR-100-24N	HDR-100-48	HDR-100-48N	
OUTPUT	DC VOLTAGE	12V		15V		24V		48V		
	RATED CURRENT	7.1A	7.5A	6.13A	6.5A	3.83A	4.2A	1.92A	2.1A	
	CURRENT RANGE	0 ~ 7.1A	0 ~ 7.5A	0 ~ 6.13A	0 ~ 6.5A	0 ~ 3.83A	0 ~ 4.2A	0 ~ 1.92A	0 ~ 2.1A	
	RATED POWER	85.2W	90W	92W	97.5W	92W	100.8W	92.2W	100.8W	
	RIPPLE & NOISE (max.) Note.2	120mVp-p		120mVp-p		150mVp-p		240mVp-p		
	VOLTAGE ADJ. RANGE	Pass LPS	12 ~ 13V		15 ~ 17V		24 ~ 25.5V		48 ~ 48.7V	
		Non LPS	12 ~ 13.8V		13.5 ~ 18V		21.6 ~ 29V		43.2 ~ 55.2V	
	VOLTAGE TOLERANCE Note.3	± 2.0%		± 1.0%		± 1.0%		± 1.0%		
	LINE REGULATION	± 1.0%		± 1.0%		± 1.0%		± 1.0%		
	LOAD REGULATION	± 1.0%		± 1.0%		± 1.0%		± 1.0%		
SETUP, RISE TIME	500ms, 60ms/230VAC		500ms, 60ms/115VAC at full load							
HOLD UP TIME (Typ.)	30ms/230VAC		12ms/115VAC at full load							
INPUT	VOLTAGE RANGE	85 ~ 264VAC (277VAC operational)			120 ~ 370VDC (390VDC operational)					
	FREQUENCY RANGE	47 ~ 63Hz								
	EFFICIENCY (Typ.)	88%		89%		90%		90%		
	AC CURRENT (Typ.)	3A/115VAC		1.6A/230VAC						
	INRUSH CURRENT (Typ.)	COLD START 35A/115VAC		70A/230VAC						
PROTECTION	OVERLOAD	HDR-100 : 102 ~ 110% rated output power ; HDR-100-xxN : 105 ~ 150% rated output power Hiccup mode when output voltage <50%, recovers automatically after fault condition is removed Constant current limiting within 50% ~ 100% rated output voltage, recovers automatically after fault condition is removed								
	OVER VOLTAGE	14.2 ~ 16.2V		18.8 ~ 22.5V		30 ~ 36V		56.5 ~ 64.8V		
		Protection type : Shut down o/p voltage, re-power on to recover								
ENVIRONMENT	WORKING TEMP.	-30 ~ +70°C (Refer to "Derating Curve")								
	WORKING HUMIDITY	20 ~ 90% RH non-condensing								
	STORAGE TEMP., HUMIDITY	-40 ~ +85°C, 10 ~ 95% RH non-condensing								
	TEMP. COEFFICIENT	± 0.03%/°C (0 ~ 50°C) RH non-condensing								
	VIBRATION	10 ~ 500Hz, 2G 10min./1cycle, period for 60min. each along X, Y, Z axes; Mounting: Compliance to IEC60068-2-6								
	OPERATING ALTITUDE	2000 meters								
	OVER VOLTAGE CATEGORY	III ; According to EN61558, EN50178, EN60664-1, EN62477-1 ; altitude up to 2000 meters								
SAFETY & EMC (Note 5)	SAFETY STANDARDS	UL60950-1, UL508, TUV EN61558-2-16, IEC60950-1, EAC TP TC 004, BSMI CNS14336-1 approved; Design refer to TUV EN60950-1								
	WITHSTAND VOLTAGE	I/P-O/P:4KVAC								
	ISOLATION RESISTANCE	I/P-O/P:100M Ohms / 500VDC / 25°C / 70% RH								
	EMC EMISSION	Parameter	Standard				Test Level / Note			
		Conducted	EN55032(CISPR32), CNS13438				Class B			
		Radiated	EN55032(CISPR32), CNS13438				Class B			
		Harmonic Current (Note 5)	EN61000-3-2				Class A			
		Voltage Flicker	EN61000-3-3				-----			
	EMC IMMUNITY	EN55024, EN61000-6-2, EN61204-3								
		Parameter	Standard				Test Level / Note			
ESD		EN61000-4-2				Level 3, 8KV air; Level 2, 4KV contact, criteria A				
Radiated Susceptibility		EN61000-4-3				Level 3, criteria A				
EFT/Burest		EN61000-4-4				Level 3, criteria A				
Surge		EN61000-4-5				Level 4, 2KV/L-N, criteria A				
Conducted		EN61000-4-6				Level 3, criteria A				
Magnetic Field		EN61000-4-8				Level 4, criteria A				
Voltage Dips and interruptions	EN61000-4-11				>95% dip 0. 5 periods, 30% dip 25 periods, >95% interruptions 250 periods					
OTHERS	MTBF	856.5K hrs min. MIL-HDBK-217F (25°C)								
	DIMENSION	70*90*54.5mm (W*H*D)								
	PACKING	0.27Kg; 48pcs/14Kg/1.06CUFT								
NOTE	<p>1. All parameters NOT specially mentioned are measured at 230VAC input, rated load and 25°C of ambient temperature.</p> <p>2. Ripple & noise are measured at 20MHz of bandwidth by using a 12" twisted pair-wire terminated with a 0.1µf & 47µf parallel capacitor.</p> <p>3. Tolerance : includes set up tolerance, line regulation and load regulation.</p> <p>4. Harmonic current test at 90% load for HDR-100-xxN.</p> <p>5. The power supply is considered as an independent unit, but the final equipment still need to re-confirm that the whole system complies with the EMC directives. For guidance on how to perform these EMC tests, please refer to "EMI testing of component power supplies." (as available on http://www.meanwell.com)</p> <p>6. The ambient temperature derating of 3.5°C/1000m with fanless models and of 5°C/1000m with fan models for operating altitude higher than 2000m(6500ft).</p>									

■ Block Diagram

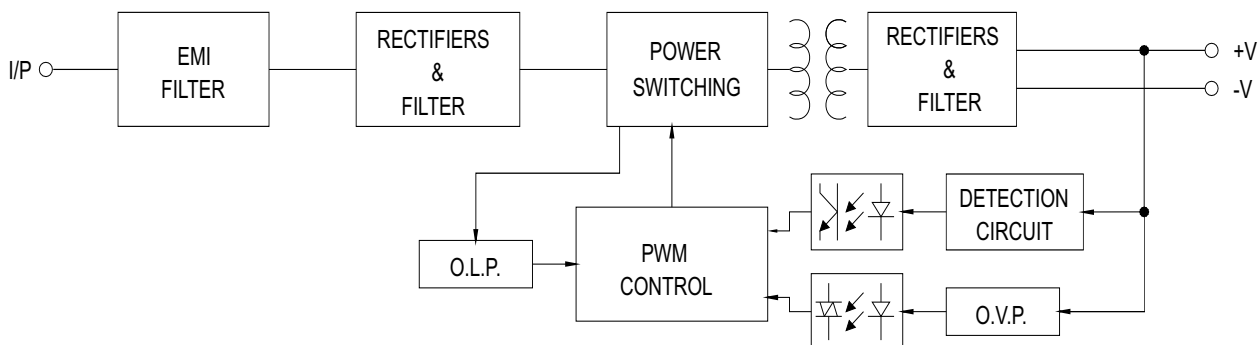

■ Derating Curve VS Ambient Temperature

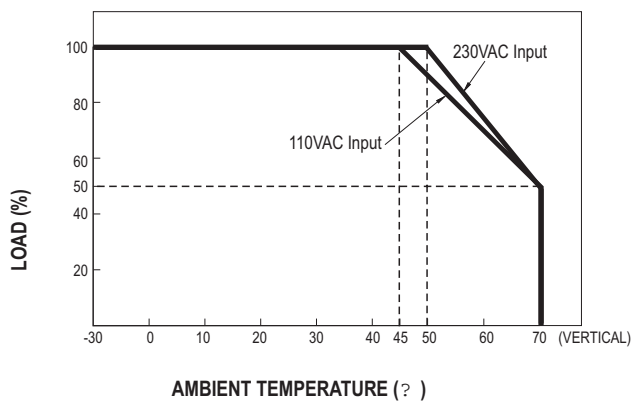

■ Output Derating VS Input Voltage

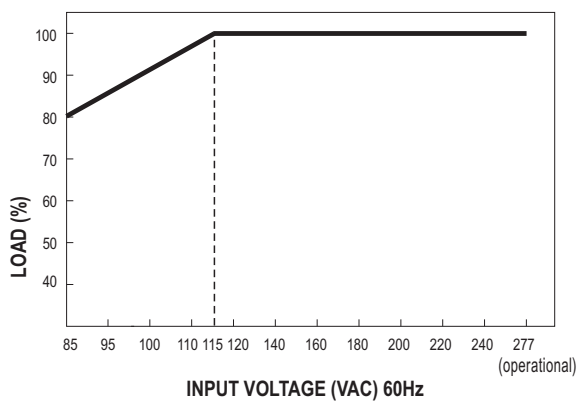

Mechanical Specification

(Unit: mm , tolerance $\pm 0.5\text{mm}$)

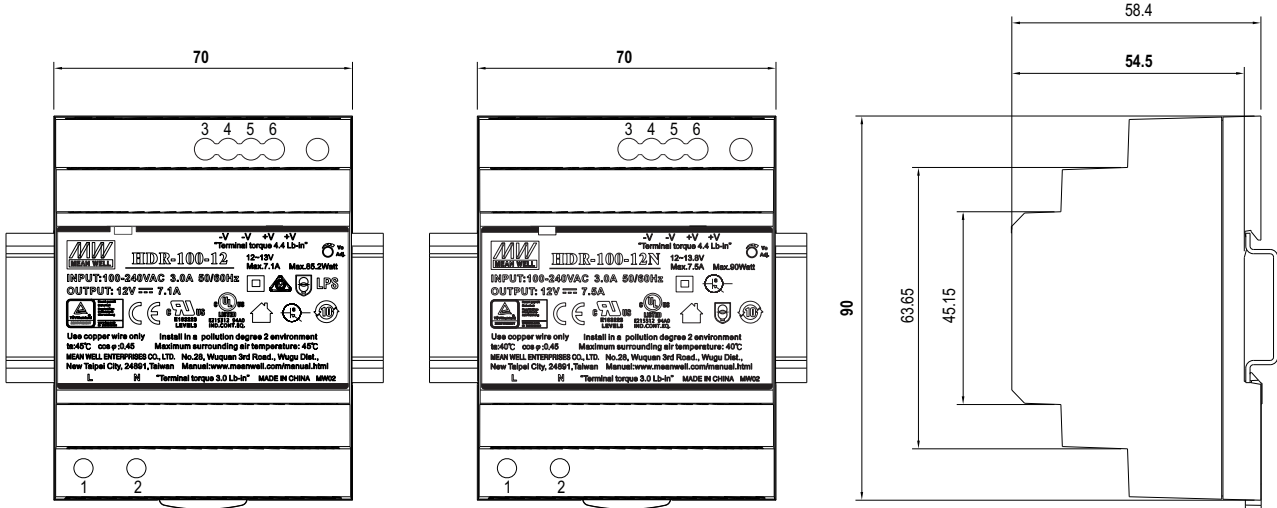

ADMISSIBLE DIN-RAIL: TS35/7.5 OR TS35/15

Terminal Pin No. Assignment

Pin No.	Assignment	Pin No.	Assignment
1	AC/L	3,4	-V
2	AC/N	5,6	+V

Installation Manual

Please refer to : <http://www.meanwell.com/manual.html>