

CUSTOMER

JAMES

SPECIFICATION FOR APPROVAL

AC/DC ADAPTOR

CUSTOMER SPEC:INPUT: 100-240V AC 50/60Hz OUTPUT:12VDC 5000mA

CUSTOMER DWG./PART NO. KPL-060F-VI,1185# 5.5*2.5*11mm,1200mm

PART NO. G99-KPL060F-L253

SAMPLE NO: _____ REV.: _____ ISSUE DATE: 2018-8-13

PRDUCT NO: _____

Unit Color: Black



White



APPROVED SIGNATURES/客户确认		
核准/APPROVED BY	审核/ CHECKED BY:	检测/TESTED BY:

Manufacturer/制造商			
业务/SALES	品管/QE	核准/APPROVED BY	制样/DESIGNED BY
EDDY 袁	周松平	宋军	阳灿

Von Development Ltd. 旺怡發展有限公司

1A, Fook Ying Bldg, 379 Kings Road, North Point, Hong Kong

TEL: 852-2187-2875

FAX: 852-3012-1881

info@vonhk.com

Table of Contents

1	SCOPE	5
2	ELECTRICAL SPECIFICATION	5
2.1	INPUT REQUIREMENT	5
2.1.1	<i>Input voltage range</i>	5
2.1.2	<i>Input frequency range</i>	5
2.1.3	<i>AC inrush current</i>	5
2.1.4	<i>Input current</i>	5
2.1.5	<i>Leakage current</i>	6
2.1.6	<i>Insulation resistance</i>	6
2.1.7	<i>Low power consumption</i>	6
2.2	INPUT PROTECTION	6
2.2.1	<i>Input current protection</i>	6
2.3	OUTPUT REQUIREMENT	6
2.3.1	<i>Output power</i>	6
2.3.2	<i>Output voltage and current</i>	6
2.3.3	<i>Ripple and noise</i>	7
2.3.4	<i>Over voltage protection</i>	7
2.3.5	<i>Over current protection</i>	7
2.3.6	<i>Overshoot</i>	7
2.3.7	<i>Short circuit Protection</i>	7
2.3.8	<i>Audible noise</i>	8
2.4	PERFORMANCE REQUIREMENT	8
2.4.1	<i>Efficiency</i>	8
2.4.2	<i>Turn on delay time</i>	8
2.4.3	<i>Hold-up time</i>	8
2.4.4	<i>Dynamic load</i>	8
3	ENVIRONMENTAL SPECIFICATION	8
3.1	TEMPERATURE	8
3.2	HUMIDITY	9
3.3	VIBRATION AND SHOCK	9
3.4	ALTITUDE.....	9

ISSUE DATE: 2014/09/20	Revision No.: 1.0	
Specification No:	Page: 3 of 11	

	MODEL NO : KPL060F-VI 12.0V/5.0A ENGINEERING SPECIFICATION SHEET
--	--

3.5	CALCULATED MEAN TIME BETWEEN FAILURES (MTBF)	9
3.6	BURN-IN	9
4	RELATED SPECIFICATION	10
4.1.1	<i>EMI</i>	10
4.1.2	<i>Dielectric strength—(Hi-pot)</i>	10
4.1.3	<i>Surge</i>	10
4.1.4	<i>Electrostatic discharge ESD</i>	10
4.1.5	<i>RF Immunity</i>	10
4.1.6	<i>Environment standards</i>	11
4.1.7	<i>E lectrical Fast Transients (EFT)</i>	11
5	MECHANICAL	11
5.1	INPUT CONNECTOR AND OUTPUT CABLE	11
5.1.1	<i>Input connector</i>	11
5.1.2	<i>Output cable</i>	11
5.2	AC ADAPTER EXTERNAL DIMENSION	11

ISSUE DATE: 2014/09/20	Revision No.: 1.0	
Specification No:	Page: 4 of 11	

1 SCOPE

This document describes basic electrical characteristics and mechanical characteristic of 60 W power adapters.

2 ELECTRICAL SPECIFICATION

2.1 INPUT REQUIREMENT

2.1.1 INPUT VOLTAGE RANGE

Industrial power supply shall operate within input specification from 90Vac to 264Vac or provide automatic switching between high line and low line input ranges. The table below shows common input voltage range.

Input Range	Minimum	Nominal	Maximum	Unit
	90 V	100V- 240V	264V	Vac Rms

Table 1 - Input Voltage Range

2.1.2 INPUT FREQUENCY RANGE

The industrial power supply shall operate within specification from 47 to 63 Hz.

2.1.3 AC INRUSH CURRENT

Peak inrush current should not exceed 100 A at 240Vac, 50Hz, 25 degrees C, cold start. It should not interrupt line fuse or cause damage to the industrial power supply either at cold or warm start.

Peak inrush current should not exceed 60 A at 100Vac, 60Hz, 25 degrees C, cold start. It should not interrupt line fuse or cause damage to the industrial power supply either at cold or warm start.

The inrush current must be limited to the extent that no damage is done to the supply under any specified line, load, and temperature conditions. The inrush current shall not cause any external protection devices (i.e. fuses) to trip.

2.1.4 INPUT CURRENT

Maximum steady state input current shall not exceed 1.7 A for any line voltage specified in 2.1.1.

ISSUE DATE: 2014/09/20	Revision No.: 1.0	
Specification No:	Page: 5 of 11	

**MODEL NO : KPL060F-VI 12.0V/5.0A
ENGINEERING SPECIFICATION SHEET**

2.1.5 LEAKAGE CURRENT

0.75mA maximum at 240Vac 50Hz

2.1.6 INSULATION RESISTANCE

Insulation resistance shall be more than 50M ohm between primary and secondary.

2.1.7 LOW POWER CONSUMPTION

Vin	Load	Power consumption
240Vac/50Hz 100Vac/60Hz	0A	≤ 0.15 W

2.2 INPUT PROTECTION

2.2.1 INPUT CURRENT PROTECTION

A fuse with rating of 3.15 A / 250 V (Time Lag type) shall be installed on the input line side near the input connector and no any electrical components before.

2.3 OUTPUT REQUIREMENT

2.3.1 OUTPUT POWER

The total output power, under steady state conditions, shall not exceed 60 W.

2.3.2 OUTPUT VOLTAGE AND CURRENT

Under any combination of line and load variation and environmental conditions, all outputs shall remain within tolerance as defined in Table 2. Output voltage(s) shall be measured at the load side of output connector.

Output Voltage	Voltage Range		Current Range		
	Lower Limit	Upper Limit	Minimum Load	Full rated load	PK Load
+12.0V	11.40V	12.60V	0.0A	5.0A	--

Table 2 - Output Voltage and Current

ISSUE DATE: 2014/09/20	Revision No.: 1.0	
Specification No:	Page: 6 of 11	

MODEL NO : KPL060F-VI 12.0V/5.0A ENGINEERING SPECIFICATION SHEET
--

2.3.3 RIPPLE AND NOISE

Measurements shall be made with an oscilloscope with minimum of 20MHz bandwidth and 1:1 scope Probe, Output shall be bypassed at the connector with a 0.1µF ceramic disk capacitor and a 47µF electrolytic capacitor for general testing purpose.

Output Voltage	Maximum Ripple & Noise (Vp-p)
+12.0V	240mV

Table 3 – Ripple and Noise

2.3.4 OVER VOLTAGE PROTECTION

The power supply shall provide with over voltage protection such that under any single component failure.

The power supply provides output over voltage protected in latch off by zener diode, and no damage to customer device.

2.3.5 OVER CURRENT PROTECTION

The power supply shall be protected when operating any output in overload condition. The power supply shall be shut down and no any damage when the over current condition occurs on the output, and It will be auto-recovered when the failure is removed.

Output Voltage	Over current protection		Test condition
	Lower Limit	Upper Limit	
+12.0V	5.80A	9.00A	Input voltage:100Vac 60Hz or 240Vac 50Hz.

Table 4 –Over current protection

2.3.6 OVERSHOOT

During turn on or turn off, the output overshoot shall not exceed nominal output voltage by more than 5%, and output shall not change its polarity with respect to its return line.

2.3.7 SHORT CIRCUIT POTECTION

Power supply shall have self-limiting protection to protect against short circuit or overload conditions. No damage to the power supply shall result from a continuous or intermittent short circuit condition. It will be auto-recovered when the failure is removed.

ISSUE DATE: 2014/09/20	Revision No.: 1.0	
Specification No:	Page: 7 of 11	

	MODEL NO : KPL060F-VI 12.0V/5.0A ENGINEERING SPECIFICATION SHEET
--	---

2.3.8 AUDIBLE NOISE

There is no audible noise canned been heard when it work with rated spec.

2.4 PERFORMANCE REQUIREMENT

2.4.1 EFFICIENCY

Active average mode Efficiency (watt out / watt in) shall be a minimum of 89.00 % at 230vac/50Hz.

Active average mode Efficiency (watt out / watt in) shall be a minimum of 88.00 % at 115vac/60Hz.

Complies to EPA DOE standard specification and EU CEC standard specification (Level VI).

calculate the model is single average active mode efficiency for each test voltage by testing at 100%,75%,50%,and 25% of rated current output and then computing the simple arithmetic average of these four values respectively at 115V/60HZ and 230V/50HZ test result for reference.

Efficiency (watt out / watt in) shall be a minimum of 79.00 % at 10% full load.

Note: when testing efficiency, adapter needs to electrify to perform after full load 60 minutes

Input voltage 115Vac 60Hz or 230Vac 50Hz

2.4.2 TURN ON DELAY TIME

Output shall reach steady state within 5 seconds of turn on at 100Vac or greater.

Output shall reach steady state within 2 seconds of turn on at 240Vac or greater.

2.4.3 HOLD-UP TIME

Hold-up time shall be a minimum of 8 mS at 100Vac / 60Hz input.

2.4.4 DYNAMIC LOAD

Power supply output voltage tolerance shall be complied with $\pm 5\%$.

Step load change: from 50% to100% Load on the output.

Dwell Time: 100Hz & 1 KHz 50% duty.

Slew rate: 0.5A/uses

3 ENVIRONMENTAL SPECIFICATION

3.1 TEMPERATURE

Operation within specification: -10 to 45 degrees C.

Storage: -20 to 85 degrees C

ISSUE DATE: 2014/09/20	Revision No.: 1.0	
Specification No:	Page: 8 of 11	

	MODEL NO : KPL060F-VI 12.0V/5.0A ENGINEERING SPECIFICATION SHEET
--	---

3.2 HUMIDITY

Operation: 10% to 90% relative humidity, non-condensation.

Storage: 5% to 95% relative humidity, including condensation.

3.3 VIBRATION AND SHOCK

The power supply shall be designed to withstand normal transportation vibration per MIL-STD-810F, method 514 and procedures X, as it is mounted in the chassis assembly and packed for shipping.

3.4 ALTITUDE

The power supply shall operate properly at any altitude between 0 ~ 16,404 feet (5000 meter) above sea level, and withstand storage at 50,000 feet.

3.5 CALCULATED MEAN TIME BETWEEN FAILURES (MTBF)

The MTBF for the power adapter shall equal or exceed 100,000 hours when operated at full rated load in an ambient temperature of 25 degree C.

3.6 BURN-IN

Burn-in test:

Test condition: 110Vac / 220Vac 50Hz, with 100% maximum load at 45 ±5°C ambient temperature.

Test method: burn-in 110 minutes; and 30 seconds "ON", 30 seconds "OFF" within 5 minutes, then 5 minutes "ON"

Test criteria: during this conditioning the power supply output normal and no damage or hazardous condition will occur.

ORT and life test:

Input condition: 110Vac / 220Vac 50Hz, "ON/OFF" 10 times within 5 minutes, 45 minutes "ON" 45 minutes "OFF",

Test condition: cycle by cycle test 168 hours with 100% maximum load at 45 ±5°C ambient temperature.

Test criteria: during this conditioning the power supply output normal and no damage or hazardous condition will occur.

ISSUE DATE: 2014/09/20	Revision No.: 1.0	
Specification No:	Page: 9 of 11	

4 RELATED SPECIFICATION

4.1.1 EMI

VCCI Class-B

FCC 15(Class-B, 115Vac operation)

CISPR 22 Class-B limits

EN55022 (1998+A1:2000+A2:2003 Class-B limits)

47 CFR Part 15, Subpart B, Class B limits

GB 9254 ITE Emissions Latest Edition

4.1.2 DIELECTRIC STRENGTH—(HI-POT)

Primary to secondary: **1500VAC.**

Test time: 60 second

Cut-off current: 5mA max

Arcing current: 10mA max

4.1.3 SURGE

It is referring to EN61000-4-5 IEC61000-4-5:2001 Level 4.

Differential mode surge immunity: 2KV

Common-mode Surge Immunity: 4KV

* **Determination level: Criteria A (Product testing and testing before and after any change in function is not).**

4.1.4 ELECTROSTATIC DISCHARGE ESD

It is referring to EN61000-4-2, IEC61000-4-2:2001, IEC801-2 Level 3.

Contact electrostatic discharge: + - 6KV.

Air electrostatic discharge: + - 8KV.

* **Determination level: Criteria A (Product testing and testing before and after any change in function is not).**

4.1.5 RF IMMUNITY

It is referring to IEC61000-4-3 Class A 3V/m

ISSUE DATE: 2014/09/20	Revision No.: 1.0	
Specification No:	Page: 10 of 11	

4.1.6 ENVIRONMENT STANDARDS

RoHS Regulation

The RoHS compliance symbol will be included on the data plate.

4.1.7 ELECTRICAL FAST TRANSIENTS (EFT)

It is referring to IEC61000-4-4 Class B Test Voltage: 2KV

5 MECHANICAL

5.1 INPUT CONNECTOR AND OUTPUT CABLE

5.1.1 INPUT CONNECTOR

AC Input connector shall be IEC320 C14 or C6 power connector.

5.1.2 OUTPUT CABLE

Please read the reference to FIG.

5.2 AC ADAPTER EXTERNAL DIMENSION

ISSUE DATE: 2014/09/20	Revision No.: 1.0	
Specification No:	Page: 11 of 11	

版本	修訂內容	修訂者	日期
0.1	新製	W.B.LIAO	2015.10.21

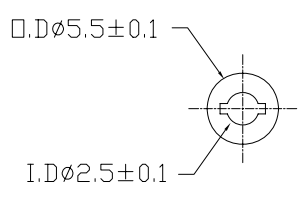
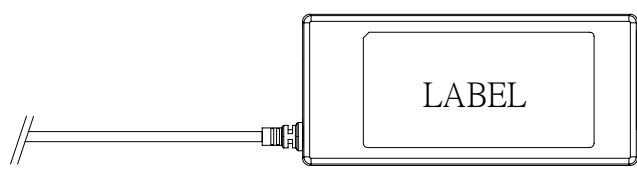
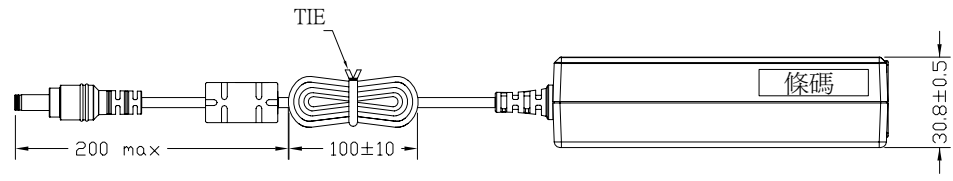
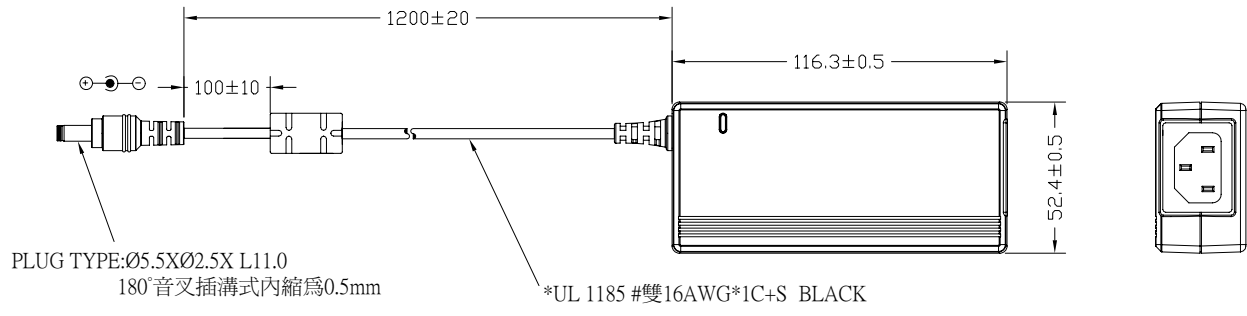

VIEW "A"
(SCALE 3:1)

NOTES:

1. CASE & CABLE COLOR : BLACK
2. CABLE SPEC.:CABLE ARE UL 1185 16AWG*1C+S BLACK
3. MODEL:G99-KPL060F-L030
4. PART NO.:G18-B3A212A-M800

APPROVED W.B.LIAO	DRAWING NO. KP-L-C14-116	UNIT INCHES(MM)	REV. A
DATE 2015.10.21	MODEL NO. KPL	TOLERANCES: .X = ±0.2 .XX = ±0.15	SHEET 1/1
TITLE Desktop Switching Adapter			

MODEL No.:

料號:G35-D

REV: A

工作要點

- 1.材質: 100#消銀龍+OPP(UL安規)(厚度0.12~0.15mm)
- 2.SIZE:79.5*39.5mm
- 3.顏色:銀底黑字.
- 4.印刷字體大小,位置,內容詳見drawing.
- 5.印刷必須清晰不得有斷線,模糊不清等不良現象.
- 6.背膠必須耐溫100°C,2H不會產生翹起,起泡等不良現象.
- 7.請參照RoHS and REACH環保標準生產.
- 8.UL必須符合PGDQ2.
- 9.最小包裝上必須有廠商名稱或LOGO,產品名稱,產品型號,規格,UL Mark以及UL Number.

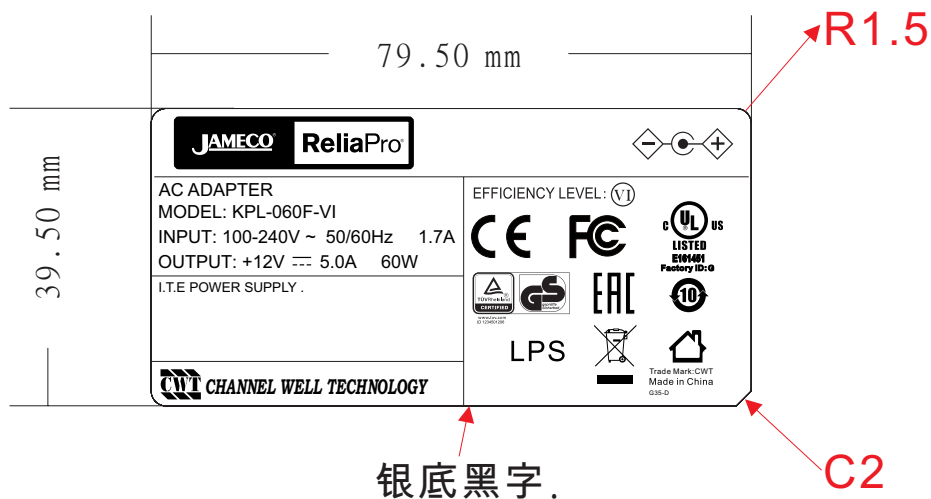

ISSUE BY:

王艷麗

CHECK BY:

宋書軍

APPROVED:

宋書軍

STEP1:將成品及線材整理好裝入PE袋,如下圖,

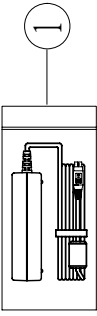

STEP2:將成品放入白盒內,如下圖:

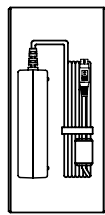

STEP3:將裝好成品的白盒放入紙箱內,如下圖:

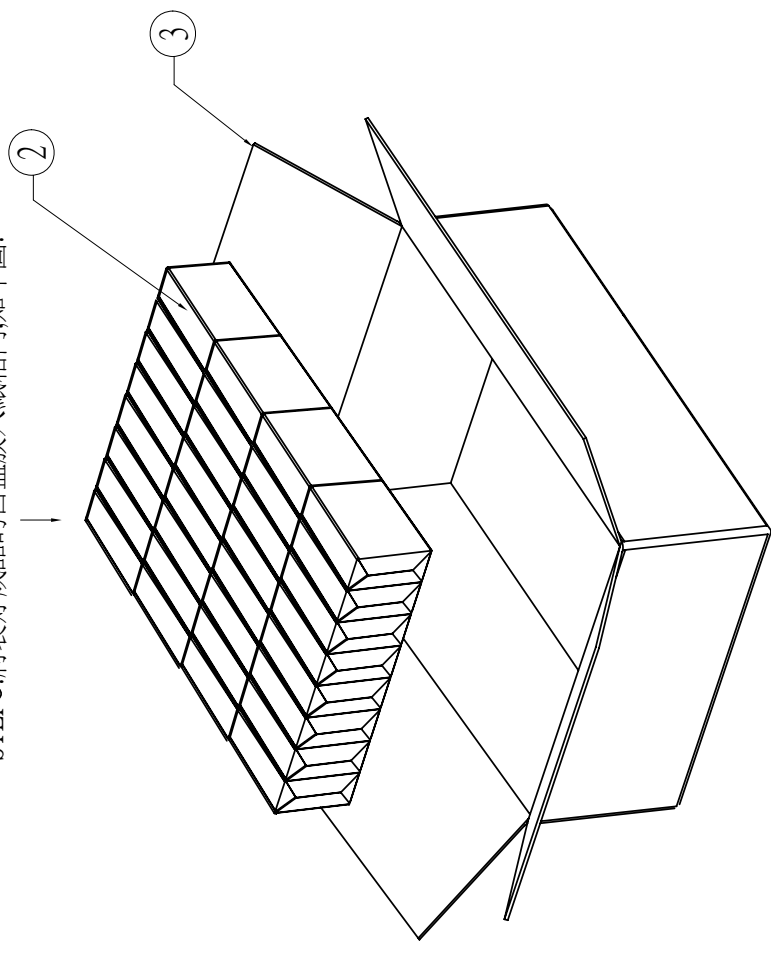

- 1.組件:
 1.1.:PE袋:220*180mm,T=0.04mm
 料號:G25-B220005-P100
 用量:32PCS
 1.2.:白盒:40*100*40mm,350g+CE
 料號:G24-F141021-PD00
 用量:32PCS
 1.3.:料號:G24-A583512-PD00
 用量:1PCS
 外箱尺寸: 585*350*116mm
 QTY.: 32 PCS
 N.W.: KGS
 G.W.: KGS
 MEAS.: 0.84 CUFT

環保材料標準:

No	有害物質名稱	含量標準	SHEET METAL TOLERANCE (UNLESS OTHERWISE SPECIFIED)			
			DIMENSION	PIERCING	BENDING	ANGULAR
1	鎘 (Cd)	<75ppm	X < 8	±0.1	±0.15	±0.3°
2	鉛 (Pb)	<800ppm	8 ≤ X < 25	±0.1	±0.2	±0.5°
3	汞 (Hg)	<800ppm	25 ≤ X < 100	±0.15	±0.25	±0.5°
4	六價鉻 (Cr)	<800ppm	100 ≤ X < 300	±0.2	±0.3	±1°
5	多溴聯苯 (PBB)	<800ppm	300 ≤ X < 800	±0.3	±0.5	±1.5°
6	多溴二苯醚 (PBDE)	<800ppm				
7	總鉛,汞,六價鉻,包裝材料	總含量<10ppm				

***** DRAWING NO.:
 PKE-585-350-116-01
 YL.WANG
 DATE: 16-11-15 SHEET