Seven Segment Displays for High Light Ambient Conditions

Technical Data

**HDSP-3530/-3730/-5530/
-3900 Series**
**HDSP-4030/-4130/-5730/
-4200 Series**

Features

- **High Light Output**
Typical Intensities of Up to 7.0 mcd/seg at 100 mA pk 1 of 5 Duty Factor
- **Capable of High Current Drive**
Excellent for Long Digit String Multiplexing
- **Four Character Sizes**
7.6 mm, 10.9 mm, 14.2 mm, and 20.3 mm
- **Choice of Two Colors**
High Efficiency Red
Yellow
- **Excellent Character Appearance**
Evenly Lighted Segments
Wide Viewing Angle
Gray Body for Optimum Contrast
- **Categorized for Luminous Intensity; Yellow**
Categorized for Color
Use of Like Categories Yields a Uniform Display
- **IC Compatible**
- **Mechanically Rugged**

Description

The HDSP-3530/-3730/-5530/-3900 and HDSP-4030/-4130/-5730/-4200 are 7.6 mm, 10.9 mm/14.2 mm/20.3 mm high efficiency red and yellow displays designed for use in high light ambient condition. The four sizes of displays allow for viewing distances at 3, 6, 7, and 10 meters. These seven segment displays utilize large junction high efficiency LED chips made from GaAsP on a transparent GaP substrate. Due to the large junction area, these displays can be driven at high peak current levels needed for high ambient conditions or many character multiplexed operation.

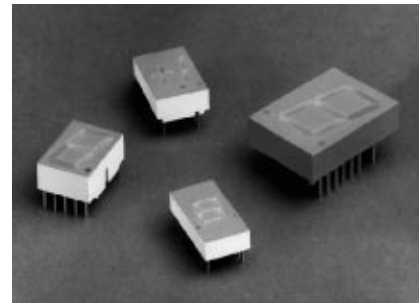

These displays have industry standard packages, and pin configurations and ± 1 overflow display are available in all four sizes. These numeric displays are ideal for applications such as Automotive and Avionic Instrumentation, Point of Sale Terminals, and Gas Pump.

Devices

Part No. HDSP-	Color	Description	Package Drawing
3530	High Efficiency Red	7.6 mm Common Anode Left Hand Decimal	A
3531		7.6 mm Common Anode Right Hand Decimal	B
3533		7.6 mm Common Cathode Right Hand Decimal	C
3536		7.6 mm Universal Overflow ± 1 Right Hand Decimal	D
4030	Yellow	7.6 mm Common Anode Left Hand Decimal	A
4031		7.6 mm Common Anode Right Hand Decimal	B
4033		7.6 mm Common Cathode Right Hand Decimal	C
4036		7.6 mm Universal Overflow ± 1 Right Hand Decimal	D
3730	High Efficiency Red	10.9 mm Common Anode Left Hand Decimal	E
3731		10.9 mm Common Anode Right Hand Decimal	F
3733		10.9 mm Common Cathode Right Hand Decimal	G
3736		10.9 mm Universal Overflow ± 1 Right Hand Decimal	H
4130	Yellow	10.9 mm Common Anode Left Hand Decimal	E
4131		10.9 mm Common Anode Right Hand Decimal	F
4133		10.9 mm Common Cathode Right Hand Decimal	G
4136		10.9 mm Universal Overflow ± 1 Right Hand Decimal	H
5531	High Efficiency Red	14.2 mm Common Anode Right Hand Decimal	I
5533		14.2 mm Common Cathode Right Hand Decimal	J
5537		14.2 mm Overflow ± 1 Common Anode	K
5538		14.1 mm Overflow ± 1 Common Cathode	L
5731	Yellow	14.2 mm Common Anode Right Hand Decimal	I
5733		14.2 mm Common Cathode Right Hand Decimal	J
5737		14.2 mm Overflow ± 1 Common Anode	K
5738		14.1 mm Overflow ± 1 Common Cathode	L
3900	High Efficiency Red	20.3 mm Common Left Hand Decimal	M
3901		20.3 mm Common Anode Right Hand Decimal	N
3903		20.3 mm Common Cathode Right Hand Decimal	O
3905		20.3 mm Common Cathode Left Hand Decimal	P
3906		20.3 mm Universal Overflow ± 1 Right Hand Decimal	Q
4200	Yellow	20.3 mm Common Left Hand Decimal	M
4201		20.3 mm Common Anode Right Hand Decimal	N
4203		20.3 mm Common Cathode Right Hand Decimal	O
4205		20.3 mm Common Cathode Left Hand Decimal	P
4206		20.3 mm Universal Overflow ± 1 Right Hand Decimal	Q

Note: Universal pinout brings the anode and cathode of each segment's LED out to separate pins. See internal diagrams D and H.

Absolute Maximum Ratings (All Products)

Average Power per Segment or DP ($T_A = 25^\circ\text{C}$)	105 mW
Peak Forward Current per Segment or DP ($T_A = 25^\circ\text{C}$)	135 mA (Pulse Width = 0.16 ms)
DC Forward Current per Segment ^[2] or DP ($T_A = 25^\circ\text{C}$)	40 mA
Operating Temperature Range	-40°C to +85°C
Storage Temperature Range	-40°C to +85°C
Reverse Voltage per Segment or DP	5.0 V
Lead Solder Temperature (1.59 mm [1/16 inch] below seating plane)	260°C for 3 sec

Notes:

- See Figure 1 to establish pulsed operating conditions
- Derate maximum DC current above $T_A = 25^\circ\text{C}$ at 0.50 mA/°C per segment, see Figure 2.

Package Dimensions (HDSP-3530/-4030 Series)

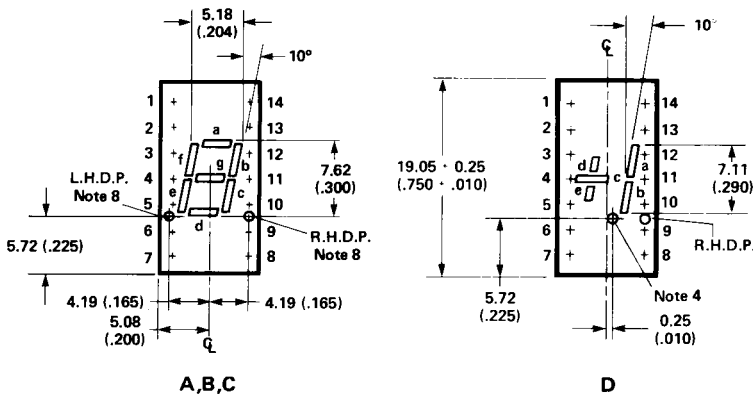

	FUNCTION			
	A -3530/-4030	B -3531/-4031	C -3533/-4033	D -3536/-4036
1	CATHODE-a	CATHODE-a	CATHODE ^[6]	ANODE-d
2	CATHODE-f	CATHODE-f	ANODE-f	NO PIN
3	ANODE ^[3]	ANODE ^[3]	ANODE-g	CATHODE-d
4	NO PIN	NO PIN	ANODE-e	CATHODE-c
5	NO PIN	NO PIN	ANODE-d	CATHODE-e
6	CATHODE-dp	NO CONN. ^[5]	CATHODE ^[6]	ANODE-e
7	CATHODE-e	CATHODE-e	ANODE-dp	ANODE-c
8	CATHODE-d	CATHODE-d	ANODE-c	ANODE-dp
9	NO CONN. ^[5]	CATHODE-dp	ANODE-b	NO PIN
10	CATHODE-c	CATHODE-c	ANODE-a	CATHODE-dp
11	CATHODE-g	CATHODE-g		CATHODE-b
12	NO PIN	NO PIN		CATHODE-a
13	CATHODE-b	CATHODE-b		ANODE-a
14	ANODE ^[3]	ANODE ^[3]		ANODE-b

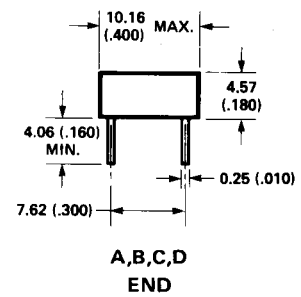
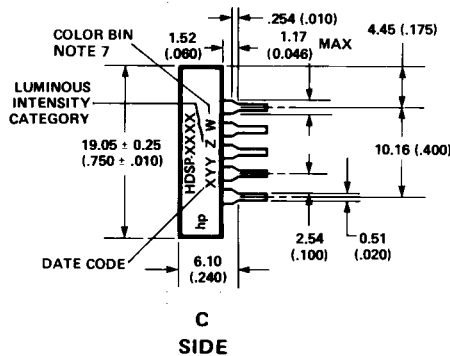
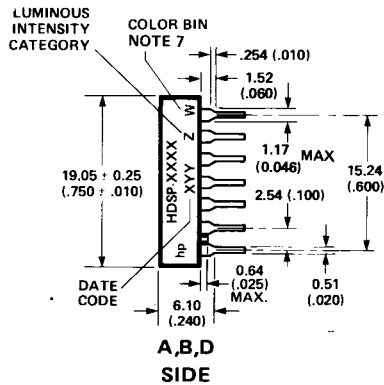

Package Dimensions (HDSP-3730/-4130 Series)

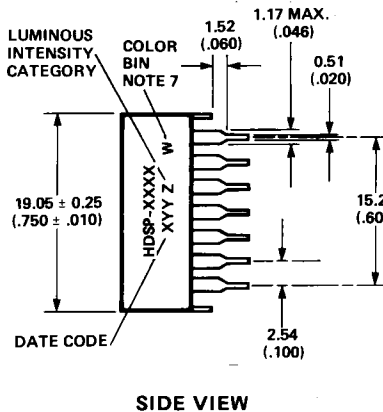
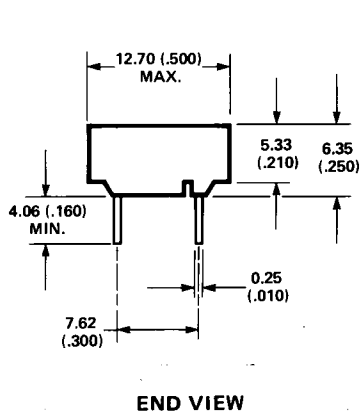
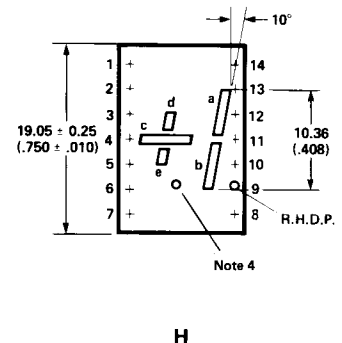
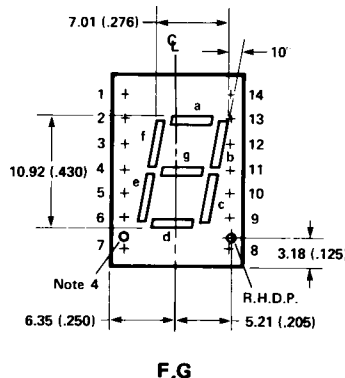
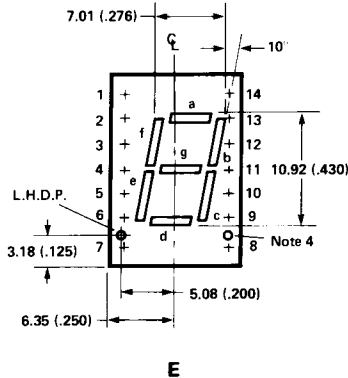

PIN	FUNCTION			
	E -3730/-4130	F -3731/-4131	G -3733/-4133	H -3736/-4136
1	CATHODE-a	CATHODE-a	ANODE-a	CATHODE-d
2	CATHODE-f	CATHODE-f	ANODE-f	ANODE-d
3	ANODE ^[3]	ANODE ^[3]	CATHODE ^[6]	NO PIN
4	NO PIN	NO PIN	NO PIN	CATHODE-c
5	NO PIN	NO PIN	NO PIN	CATHODE-e
6	CATHODE-dp	NO CONN. ^[5]	NO CONN. ^[5]	ANODE-e
7	CATHODE-e	CATHODE-e	ANODE-e	ANODE-c
8	CATHODE-d	CATHODE-d	ANODE-d	ANODE-dp
9	NO CONN. ^[5]	CATHODE-dp	ANODE-dp	CATHODE-dp
10	CATHODE-c	CATHODE-c	ANODE-c	CATHODE-b
11	CATHODE-g	CATHODE-g	ANODE-g	CATHODE-a
12	NO PIN	NO PIN	NO PIN	NO PIN
13	CATHODE-b	CATHODE-b	ANODE-b	ANODE-a
14	ANODE ^[3]	ANODE ^[3]	CATHODE ^[6]	ANODE-b

Package Dimensions (-5530/-5730 Series)

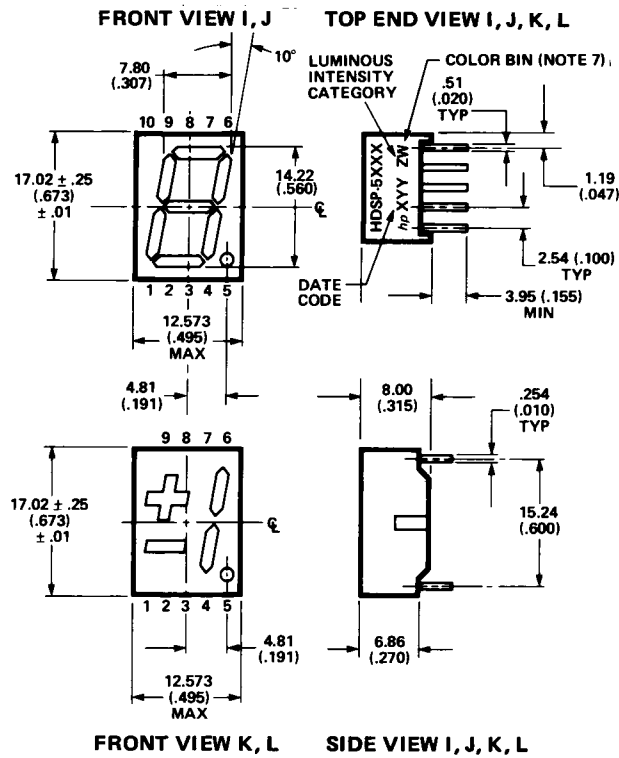

PIN	FUNCTION			
	I 5531	J 5533	K 5537	L 5538
1	CATHODE e	ANODE e	CATHODE c	ANODE c
2	CATHODE d	ANODE d	ANODE c, d	CATHODE c, d
3	ANODE ⁽³⁾	CATHODE ⁽⁶⁾	CATHODE b	ANODE b
4	CATHODE c	ANODE c	ANODE a, b, DP	CATHODE a, b, DP
5	CATHODE DP	ANODE DP	CATHODE DP	ANODE DP
6	CATHODE b	ANODE b	CATHODE a	ANODE a
7	CATHODE a	ANODE a	ANODE a, b, DP	CATHODE a, b, DP
8	ANODE ⁽³⁾	CATHODE ⁽⁶⁾	ANODE c, d	CATHODE c, d
9	CATHODE f	ANODE f	CATHODE d	ANODE d
10	CATHODE g	ANODE g	NO PIN ⁽⁵⁾	NO PIN ⁽⁵⁾

Package Dimensions (-3900/-4200 Series)

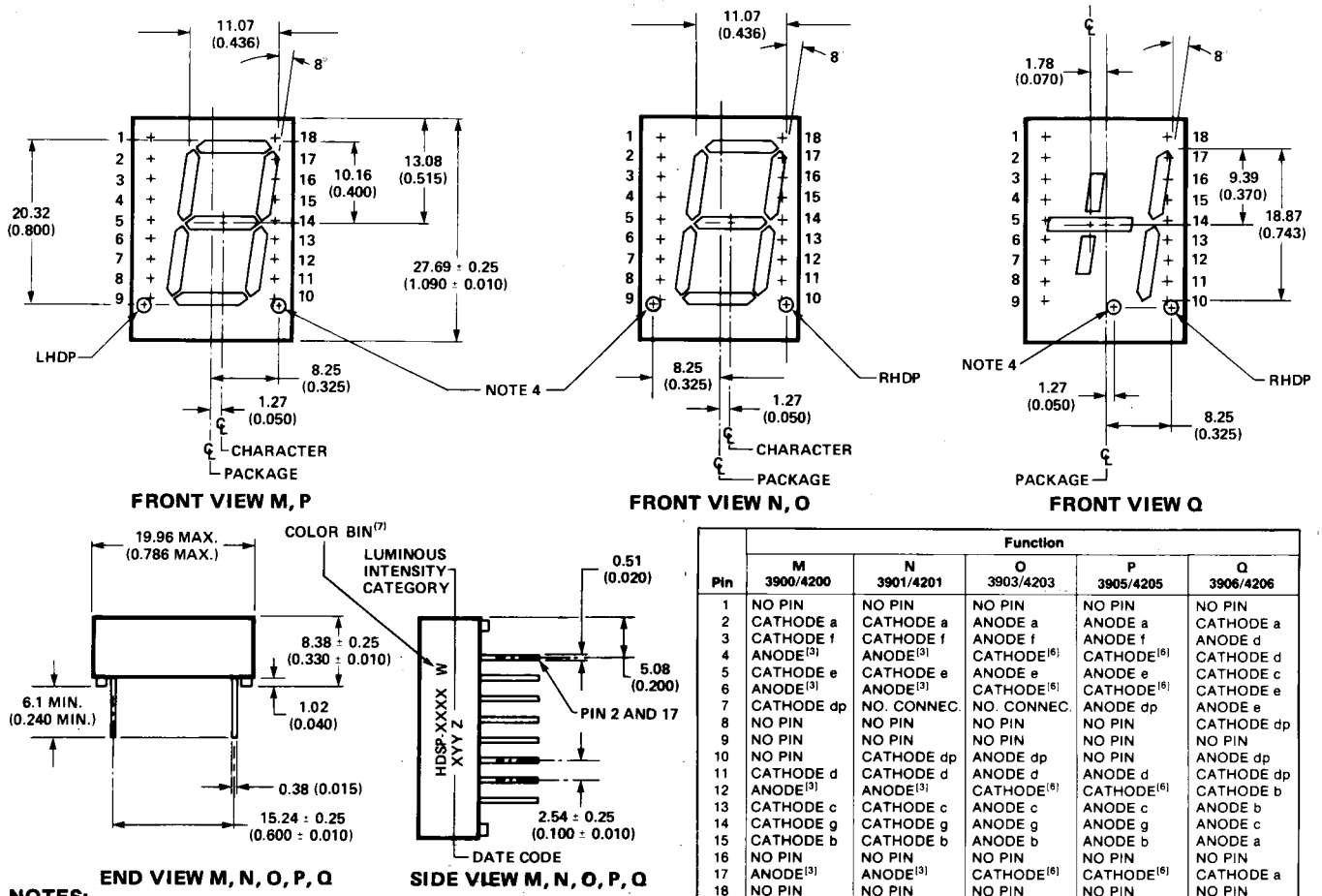

Pin	Function				
	M 3900/4200	N 3901/4201	O 3903/4203	P 3905/4205	Q 3906/4206
1	NO PIN	NO PIN	NO PIN	NO PIN	NO PIN
2	CATHODE a	CATHODE a	ANODE a	ANODE a	CATHODE a
3	CATHODE f	CATHODE f	ANODE f	ANODE f	ANODE d
4	ANODE ⁽³⁾	ANODE ⁽³⁾	CATHODE ⁽⁶⁾	CATHODE ⁽⁶⁾	CATHODE d
5	CATHODE e	CATHODE e	ANODE e	ANODE e	CATHODE c
6	ANODE ⁽³⁾	ANODE ⁽³⁾	CATHODE ⁽⁶⁾	CATHODE ⁽⁶⁾	CATHODE e
7	CATHODE dp	NO CONNEC.	NO CONNEC.	ANODE dp	ANODE e
8	NO PIN	NO PIN	NO PIN	NO PIN	CATHODE dp
9	NO PIN	NO PIN	NO PIN	NO PIN	NO PIN
10	NO PIN	CATHODE dp	ANODE dp	NO PIN	ANODE dp
11	CATHODE d	CATHODE d	ANODE d	ANODE d	CATHODE dp
12	ANODE ⁽³⁾	ANODE ⁽³⁾	CATHODE ⁽⁶⁾	CATHODE ⁽⁶⁾	CATHODE b
13	CATHODE c	CATHODE c	ANODE c	ANODE c	ANODE b
14	CATHODE g	CATHODE g	ANODE g	ANODE g	ANODE c
15	CATHODE b	CATHODE b	ANODE b	ANODE b	ANODE a
16	NO PIN	NO PIN	NO PIN	NO PIN	NO PIN
17	ANODE ⁽³⁾	ANODE ⁽³⁾	CATHODE ⁽⁶⁾	CATHODE ⁽⁶⁾	CATHODE a
18	NO PIN	NO PIN	NO PIN	NO PIN	NO PIN

NOTES:

- Dimensions in millimeters and (inches).
- All untoleranced dimensions are for reference only.
- Redundant anodes.
- Unused dp position.
- See Internal Circuit Diagram.
- Redundant Cathodes.
- For HDSP-4030/-4130/-5731/-4200 Series product only.
- See part number table for LHDP and RHDP designation.

Internal Circuit Diagram (HDSP-3530/-4030 Series)

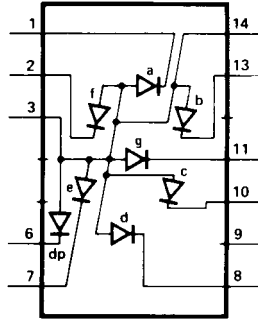

A

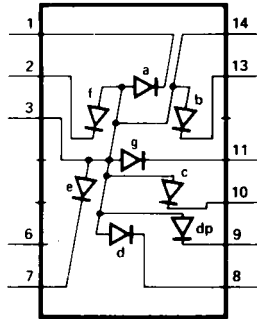

B

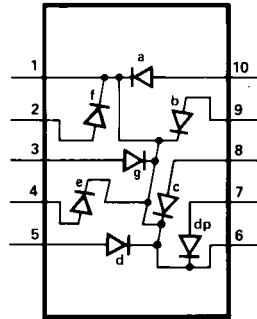

C

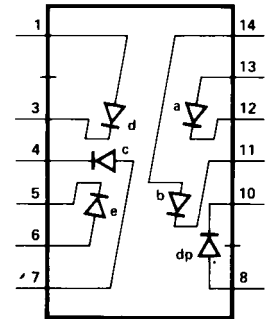

D

Internal Circuit Diagram (HDSP-3730/-4130 Series)

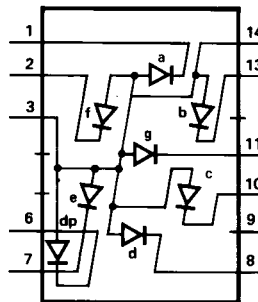

E

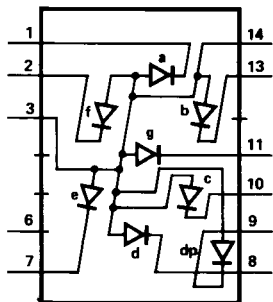

F

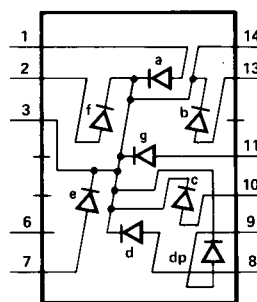

G

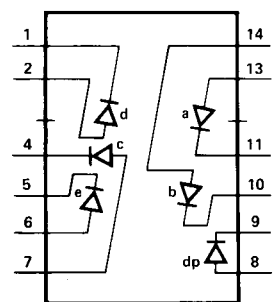

H

Internal Circuit Diagram (HDSP-5530/-5730 Series)

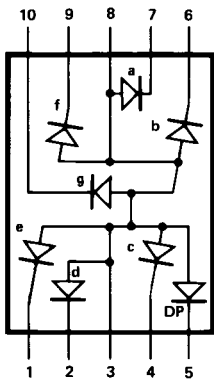

I

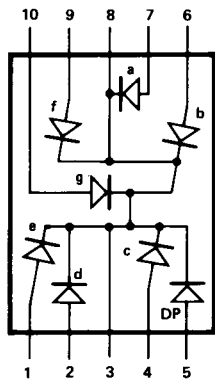

J

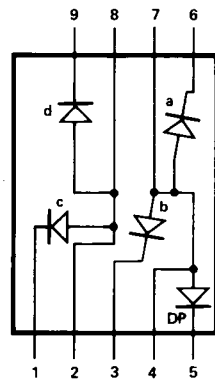

K

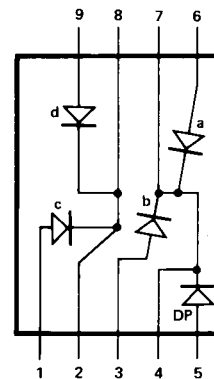

L

Internal Circuit Diagram (HDSP-3900/-4200 Series)

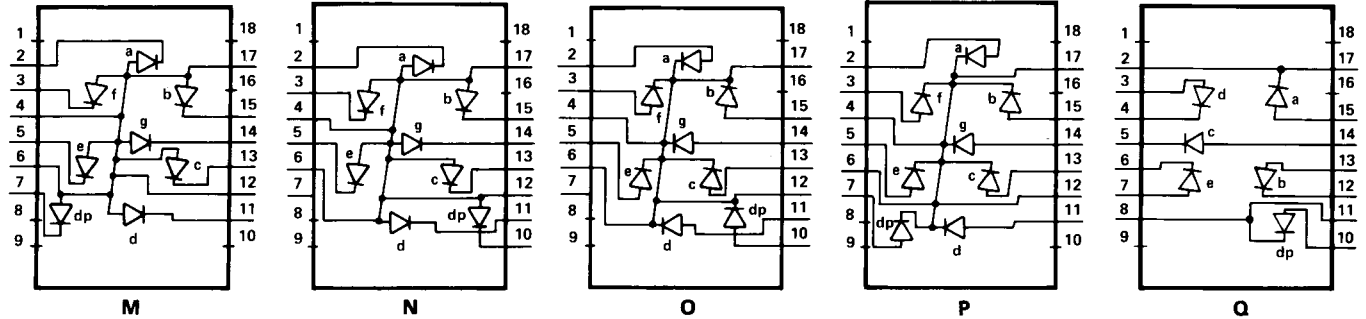

Electrical/Optical Characteristics at $T_A = 25^\circ\text{C}$

Parameter	Sym.	Device HDSP-	Min.	Typ.	Max.	Units	Test Condition
Luminous Intensity/ Segment ^[9,10] (Digit Average)	I_V	3530	1500	4500		μcd	100 mA Pk; 1 of 5 Duty Factor
		3730	1500	5000			
		5530	2200	7000			
		3900	2200	7000			
		3530		3100		μcd	20 mA DC
		3730		3500			
		5530		4800			
		3900		4800			
Peak Wavelength	λ_{PEAK}	4030	1500	4500		μcd	100 mA Pk; 1 of 5 Duty Factor
		4130	1500	5000			
		5730	2200	7000			
		4200	2200	7000			
Dominant Wavelength ^[11,12] (Digit Average)	λ_d	4030		2200		μcd	20 mA DC
		4130		2500			
		5730		3400			
		4200		3400			
Forward Voltage/Seg or D.P.	V_F	All Devices		2.6	3.5	V	$I_F = 100 \text{ mA}$
Reverse Current/Seg or D.P.	I_R	All Devices			100	μA	$V_R = 3.0 \text{ V}$
Temp. Coeff. of V_F /Seg or D.P.	$\Delta V_F/^\circ\text{C}$	All Devices		-1.1		$\text{mV}/^\circ\text{C}$	$I_F = 100 \text{ mA}$
Thermal Resistance LED Junction-to-Pin	$R\theta_{\text{J-PIN}}$	3530/4030/ 3730/4130		282		$^\circ\text{C}/\text{W}/\text{Seg}$	
		5530/5730		345		$^\circ\text{C}/\text{W}/\text{Seg}$	
		3900/4200		375		$^\circ\text{C}/\text{W}/\text{Seg}$	

Notes:

- 9. Case temperature of the device immediately prior to the intensity measurement is 25°C .
- 10. The digits are categorized for luminous intensity with the intensity category designated by a letter on the side of the package.
- 11. The dominant wavelength, λ_d , is derived from the CIE chromaticity diagram and is that single wavelength which defines the color of the device.
- 12. The yellow displays are categorized as to dominant wavelength with the category designated by a number adjacent to the intensity category letter.

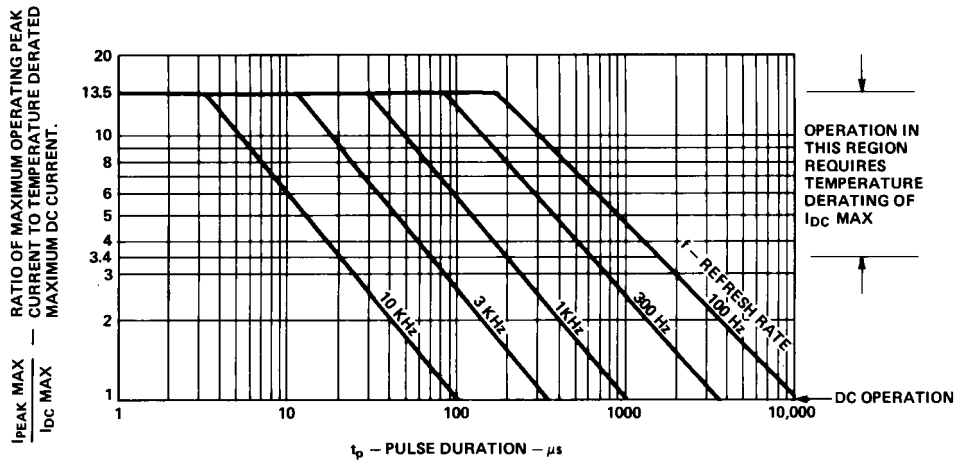

Figure 1. Maximum Allowed Peak Current vs. Pulse Duration.

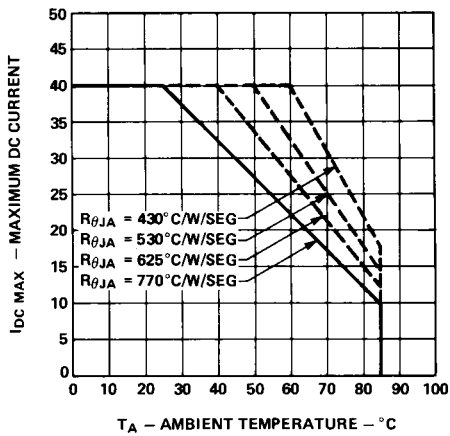

Figure 2. Maximum Allowable DC Current per Segment vs. Ambient Temperature.

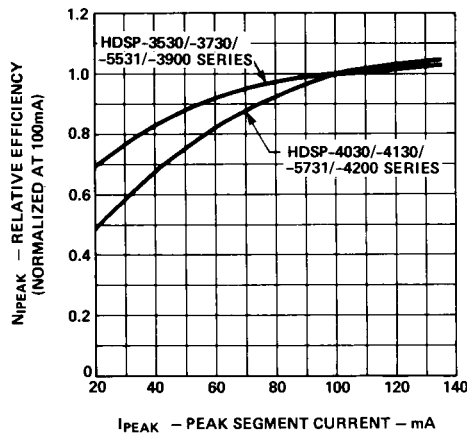

Figure 3. Relative Efficiency (Luminous Intensity per Unit Current) vs. Peak Segment Current.

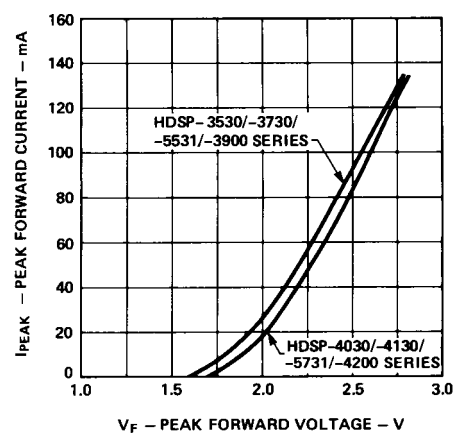

Figure 4. Peak Forward Segment Current vs. Peak Forward Voltage.

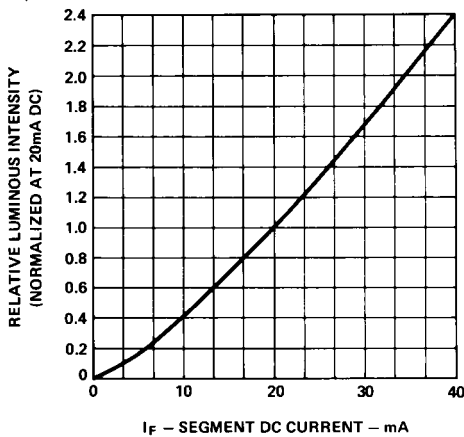

Figure 5. Relative Luminous Intensity vs. DC Forward Current.

Electrical

These display devices are composed of eight light emitting diodes, with light from each LED optically stretched to form individual segments and a decimal point.

The devices utilize LED chips which are made from GaAsP on a transparent GaP substrate.

These display devices are designed for strobed operation. The typical forward voltage values, scaled from Figure 4, should be used for calculating the current limiting resistor value and typical power dissipation.

Expected maximum V_F values, for the purpose of driver circuit design and maximum power dissipation, may be calculated using the following V_F MAX models:

$$V_F \text{ MAX} = 2.15 \text{ V} + I_{\text{PEAK}} (13.5 \Omega)$$

For: $I_F \geq 30 \text{ mA}$

$$V_F \text{ MAX} = 1.9 \text{ V} + I_{\text{DC}} (21.8 \Omega)$$

For: $10 \text{ mA} \leq I_F \leq 30 \text{ mA}$

Temperature derated strobed operating conditions are obtained from Figures 1 and 2. Figure 1 relates pulse duration (t_p), refresh rate (f), and the ratio of maximum peak current to maximum

dc current ($I_{PEAK\ MAX}/I_{DC\ MAX}$). Figure 2 presents the maximum allowed dc current vs. ambient temperature. Figure 1 is based on the principle that the peak junction temperature for pulsed operation at a specified peak current, pulse duration and refresh rate should be the same as the junction temperature at maximum DC operation. Refresh rates of 1 kHz or faster minimize the pulsed junction heating effect of the device resulting in the maximum possible time average luminous intensity.

The time average luminous intensity can be calculated knowing the average forward current and relative efficiency characteristic, $\eta_{|PEAK}$, of Figure 3. Time average luminous intensity for a device case temperature of 25°C, I_V (25°C), is calculated as follows:

$$I_V(25^\circ\text{C}) = \left[\frac{I_{AVG}}{20\ \text{mA}} \right] [\eta_{|PEAK}] [I_{V\ \text{DATA SHEET}}]$$

Example: For HDSP-4030 series

$\eta_{|PEAK} = 1.00$ at $I_{PEAK} = 100\ \text{mA}$.
For $DF = 1/5$:

$$I_V(25^\circ) = \left[\frac{20\ \text{mA}}{20\ \text{mA}} \right] [1.00][4.5\ \text{mcd}]$$

$$= 4.5\ \text{mcd/segment}$$

The time average luminous intensity may be adjusted for operating junction temperature by the following exponential equation:

$$I_V(T_J) = I_V(25^\circ\text{C}) e^{k(T_J + 25^\circ\text{C})}$$

where $T_J = T_A + P_D \cdot R_{\theta J-A}$

Device	K
-3530/-3730/ -5530/-3900	-0.0131/°C
-4030/-4130/ -5730/-4200	-0.0112/°C

Mechanical

These devices are constructed utilizing a lead frame in a standard DIP package. The LED dice are attached directly to the lead frame. Therefore, the cathode leads are the direct thermal and mechanical stress paths to the LED dice. The absolute maximum allowed junction temperature, $T_J\ MAX$, is 105°C. The maximum power ratings have been established so that the worst case V_F device does not exceed this limit.

Worst case thermal resistance pin-to-ambient is 400°C/W/Seg when these devices are soldered into minimum trace width PC boards. When installed in a PC board that provides $R_{\theta\ \text{PIN-A}}$ less than 400°C/W/Seg these displays may be operated at higher average currents as shown in Figure 2.

Optical

The radiation pattern for these devices is approximately Lambertian. The luminous sterance may be calculated using one of the two following formulas.

$$L_V(\text{cd/m}^2) = \frac{I_V(\text{cd})}{A(\text{m}^2)}$$

$$L_V(\text{footlamberts}) = \frac{\pi I_V(\text{cd})}{A(\text{ft}^2)}$$

Device	Area/Seg. mm ²	Area/Seg. in ²
-3530/-4030	2.5	0.0039
-3730/-4130	4.4	0.0068
-5530/-5730	8.8	0.0137
-3900/-4200	14.9	0.0231

Contrast Enhancement

The objective of contrast enhancement is to optimize display readability. Adequate contrast enhancement can be achieved in indoor applications through luminous contrast techniques. Luminous contrast is the observed brightness of the illuminated segment compared to the brightness of the surround. Appropriate wavelength filters maximize luminous contrast by reducing the amount of light reflected from the area around the display while transmitting most of the light emitted by the segment. These filters are described further in Application Note 1015.

Chrominance contrast can further improve display readability. Chrominance contrast refers to the color difference between the illuminated segment and the surrounding area. These displays are assembled with a gray package and untinted encapsulating epoxy in the segments to improve chrominance contrast of the ON segments. Additional contrast enhancement in bright ambients may be achieved by using a neutral density gray filter such as Panelgraphic Chromafilter Gray 10, or 3M Light Control Film (louvered film).